

Scan to connect online to the most up-to-date version of this Section of SPEEDFAX.



contents

Siemens TPS3 family of hardwired Surge Protective Devices (formally known as Surge/Lightning Arrestors and/or Transient Voltage Surge Suppressors –TVSS)

Family SPDs	10-2
SOLID Protection	10-3
First Surge	10-4 – 10-5
TPS3 01 and TPS3 L1 (10 Mode)	10-6
TPS3 02 and TPS3 L2 (10 Mode)	10-7
TPS3 03	10-8
TPS3 03 DC	10-9
TPS3 05 and TPS3 L5 (10 Mode)	10-10
TPS3 06 and TPS3 L6 (10 Mode)	10-11
TPS3 09	10-12
TPS3 11	10-13
TPS3 12 and TPS3 L12 (10 mode)	10-14
TPS3 15 and TPS3 L15 (10 mode)	10-15
Frequently Asked Questions	10-16

Integrally Mounted SPDs



Features

- Per Phase Surge Current Capacity ranging from 100 kA to 1000 kA
- Industry best VPRs
- $I_n = 20$ kA (most models)
- Across the board UL 96A compliance (most models)
- Ground Reference Monitoring (GRM) diagnostics

External or Wall Mounted SPDs



Features

- Per Phase Surge Current Capacity ranging from 50 kA to 1000 kA
- Industry best VPRs
- $I_n = 20$ kA (most models)
- Across the board UL 96A compliance (most models)
- Ground Reference Monitoring (GRM) diagnostics (excluding TPS3 03 & TPS3 09)

Residential SPDs



See pages 1-46 – 1-48

Features

- Per Phase Surge Current Capacity of 40, 50, 60, 100 or 140 kA
- Complete Service Protection for
 - Power
 - Telephone
 - Coax
- Ground Reference Monitoring (GRM) diagnostics

SPD - Surge Protective Devices

Siemens Surge Protection Innovations

Introduction

In today's electronic world, home and business electrical systems just aren't complete unless they incorporate surge protection. **Stopping Surges Before They Get Into** these systems is best accomplished through the installation of appropriately sized hard-wired surge protective devices (SPDs) beginning at the incoming service followed by installations at other key surge entry points.

When Siemens first developed the Transient Protection System (TPS) family of surge protectors, we knew early on that hard-wired surge protectors needed fully coordinated safety controls. This led to the adoption of a number of SPD

industry safety control firsts including the patented Ceramgard and TranSafe circuitry, coordinated fusing and thermal cutouts, dielectric isolation, mechanical re-enforcing taping, etc... resulting in a design that ensures the highest possible electrical system surge protection and reliability.











Our next generation UL 1449 4th Edition TPS3 SPDs carry on this same legacy. Every TPS3 is infused with Siemens engineering safety and performance "know-how." Siemens SPDs have the highest degree of safety while delivering the industry's best performance ratings – some of the lowest Voltage Protection







Ratings (VPRs), Type 1 or 2 and 20 kA I-nominal ratings (for most models) with surge current ratings from 50 to 1000 kA.

Electrical disturbances will always occur, but they don't have to cause surge protectors to fail in an unsafe manner. Safer surge protection means uncompromised electrical system **protection, safety, and reliability.**

The following pages provide additional technical and ordering information concerning our TPS3 family of Surge Protective Devices (SPDs).

Surge Protector Per Phase Surge Current Capacities

Wall Mounted Standard Mode										
Per Phase Surge Current	TPS3 01	TPS3 02	TPS3 03	TPS3 03 DC	TPS3 05	TPS3 06	TPS3 09	TPS3 11	TPS3 12	TPS3 15
50 kA										
100 kA										
150 kA										
200 kA										
250 kA										
300 kA										
400 kA										
500 kA										
600 kA										
800 kA										
1000 kA										

10 Mode SPDs									
Per Phase Surge Current	TSP3 L1	TPS3 L2		TPS3 L5	TPS3 L6			TPS3L 12	TPS3L 15
100 kA									
150 kA									
300 kA									
450 kA									
500 kA									
600 kA									
900 kA									

SPD - Surge Protective Devices

Recommending Surge Protection

SOLID Protection

Either at home or in the work place, nearly every electrical load is electronic infused. With today's power quality being the same as it was 50 years ago, equipment is more susceptible to surge damage and/or disruption generated by normal electrical distribution interactions. Places where lightning activity is minimal are now experiencing more electronic failures due to surges

generated by the day to day operations of equipment like washers and dryers, copiers, chillers, etc.

In response to this susceptibility, code authorities have mandated emergency power distribution equipment now must be protected by a listed SPD. The reasoning is based upon anecdotal understating that surge protected systems are more reliable. Supported by

government studies, the most efficient way to protect electrical systems from surges is through the installation of hardwired SPDs at key points throughout the distribution system. These locations can easily be remembered by memorizing the locations of the acronym found within the following phrase, "The best surge protected system is a SOLID one," where each letter of the word SOLID stand for the locations on the electrical system where SPDs should be installed.

The illustration to the right shows "SOLID" locations for a school's electrical system. Under each 'SOLID' location is a Siemens TPS3 model number with surge current capacities matching those to what are typically specified by consultants across North America.



TPS30620
or
TPS31220

Service
Entrance



TPS30515
or
TPS31215

Outside loads
like Parking
Lot Lighting
powered
from
distribution
panels

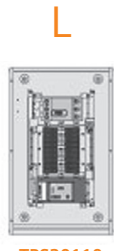

TPS30110
or
TPS31110

Lower voltage
distribution
panels
powering
computers
and other
electronics



TPS31110
or
TPS30910

Individual
critical
equipment
like servers



TPS30350
or
Call TPS Group

Data,
telephone,
and coaxial
cables

Surge Arrestor Replacement



TPS3 03
Type 1 SPD
with $I_n = 20$ kA

Low-voltage surge and lightning arrestors became obsolete when UL 1449 3rd edition went into effect in 2009.

They were replaced with Type 1 SPDs having an I-nominal (I_n) rating equal to 20 kA. Most all Siemens TPS3s are rated as Type 1, $I_n=20$ kA SPDs. However, the style and form factor of traditional surge arrestors is best replaced using our TPS3 03.

Discrete or True 10 Mode Style SPDs

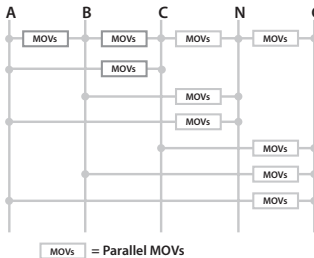

For mission critical or high profile applications, a growing number of end users prefer the assurance discrete or true 10-mode SPDs provide.

When surges traverse the electrical system via phase to phase conductors, standard SPDs indirectly protect via the line to neutral or line to ground modes of protection. Siemens integral or wall mounted "Discrete" or "True" 10-mode SPDs address L-L surges by incorporating directly connected line to line surge protection elements. This style of SPD provides the "Just in Case" assurance mission critical or high profile projects require.

FirstSurge™ Total Home Surge Protection



Total Home Protection

Siemens believes today's residential surge protectors come up short when protecting today's modern home filled with smart appliances and electronics. This is why we developed our FirstSurge™ commercial class total home surge protectors. These electrical system surge protectors are sized for where you live. They will let you know when there is something wrong or when they are worn out.

Based upon thunderstorm frequency, geographic location, and home size, we developed a surge exposure map correlating with FirstSurge™ current capacities known to provide years of protective service for each shaded area.

Sized For Where You Live

Model	Surge Capacity
FirstSurge™ Power (FS060)	60,000 A
FirstSurge™ Plus (FS100)	100,000 A
FirstSurge™ Pro (FS140)	140,000 A

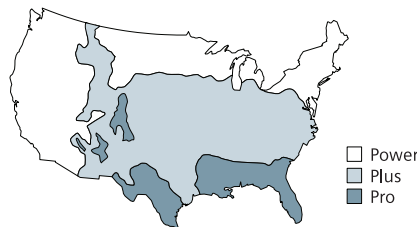

Know You're Protected: 3 Stage Commercial Grade Notification

When there is a problem, Siemens FirstSurge™ takes the guesswork out of knowing when it is time to be replaced. What will you see and hear when this occurs?

- Audible Alarm: Beeps
- Green LED(s): Extinguish
- Red Service Light: Flashes

Ground Reference Monitoring (GRM)

FirstSurge™ is GRM-equipped notifying you a rare safety hazard exists due to a compromised electrical system neutral to ground bond. What will you see and hear when this occurs?

- Audible Alarm: Beeps
- Green LED(s): Remains Lit
- Red Service Light: Flashes



SPD - Surge Protective Devices

FirstSurge

Features & Benefits

- UL 1449 Listed, Type 2, Surge Protective Device (SPD)
- Rated for 120/240 split phase panels up to 400A
- Surge Current Capacities:
 - 60,000 A
 - 100,000 A
 - 140,000 A
- 3 Stage Commercial Grade Notification
- Ground Reference Monitoring (GRM)
- Installs onto any brand load center
- Type 4 rated outdoor enclosure
- 10 year product and connected equipment warranty*

*See warranty for details

Installation Instructions:

FirstSurge™ is a Type 2 SPD. It is suitable for use downstream of the service disconnect.

Pre-Plan your installation. You need to accomplish the following:

- Meet all National and Local codes (NEC® Article 285 and UL 1449 address SPDs).
- Confirm System voltage to SPD voltage (120V SPD will fail instantly on 240V, 277V, etc.).
- Mount SPD as close to panel or equipment as possible to keep leads short. (long leads hurt performance).
- Ensure leads are as short and straight as possible, including neutral and ground. Use a breaker position that is close to the SPD and the panel's neutral and ground.
- Recommended breaker size is 20A.
- Make sure system is grounded per NEC® and clear of faults before energizing SPD. (inadvertent system problem may fail SPD).
- Never Hi-Pot test Any SPD. (will prematurely fail SPD).

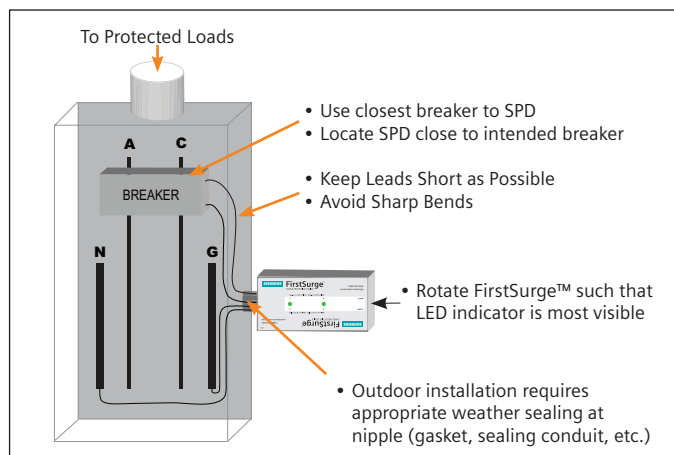

Technical Specifications	
Surge Spike Capacity	FirstSurge™ Power (FS060) 60,000 A
	FirstSurge™ Plus (FS100) 100,000 A
	FirstSurge™ Pro (FS140) 140,000 A
Line Voltage	120/240 Split Phase, 50/60 Hz
UL 1449 3rd Ed VPR	L-N: 600 V
	L-G: 600 V
	N-G: 600 V
	L-L: 900 V
Rated Voltage (MCOV)	150V – L-N, L-G, and N-G; 300V – L-L
Response Time	<1 nanosecond
Enclosure	NEMA 4X Indoor and Outdoor Rated
Selection Information	
FirstSurge™ Power	FS060
FirstSurge™ Plus	FS100
FirstSurge™ Pro	FS140
FirstSurge™ Flush Mount Kit	XMFMKIT

1. Use voltmeter to check voltages and ensure correct SPD. See Data Sheet for specs and wire-outs.
2. Determine Mounting location – weather resistant equipment may be required.
3. If SPD has optional Flush Mount Kit, pre-plan its installation. See Figure 3. (If flush mounting, be careful to not drop SPD into wall).
4. Remove power from panel/source. Confirm panel/source is deenergized.
5. Identify breaker location and SPD location. Position SPD such that LEDs are best visible. If Flush Mount Kit was ordered, follow Flush Mount instructions and then proceed at #6.
6. Mount SPD – weather resistant applications require additional sealing, etc. (not included)
 - Remove an appropriately sized knockout from panel.
 - Connect conductors as appropriate – short and straight as possible.
7. Label or mark conductors as appropriate (neutral: white, ground: green, energized: black).
8. Make sure system is bonded per NEC® and is clear of hazards or faults before energizing (N-G bonding not per NEC® will fail SPDs: #1 cause of SPD failures).
9. Energize and confirm proper operation of green LED indicators. If any connected phase LED does not illuminate, remove power, check all connections and test again. If any connected phase LED still does not illuminate, contact Siemens Technical Support at: 1-888-333-3545.
10. The SPD is equipped with an audible alarm which will sound in the event of an alarm condition. This indicates a problem with the SPD which requires further evaluation. There is no test or silence switch. De-energizing the SPD will silence the alarm.

SPD - Surge Protective Devices

TPS3 Integral or Internally Mounted SPDs

Selection

TPS3 01 and TPS3 L1 (True or Discrete 10-Mode)

Siemens TPS3 01 and L1 surge protective devices are designed for integration within our P1, P2, and P3 power distribution panel boards, as well as TIASTAR motor control centers and busway systems. The TPS3 01 and L1 SPDs feature Ground Integrity Monitoring (GIM) diagnostics

TPS3 01 and TPS3 L1 Key Features

- UL 1449-4 Type 2 SPD and UL 1283 Listed
 - Optional UL 1449 4th Edition Listed Type 1
- Type 1 / Type 2 SPD
- 100 - 300 kA Per Phase Surge Current
- 20 kA I_n (Most models)
- 200 kA SCCR (Most models)
- UL 96A Lightning Protection Master Labeling compliant (@ 20 kA)
- Large block, individually fused, thermally protected, 50kA MOVs
- Every MOV is monitored, including N-G
- Mounts internal to:
 - P1, P2, and P3 panels
 - TIASTAR motor control centers – standard 6" bucket
 - STP series busplug on SX series busway
- Consult factory for field retrofit in P1 panels
- Modes of Protection: L-N, L-G, N-G, and L-L
- All UL required OCP & safety coordination included
 - Type 1 SPDs intended for Line or Load side of Main Disconnect
 - Type 2 SPDs intended for Load side of Main Disconnect
- Standard Monitoring: LED Indicators, Surge Counter, Dry Contacts, Audible Alarm w/ silence switch & test button
- Dimensions: 11.5" x 7.2" x 4.5"
(292.1 mm x 182.9 mm x 114.3 mm)
- Weight: 4.55 lb. (2.06 kg)
- Designed, manufactured & tested consistent with:
 - ANSI / IEEE C62.41.1-2002, C62.41.2-2002, C62.45-2002, C62.62-1010, C62.72-2007 and CSA C22.2 No. 269.1 and 269.2
 - 1992/2000 NEMA LS-1
 - NEC Article 285
 - IEC 61643, CE
- 10 Year Product Warranty

Available Options:

- Direct bus connected or can be wired to a circuit breaker (include W option)

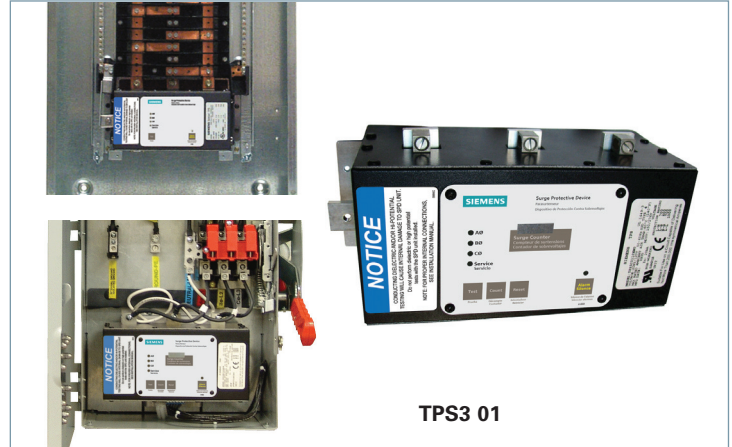

Ordering Information

Catalog # TPS3 01

Voltage Code	Surge Current (kA)	Options
A = 120/240 V, 1Ø, 3W	10 = 100 kA per phase	X = Surge counter (Standard)
B = 120/240 V, 3Ø, 4W	15 = 150 kA per phase	W = Terminal lug
C = 120/208 V, 3Ø, 4W	20 = 200 kA per phase	B = Busway application
D = 240 V, 3Ø, 3W	25 = 250 kA per phase	M = MCC application
E = 277/480 V, 3Ø, 4W	30 = 300 kA per phase	
F = 480 V, 3Ø, 3W		
G = 600 V, 3Ø, 3W [Ⓛ]		
K = 380/220 V, 3Ø, 4W		
L = 600/347 V, 3Ø, 4W		
S = 400/230 V, 3Ø, 4W		

Example: **TPS3C0120X002** = Type 2 SPD (Default) for a 208/120V panelboard with a surge current capacity of 200 kA per phase and a surge counter.

When an option is not selected, include a **zero (0)** in the field.

Available Accessories: Ordered Separately

RMSIE = Remote monitor
[Ⓛ] Available in 100 kA & 150 kA only



Ordering Information

Catalog # TPS3 L1

Voltage Code	Surge Current (kA)	Options
A = 120/240 V, 1Ø, 3W	15 = 150 kA per phase	X = Surge counter (Standard)
B = 120/240 V, 3Ø, 4W	30 = 300 kA per phase	W = Terminal lug
C = 120/208 V, 3Ø, 4W		B = Busway application
E = 277/480 V, 3Ø, 4W		M = MCC application
K = 380/220 V, 3Ø, 4W		
S = 400/230 V, 3Ø, 4W		

Example: **TPS3CL130X002** = 10 Mode Type 2 SPD (Default) for a 208/120V panelboard with a surge current capacity of 300 kA per phase and a surge counter.

When an option is not selected, include a **zero (0)** in the field.

Available Accessories: Ordered Separately

RMSIE = Remote monitor

SPD - Surge Protective Devices

TPS3 Integral or Internally Mounted SPDs

Selection

TPS3 02 and TPS3 L2 (True or Discrete 10-Mode)

Siemens TPS3 02 and L2 surge protective devices are designed for integration within our Revised P1 power distribution panel boards. The TPS3 01 and L1 SPDs feature Ground Integrity Monitoring (GIM) diagnostics.

TPS3 02 and TPS3 L2 Key Features

- UL 1449-4 Type 2 SPD and UL 1283 Listed
 - Optional UL 1449 4th Edition Recognized Type 1
- Type 1 / Type 2 SPD
- 100 - 300 kA Per Phase Surge Current
- Large block, individually fused, thermally protected, 50kA MOVs
- 20 kA I_n (Most models)
- 200 kA SCCR (Most models)
- UL 96A Lightning Protection Master Labeling compliant (@ 20 kA)
- Large block, individually fused, thermally protected, 50kA MOVs
- Every MOV is monitored, including N-G
- Mounts internal to:
 - Revised P1 Lighting Panelboards
- Consult factory for field retrofit in P1 panels
- Modes of Protection: L-N, L-G, N-G, and L-L
- All UL required OCP & safety coordination included
 - Type 1 SPDs intended for Line or Load side of Main Disconnect
 - Type 2 SPDs intended for Load side of Main Disconnect
- Standard Monitoring: LED Indicators, Surge Counter, Dry Contacts, Audible Alarm w/ silence switch & test button
- Dimensions: 11.6" x 5.7" x 4.9"
(294.6 mm x 144.8 mm x 124.5 mm)
- Weight: 4.55 lb. (2.06 kg)
- 10 Year Product Warranty

Available Options:

- Direct bus connected
Can be wired to a circuit breaker (consult factory at time of order or see installation manual for retrofit)

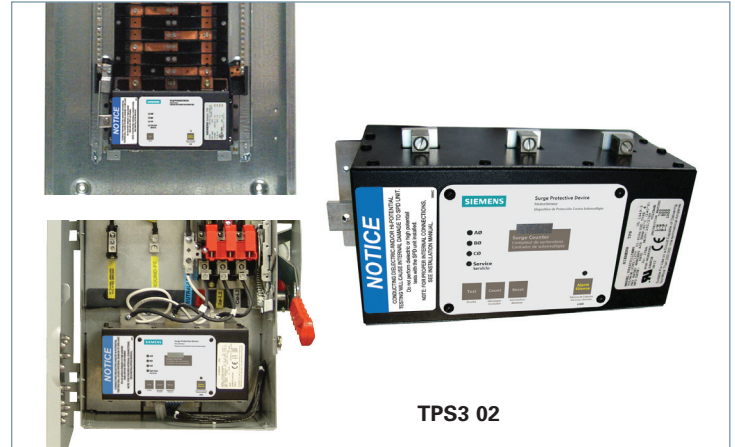

TPS3 02

Ordering Information

Catalog # TPS3 02

Voltage Code	Surge Current (kA)	Options
A = 120/240 V, 1Ø, 3W	10 = 100 kA per phase	X = Surge counter (Standard)
B = 120/240 V, 3Ø, 4W	15 = 150 kA per phase	2 = Type 2 SPD (Default)
C = 120/208 V, 3Ø, 4W	20 = 200 kA per phase	Includes UL 1283 EMI/RFI Filters
D = 240 V, 3Ø, 3W	25 = 250 kA per phase	0 = Type 1 SPD
E = 277/480 V, 3Ø, 4W	30 = 300 kA per phase	(Consult Factory Prior to Ordering)
F = 480 V, 3Ø, 3W		
G = 600 V, 3Ø, 3W [Ⓢ]		
K = 380/220 V, 3Ø, 4W		
L = 600/347 V, 3Ø, 4W		
S = 400/230 V, 3Ø, 4W		

Example: **TPS3C0220X2** = Type 2 SPD (Default) for a 208/120V panelboard with a surge current capacity of 200 kA per phase and a surge counter.
When an option is not selected, include a **zero (0)** in the field.

Available Accessories: Ordered Separately

RMSIE = Remote monitor
Ⓢ Available in 100kA & 150 kA only

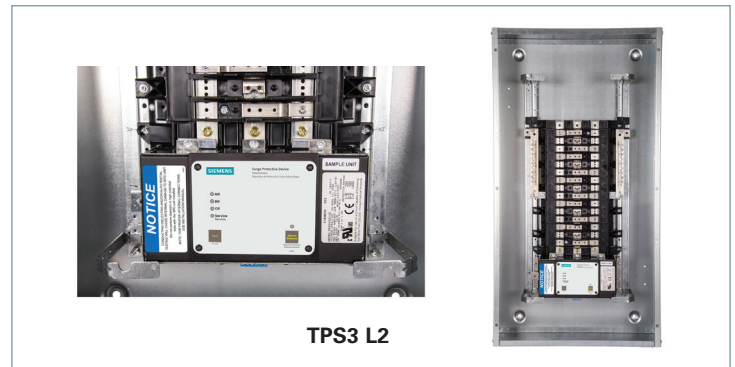

TPS3 L2

Ordering Information

Catalog # TPS3 L2

Voltage Code	Surge Current (kA)	Options
A = 120/240 V, 1Ø, 3W	15 = 150 kA per phase	X = Surge counter (Standard)
B = 120/240 V, 3Ø, 4W	30 = 300 kA per phase	2 = Type 2 SPD (Default)
C = 120/208 V, 3Ø, 4W		Includes UL 1283 EMI/RFI Filters
E = 277/480 V, 3Ø, 4W		0 = Type 1 SPD
K = 380/220 V, 3Ø, 4W		(Consult Factory Prior to Ordering)
S = 400/230 V, 3Ø, 4W		

Example: **TPS3CL230X2** = 10 Mode Type 2 SPD (Default) for a 208/120 V panelboard with a surge current capacity of 300 kA per phase and a surge counter.
When an option is not selected, include a **zero (0)** in the field.

Available Accessories: Ordered Separately

RMSIE = Remote monitor

SPD - Surge Protective Devices

TPS3 03

TPS3 03 is a UL 1449 4th Edition 50 kA Type 1 compact surge protective device that can be used as a replacement secondary surge or lightning arrestors. Having a Type 1 designation allows for flexible electrical system connection location (line or load side) as well as UL 96A compliance (@ 20 kA I_{n}).

TPS3 03 Key Features

- UL 1449 4th Edition Listed Type 1
- Type 1 Rated SPD
- 50 kA Per Phase Surge Current
- 20 kA I_{n} (Most models)
- 200 kA SCCR (Most models)
- UL 96A Lightning Protection Master Labeling compliant (@ 20 kA)
- Every MOV is monitored
- Mounts external to electrical distribution equipment
 - Recommend for Line Side or Load Side Applications
- Standard compact NEMA 4X polycarbonate enclosure
- Modes of Protection: L-N or L-G and L-L
- Standard Monitoring: LED Indicator
- Dimensions: 3.25" x 3.25" x 3.3" (82.6 mm x 82.6 mm x 83.8 mm)
- Weight: 2 lb. (0.9 kg)
- 2 Year Product Warranty

Available Options:

- Dry contacts & Audible Alarm (option "D")
- Neutral to Ground Protection (option "N")



Ordering Information

Catalog # **TPS3** **03**

<p>Voltage Code</p> <p>A = 120/240 V, 1Ø, 3W B = 120/240 V, 3Ø, 4W C = 120/208 V, 3Ø, 4W D = 240 V, 3Ø, 3W E = 277/480 V, 3Ø, 4W F = 480 V, 3Ø, 3W G = 600 V, 3Ø, 3W K = 380/220 V, 3Ø, 4W L = 600/347 V, 3Ø, 4W</p>	<p>Surge Current (kA)</p> <p>05 = 50 kA per phase</p>	<p>Options</p> <p>D = Dry contact & audible alarm</p> <p>N = Adds N-G Protection</p>
-----------------------------------------------------------------------------------------------------------------------------------------------------------------------------------------------------------------------------------------------------------------------------------------------------------------------------------------------------------------------------------------------------	--------------------------------------------------------------	-------------------------------------------------------------------------------------------------

Example: **TPS3C0305D0** = Type 1 SPD for a 208/120V application with a surge current capacity of 50 kA per phase, in a standard NEMA 4X enclosure with dry contacts and audible alarm option.

When an option is not selected, include a **zero (0)** in the field.

Available Accessories: Ordered Separately

RMSIE = Remote monitor

SPD - Surge Protective Devices

TPS3 External or Wall Mounted SPDs

Selection

TPS3 03 DC

TPS3 03 DC is available in 300VDC, 600VDC and 1000VDC versions, which are designed to protect photovoltaic electrical systems. Typical PV installation would be on the DC solar panel side and also on the AC side of the inverter/converter. AC voltage TPS3 03's are also available. SPDs are highly recommended when lightning activity is present to protect sensitive electrical photovoltaic components.

TPS3 03 DC is designed as a stand alone device in a NEMA 4X polycarbonate enclosure. Large block, thermally protected 50 kA MOVs are utilized. A green LED illuminates for diagnostic monitoring. TPS3 03 DC comes standard with a Tri-Mount installation kit which allows it to be Nipple, DIN-rail or Bracket mounted.



Ordering Information

Catalog # **TPS3** **0305**

Voltage Code **M** = 300 VDC **P** = 1000 VDC **R** = 600 VDC

Diagram

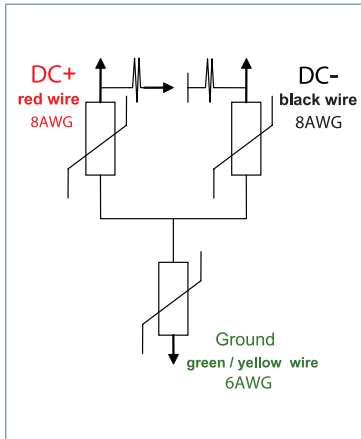

Dimensions

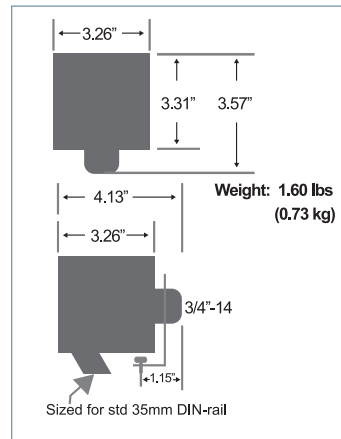

Tri-Mount Installation

Mounting Kit Included

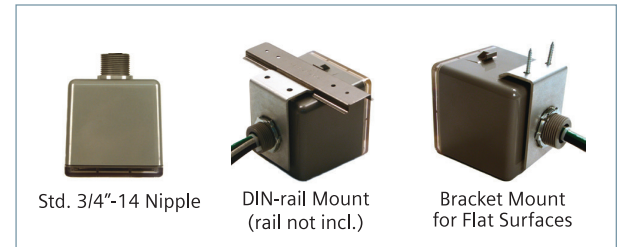

Performance Data

Siemens Part Number		TPS3M0305	TPS3R0305	TPS3P0305
Modes of Protection		DC+ – DC- , DC+ – Ground, DC- – Ground		
Nominal Network Voltage	U_n	300VDC	600VDC	1000VDC
Technology		Large Block, Thermally Protected 50kA MOVs		
Maximum Continuous Operating Voltage DC	U_c	425VDC	760VDC	1180VDC
Maximum Surge Current (8/20 μ s)	I_{max}	50kA	50kA	50kA
Nominal Discharge Current (8/20 μ s)	I_n	20kA	20kA	10kA
Voltage Protection Level (3kA 8/20 μ s)	U_p	<600V	<1800V	<2500V
Operating Temperature		-40oC + 65oC		
Response Time	t_A	<1ns		
Installation mounting method		DIN Rail, Nipple or Bracket		
Enclosure Material		NEMA 4X Polycarbonate		
Wiring (red = + , black = - , green / yellow = gnd)		Pre-wired w/3' (~1m) of 8AWG + 6AWG Ground Conductor		
Diagnostic circuit		Low Consumption LED Indicator		
Safety Disconnectors		Thermal/Overcurrent Protection; Arc-Breaking Slide Gate		
UL Listing		UL 1449 Listed as Type 1 SPD as a DC SPD for PV and other types of DC applications		
Warranty		5 Years		

SPD - Surge Protective Devices

TPS3 Integral or Internally Mounted SPDs

Selection

TPS3 05 and TPS3 L5 (True or Discrete 10-Mode)

Siemens TPS3 05 and L5 surge protective devices are designed for integration within our P4 and P5 panelboards as well as distribution switchboards. The TPS3 01 and L1 SPDs feature Ground Integrity Monitoring (GIM) diagnostics.

TPS3 05 and TPS3 L5 Key Features

- UL 1449-4 Type 2 SPD and UL 1283 Listed
 - Optional UL 1449 4th Edition Listed Type 1
- Type 1 / Type 2 SPD
- 100 - 300 kA Per Phase Surge Current
- 20 kA I_n (Most models)
- 200 kA SCCR (Most models)
- UL 96A Lightning Protection Master Labeling compliant (@ 20 kA)
- Large block, individually fused, thermally protected, 50kA MOVs
- Every MOV is monitored, including N-G
- Mounts internal to:
 - P4 & P5 panelboards and distribution switchboards
- Modes of Protection: L-N, L-G, N-G, and L-L
- All UL required OCP & safety coordination included
 - Type 1 SPDs intended for Line or Load side of Main Disconnect
 - Type 2 SPDs intended for Load side of Main Disconnect
- Standard Monitoring: LED Indicators, Surge Counter, Dry Contacts, Audible Alarm w/ silence switch & test button
- Dimensions: 10" x 17" x 6" (254 mm x 431.8 mm x 152.4 mm)
- Weight: 9.4 lb. (4.2 kg)
- Designed, manufactured & tested consistent with:
 - ANSI / IEEE C62.41.1-2002, C62.41.2-2002, C62.45-2002, C62.62-1010, C62.72-2007 and CSA C22.2 No. 269.1 and 269.2
 - 1992/2000 NEMA LS-1
 - NEC Article 285
 - IEC 61643, CE
- 10 Year Product Warranty

Panelboard Features:

- Copper or aluminum bus MB or MLO

Switchboard Features:

- Copper or aluminum bus
- 200% rated neutral bus for harmonic-rich applications
- CSA, UL 891, UL 67 and NEMA PB-2

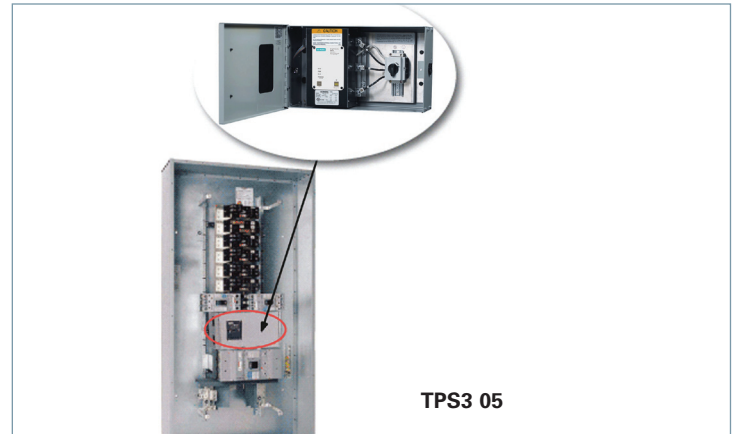

TPS3 05

Ordering Information

Catalog # **TPS3** **05**

Voltage Code	Surge Current (kA)	Options
A = 120/240 V, 10, 3W	10 = 100 kA per phase	X = Surge counter (Standard)
B = 120/240 V, 30, 4W	15 = 150 kA per phase	2 = Type 2 SPD (Default)
C = 120/208 V, 30, 4W	20 = 200 kA per phase	Includes UL 1283 EMI/RFI Filters
D = 240 V, 30, 3W	25 = 250 kA per phase	0 = Type 1 SPD
E = 277/480 V, 30, 4W	30 = 300 kA per phase	(Consult Factory Prior to Ordering)
F = 480 V, 30, 3W		
G = 600 V, 30, 3W [Ⓛ]		
K = 380/220 V, 30, 4W		
L = 600/347 V, 30, 4W		
S = 400/230 V, 30, 4W		

Example: **TPS3C0530X2** = Type 2 SPD (Default) for a 208/120V power panel with a surge current capacity of 300 kA per phase and a surge counter. When an option is not selected, include a **zero (0)** in the field.

Available Accessories: Ordered Separately

RMSIE = Remote monitor

[Ⓛ] Available in 100 kA & 150 kA only

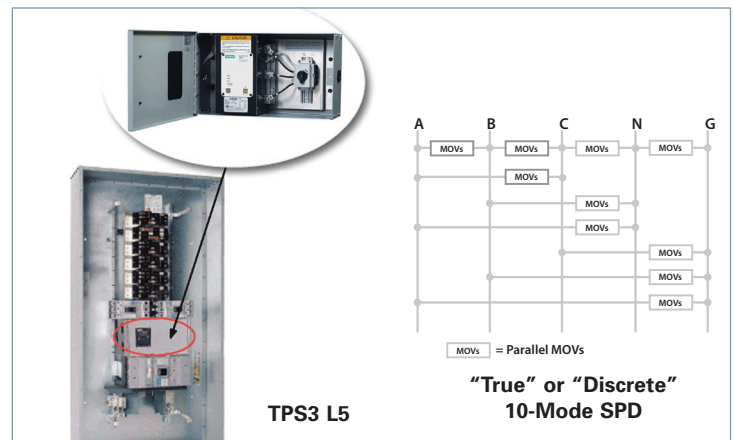

TPS3 L5

"True" or "Discrete" 10-Mode SPD

Ordering Information

Catalog # **TPS3** **L5**

Voltage Code	Surge Current (kA)	Options
A = 120/240 V, 10, 3W	15 = 150 kA per phase	X = Surge counter (Standard)
B = 120/240 V, 30, 4W	30 = 300 kA per phase	2 = Type 2 SPD (Default)
C = 120/208 V, 30, 4W		Includes UL 1283 EMI/RFI Filters
E = 277/480 V, 30, 4W		0 = Type 1 SPD
K = 380/220 V, 30, 4W		(Consult Factory Prior to Ordering)
S = 400/230 V, 30, 4W		

Example: **TPS3C0530X2** = Type 2 SPD (Default) for a 208/120V power panel with a surge current capacity of 300 kA per phase and a surge counter. When an option is not selected, include a **zero (0)** in the field.

Available Accessories: Ordered Separately

RMSIE = Remote monitor

SPD - Surge Protective Devices

TPS3 Integral or Internally Mounted SPDs

Selection

TPS3 06 and TPS3 L6 (True or Discrete 10-Mode)

Siemens TPS3 06 and L6 surge protective devices are designed for integration within our SB1, SB2, SB3, Type RCS Switchboards, Low-voltage Switchgear, Motor Control Centers, and Busway Systems. The TPS3 01 and L1 SPDs feature Ground Integrity Monitoring (GIM) diagnostics.

TPS3 06 and TPS3 L6 Key Features

- UL 1449-4 Type 2 SPD and UL 1283 Listed
 - Optional UL 1449 4th Edition Listed Type 1
- Type 1 / Type 2 SPD
- 100 - 500 kA Per Phase Surge Current
- 20 kA I_n (Most models)
- 200 kA SCCR (Most models)
- UL 96A Lightning Protection Master Labeling compliant (@ 20 kA)
- Large block, individually fused, thermally protected, 50kA MOVs
- Every MOV is monitored, including N-G
- Mounts internal to:
 - SB1, SB2, SB3 and Type RCS Switchboards
 - Type WL low-voltage switchgear
 - TIASTAR motor control centers - standard 12" bucket
 - STP series busplug on SX series busway
- Modes of Protection: L-N, L-G, N-G, and L-L
- All UL required OCP & safety coordination included
 - Type 1 SPDs intended for Line or Load side of Main Disconnect
 - Type 2 SPDs intended for Load side of Main Disconnect
- Standard Monitoring: LED Indicators, Surge Counter, Dry Contacts, Audible Alarm w/ silence switch & test button, Rotary disconnect switch
- Dimensions: 10.7" x 11.5" x 4.5"
(271.8 mm x 292.1 mm x 114.3 mm)
- Weight: 6.8 lb. (3.0 kg)
- Designed, manufactured & tested consistent with:
 - ANSI / IEEE C62.41.1-2002, C62.41.2-2002, C62.45-2002, C62.62-1010, C62.72-2007 and CSA C22.2 No. 269.1 and 269.2
 - 1992/2000 NEMA LS-1
 - NEC Article 285
 - IEC 61643, CE
- Designed, manufactured & tested consistent with:
 - ANSI / IEEE C62.41.1-2002, C62.41.2-2002, C62.45-2002, C62.62-1010, C62.72-2007 & CSA C22.2 No. 269.1 and .2
 - 1992/2000 NEMA LS-1
 - NEC Article 285
 - IEC 61643, CE
- 10 Year Product Warranty

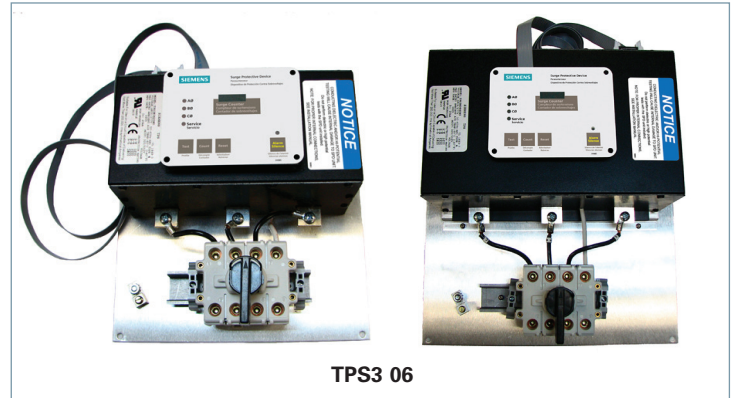

TPS3 06

Ordering Information

Catalog # **TPS3** **06**

Voltage Code	Surge Current (kA)	Options
A = 120/240 V, 1Ø, 3W	10 = 100 kA per phase	X = Surge counter (Standard)
B = 120/240 V, 3Ø, 4W	15 = 150 kA per phase	B = Busway application
C = 120/208 V, 3Ø, 4W	20 = 200 kA per phase	M = MCC application
D = 240 V, 3Ø, 3W [Ⓞ]	25 = 250 kA per phase	
E = 277/480 V, 3Ø, 4W	30 = 300 kA per phase	
F = 480 V, 3Ø, 3W [Ⓞ]	40 = 400 kA per phase	
G = 600 V, 3Ø, 3W [Ⓞ]	50 = 500 kA per phase	
K = 380/220 V, 3Ø, 4W		
L = 600/347 V, 3Ø, 4W		
S = 400/230 V, 3Ø, 4W		

Example: **TPS3C0120X002** = Type 2 SPD (Default) for a 208/120V panelboard with a surge current capacity of 200 kA per phase and a surge counter.

When an option is not selected, include a **zero (0)** in the field.

Available Accessories: **Ordered Separately**

RMSIE = Remote monitor
[Ⓞ] G voltage code only available in 200 & 250 kA
[Ⓢ] Not available in 500 kA

2 = Type 2 SPD (Default) Includes UL 1283 EMI/RFI Filters
 0 = Type 1 SPD (Consult Factory Prior to Ordering)

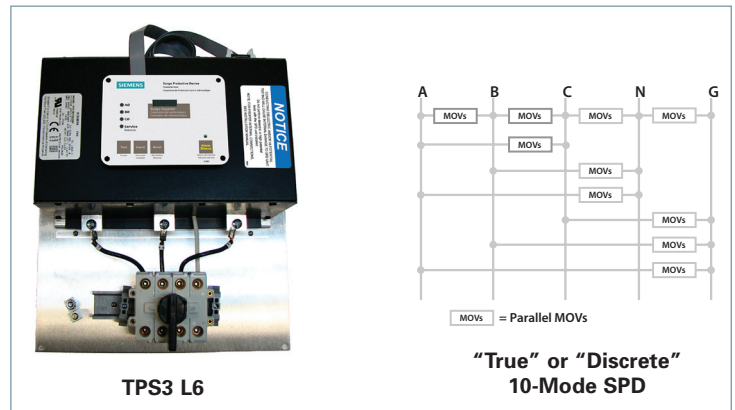

TPS3 L6

"True" or "Discrete" 10-Mode SPD

Ordering Information

Catalog # **TPS3** **L6**

Voltage Code	Surge Current (kA)	Options
A = 120/240 V, 1Ø, 3W	15 = 150 kA per phase	X = Surge counter (Standard)
B = 120/240 V, 3Ø, 4W	30 = 300 kA per phase	B = Busway application
C = 120/208 V, 3Ø, 4W	45 = 450 kA per phase	M = MCC application
E = 277/480 V, 3Ø, 4W		
K = 380/220 V, 3Ø, 4W		
S = 400/230 V, 3Ø, 4W		

Example: **TPS3CL645X2** = 10 mode Type 2 SPD (Default) for a 208/120V switchboard with a surge current capacity of 450 kA per phase and a surge counter.

When an option is not selected, include a **zero (0)** in the field.

Available Accessories: **Ordered Separately**

RMSIE = Remote monitor

2 = Type 2 SPD (Default) Includes UL 1283 EMI/RFI Filters
 0 = Type 1 SPD (Consult Factory Prior to Ordering)

10 SPD

SPD - Surge Protective Devices

TPS3 External or Wall Mounted SPDs

Selection

TPS3 09

TPS3 09 is a UL 1449 4th Edition 100 kA Type 1 compact multi-mode surge protective device that can be installed on either the line or load side of the electrical service. When installed at the electrical service entrance, it can be used for UL 96A compliance (@ 20 kA I_n).

TPS3 09 Key Features

- UL 1449 4th Edition Listed Type 1
- Type 1 Rated SPD
- 100 kA Per Phase Surge Current
- 20 kA I_n (Most models)
- 200 kA SCCR (Most models)
- UL 96A Lightning Protection Master Labeling compliant (@ 20 kA)
- Every MOV is monitored, including N-G
- Mounts external to electrical distribution equipment
 - Weatherproof hub included
- Mounts internal to P1 panelboards & busway
 - P1 - Field retrofit or factory install
 - P2 and P3 - factory install only
- Standard compact NEMA 4X polycarbonate enclosure
- Modes of Protection: L-N, L-G, N-G, and L-L
- Standard Monitoring: LED Indicators
- Wire Size: Prewired with 3' (91.4 cm) of #10 AWG
- Dimensions: 8.3" x 3.6" x 3.0" (211 mm x 91 mm x 77 mm)
- Weight: 3 lb. (1.4 kg)
- 10 Year Product Warranty

Available Options:

- Dry contacts & Audible Alarm (option "D")
- Extended indicator light (option "E")
- Internal mounting in P1, P2 Panels (option "I"), requires TPS9IKITP1 or TPS9IKITP2 mounting bracket accessory.



TPS3 09

Ordering Information

Catalog # **TPS3**

Voltage Code	Surge Current (kA)	Options
A = 120/240 V, 1Ø, 3W	10 = 100 kA per phase	E = Extended indicator light
B = 120/240 V, 3Ø, 4W		I = Internal mounting in P1, P2 panels ^①
C = 120/208 V, 3Ø, 4W		D = Dry Contact & audible alarm
D = 240 V, 3Ø, 3W		
E = 277/480 V, 3Ø, 4W	Example: TPS3C0910D000	
F = 480 V, 3Ø, 3W	= Type 1 SPD for a 208/120V panelboard with a surge current capacity of 100 kA per phase with standard NEMA 4X enclosure, dry contacts and audible alarm option.	
G = 600 V, 3Ø, 3W	Available for field retrofit in P1 panels.	
K = 380/220 V, 3Ø, 4W		
L = 600/347 V, 3Ø, 4W		
S = 400/230 V, 3Ø, 4W		

When an option is not selected, include a **zero (0)** in the field.

Available Accessories: Ordered Separately

- RMSIE** = Remote monitor
- XMFMKIT** = Flush mount plate
- TPS9IKITP1** = Mounting bracket for installation in P1 panels
- TPS9IKITP2** = Mounting bracket for installation in P2 panels (factory install only)

^① Requires TPS9IKITP1 or TPS9IKITP2 mounting bracket accessory, see available Accessories. Prewired cables are extended from 3 to 6 feet.

SPD - Surge Protective Devices

TPS3 External or Wall Mounted SPDs

Selection

TPS3 11

TPS3 11 is a UL 1449 3rd Edition Listed multi-mode Type 1 surge protective device with a per phase surge current capacity that can be increased to 200 kA. In addition, this unit provides UL 1283 listed EMI/RFI or Sine Wave tracking filtering that will condition low energy L-N coupled noise. When installed at the electrical service entrance, it can be used for UL 96A compliance (@ 20 kA I_n).

Standard monitoring includes protection status indication LEDs. Complete protection is intact when the status indicators are illuminated. When protection is lost, the status indicator will extinguish and the red service light will illuminate. An audible alarm and dry contacts are available monitoring options.

A new diagnostic feature integrated within the TPS3 11 is Ground Integrity Monitoring or (GIM) diagnostic indication circuit. Ground Integrity Monitoring or (GIM) diagnostics monitors the health of the electrical system's neutral to ground bond. If voltage is seen across neutral and ground, the phase indicators will remain illuminated, while the red service light begins to flash alerting the end user that the electrical system grounding needs to be checked and serviced. This feature can be remotely monitored when the optional dry contacts are included. Siemens TPS3s are one of the first in the industry to offer this power quality safety and performance indication.

TPS3 11 Key Features

- UL 1449-4 Type 2 SPD and UL 1283 Listed – Optional UL 1449 4th Edition Listed Type 1
- Type 1 / Type 2 SPD
- 100, 150, 200 kA Per Phase Surge Current
- 20 kA I_n (Most models)
- 200 kA SCCR (Most models)
- UL 96A Lightning Protection Master Labeling compliant (@ 20 kA)
- Every MOV is monitored, including N-G
- Mounts external to electrical distribution equipment
- Standard NEMA 4X polycarbonate enclosure (UL 746C (f1), UL 94-5VA)
- Modes of Protection: L-N, L-G, N-G, and L-L
- Standard Monitoring: LED Indicators and Ground Integrity Monitoring diagnostics
- Wire size: #8 AWG to #10 AWG
- Dimensions: 6" x 6" x 4" (152 mm x 152 mm x 102 mm)
- Weight: 5 lb. (2.27 kg)
- 10 Year Product Warranty

Available Options:

- Dry contacts & Audible Alarm (option "D")



TPS3 11

Ordering Information

Catalog # **TPS3** **11**

<p>Voltage Code</p> <p>A = 120/240 V, 1Ø, 3W B = 120/240 V, 3Ø, 4W C = 120/208 V, 3Ø, 4W D = 240 V, 3Ø, 3W E = 277/480 V, 3Ø, 4W F = 480 V, 3Ø, 3W G = 600 V, 3Ø, 3W[Ⓢ] K = 380/220 V, 3Ø, 4W L = 600/347 V, 3Ø, 4W S = 400/230 V, 3Ø, 4W</p>	<p>Surge Current (kA)</p> <p>10 = 100 kA per phase 15 = 150 kA per phase 20 = 200 kA per phase</p> <p>Example: TPS3C1110D2 = Type 2 SPD (Default) for a 208/120V application with a surge current capacity of 100 kA per phase, in a standard NEMA 4X enclosure with dry contacts and audible alarm option.</p> <p>When option D is NOT selected, include a zero (0) in the field.</p>	<p>Options</p> <p>2 = Type 2 SPD (Default) Includes UL 1283 EMI/RFI Filters 0 = Type 1 SPD (Consult Factory Prior to Ordering) D = Dry Contacts & audible alarm</p>
------------------------------------------------------------------------------------------------------------------------------------------------------------------------------------------------------------------------------------------------------------------------------------------------------------------------------------------------------------------------------------	----------------------------------------------------------------------------------------------------------------------------------------------------------------------------------------------------------------------------------------------------------------------------------------------------------------------------------------------------------------------------------------------------------------------------------------------	---------------------------------------------------------------------------------------------------------------------------------------------------------------------------------------------------------------

Available Accessories: Ordered Separately

RMSIE = Remote monitor
KITFMXF = Flush mount plate

[Ⓢ] Available in 100 kA per phase only

SPD - Surge Protective Devices

TPS3 External or Wall Mounted SPDs

Selection

TPS3 15 and TPS3 L15 (True or Discrete 10-Mode)

TPS3 15 and TPS3 L15 are UL 1449-4 Type 2 and Optional UL 1449 4th Edition surge protective device with a per phase surge current capacity that can be increased to 1000 kA (TPS3 L15 up to 900 kA). For mission critical or high profile applications, the TPS3 L15 is our "True" or "Discrete" 10-mode style SPD providing the "Just in Case" assurance of directly connected L-L MOVs.

Both TPS3 15 and TPS3 L15 are UL 1283 Listed incorporating EMI/RFI or Sine Wave tracking filtering designed to condition low energy L-N coupled noise. When installed at the electrical service entrance, it can be used for UL 96A compliance (@ 20 kA I_n).

Standard monitoring includes protection status indication LEDs, audible alarm, and dry contacts. Complete protection is intact when the status indicators are illuminated. When protection is lost, the status indicator will extinguish, the red service light will illuminate, and the dry contacts will change state. An optional surge counter is available.

A new diagnostic feature integrated within the TPS3 15 and TPS3 L15 is Ground Integrity Monitoring or (GIM) diagnostic indication circuit. Ground Integrity Monitoring or (GIM) diagnostics monitors the health of the electrical system's neutral to ground bond. If voltage is seen across neutral and ground, the phase indicators will remain illuminated, while the red service light begins to flash alerting the end user that the electrical system grounding needs to be checked and serviced. This feature can be remotely monitored via the dry contact outputs. Siemens TPS3s are one of the first in the industry to offer this power quality safety and performance indication.

TPS3 15 and TPS3 L15 Key Features

- UL 1449-4 and UL 1283 Listed
 - Optional UL 1449 4th Edition Listed Type 1
- Type 1 / Type 2 SPD
- TPS3 15: 400 – 1000 kA Per Phase Surge Current
- TPS3 L15: 600 and 900 kA Phase Surge Current
- 20 kA I_n (Most models)
- 200 kA SCCR (Most models)
- UL 96A Lightning Protection Master Labeling compliant (@ 20 kA)
- Every MOV is monitored, including N-G
- Mounts external to electrical distribution equipment
 - Recommended for line side or load side applications
- Standard NEMA 1/12/3R/04 ANSI 61 steel enclosure
- TPS3 15 Modes of Protection – L-N, L-G, N-G, and L-L
- TPS3 L15 Modes of Protection – L-N, L-G, N-G, and L-L (directly connected L-L elements)
- Internal rotary disconnect switch included
- Standard Monitoring:
 - LED Indicators
 - Ground Integrity Monitoring diagnostics
 - Dry Contacts
 - Audible alarm with silence switch and test button
- Wire size: #8 AWG to 1/0
- Dimensions: 20" x 20" x 7" (508 mm x 508 mm x 178 mm)^④
- Weight: 64 lb. (29 kg)^④
- 10 Year Product Warranty

Available Options:

- Thru-door disconnect



TPS3 15

Ordering Information

Catalog # TPS3 15

Voltage Code	Surge Current (kA)	Enclosure	Options
A = 120/240 V, 1Ø, 3W	40 = 400 kA per phase ^①	0 = Standard NEMA	2 = Type 2 SPD (Default) Includes UL 1283 EMI/RFI Filters
B = 120/240 V, 3Ø, 4W	50 = 500 kA per phase ^①	1/12/3R/4 Steel	0 = Type 1 SD (Consult Factory Prior to Ordering)
C = 120/208 V, 3Ø, 4W	60 = 600 kA per phase	V = NEMA 4X non-metallic	T = Thru-door disconnect
D = 240 V, 3Ø, 3W ^②	80 = 800 kA per phase	S = NEMA 4X stainless steel	X = Surge Counter (Standard)
E = 277/480 V, 3Ø, 4W	1K = 1000 kA per phase	F = NEMA 1 flush mount	
F = 480 V, 3Ø, 3W ^③		P = NEMA 1 screwcover pullbox with extended display on 5ft cable for line side mounting in SWBD/SWGR	
G = 600 V, 3Ø, 3W ^③			
K = 380/220 V, 3Ø, 4W			
L = 600/347 V, 3Ø, 4W			
S = 400/230 V, 3Ø, 4W			

Example: **TPS3C1560SX02** = Type 2 SPD (Default) for a 208/120V application with a surge current capacity of 600 kA per phase, in a NEMA 4X stainless steel enclosure with a surge counter and standard disconnect switch.

When an option is NOT selected, include a zero (0) in the field.

Available Accessories: Ordered Separately

RMSIE = Remote monitor
 ① Available in G voltage code only
 ② Available in 600 kA & 800 kA only
 ③ Available in 400 kA & 500 kA only

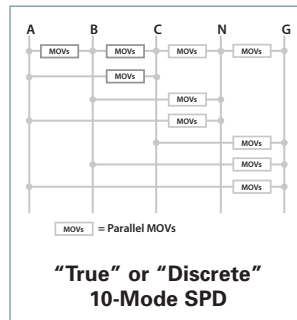

TPS3 L15

Ordering Information

Catalog # TPS3 L15

Voltage Code	Surge Current (kA)	Enclosure	Options
A = 120/240 V, 1Ø, 3W	60 = 600 kA per phase	0 = Standard NEMA	2 = Type 2 SPD (Default) Includes UL 1283 EMI/RFI Filters
B = 120/240 V, 3Ø, 4W	90 = 900 kA per phase	1/12/3R/4 Steel	0 = Type 1 SD (Consult Factory Prior to Ordering)
C = 120/208 V, 3Ø, 4W		V = NEMA 4X non-metallic	T = Thru-door disconnect
E = 277/480 V, 3Ø, 4W		S = NEMA 4X stainless steel	X = Surge Counter (Standard)
K = 380/220 V, 3Ø, 4W		F = NEMA 1 flush mount	
S = 400/230 V, 3Ø, 4W		P = NEMA 1 screwcover pullbox with extended display on 5ft cable for line side mounting in SWBD/SWGR	

Example: **TPS3CL15600X02** = 10 Mode, Type 2 SPD (Default) for a 208/120V application with a surge current capacity of 600 kA per phase, in a standard NEMA 1/12/3R/4 enclosure with a surge counter.

When an option is NOT selected, include a zero (0) in the field.

Available Accessories: Ordered Separately

RMSIE = Remote monitor
 ④ Other NEMA ratings may increase enclosure size and weight.

10 SPD

Frequently Asked Questions

What is a surge protective device or SPD?

A Surge Protective Device is a device that attenuates (reduces in magnitude) random, high energy, short duration overvoltages caused by lightning, utilities, switching, etc. Such anomalies occur in the form of voltage and current spikes with a duration of less than half an ac voltage cycle. These high energy power spikes can damage sensitive electronic equipment, such as computers, instrumentation, and process controllers.

How do SPDs work?

Surge Suppressors divert high energy power away from a load by providing a lower impedance path to common point earth ground. This is similar in concept to pressure relief valves that protect water heaters from overpressure. Surge suppressors used most often for protection of AC Power have metal oxide varistors (MOVs) connected in parallel.

Where are SPDs installed?

AC voltage surge suppressors are typically installed in these three areas: at a utility service entrance for protection of an entire facility, in distribution panelboards and switchboards for protection of sensitive downstream loads; connected to a wall outlet for individual protection of a specific piece of equipment, such as a computer or solid-state controller.

What is clamping voltage?

Clamping voltage, also referred to as peak let through or suppressed voltage rating, is the amount of voltage a surge suppressor permits to pass through it to the attached load during a transient event. Clamping voltage is a performance measurement of a surge suppressor's ability to attenuate a transient. For example, a surge suppressor might limit a 6,000V surge so that only 700V is 'visible' to the load. The Voltage Protection Rating is 700V, commonly called Clamping Voltage. This performance value is confirmed by Underwriters Laboratories during tests conducted while evaluating a surge suppressor for listing.

What is surge current capacity?

Surge current capacity is the maximum amount of surge current that a surge suppressor can pass for a single transient event. This level is used to indicate the protection capacity of a particular surge suppressor design, and when specifying surge suppressors. For example, in a high exposure application with very large transients present from lightning, a higher level surge current capacity might be desired. Be aware that surges have natural limitations and that larger surge current capacity tends to add redundancy rather than the implied ability to handle an extremely large surge. For

example, an entire lightning strike cannot go through wire; it is much like trying to put the output from a fire hose through a soda straw. Consequently, suppressors do not need to be sized for entire lightning strikes. There are valid reasons for adding excess surge current capacity for redundancy reasons.

What types of components make up a SPD?

The device most commonly used in AC voltage surge suppressors are MOVs, a solid-state device made of zinc oxide materials. MOVs are voltage sensitive semiconductors, which change from high impedance to low impedance when sensing an overvoltage condition. MOVs are packaged for specific voltages and current handling capacities. Other devices (more typically found in DC applications) include single junction diodes and gas tubes that ionize at preset voltages.

What features should be considered when selecting SPDs?

Two important areas to consider during the selection of a surge suppressor are performance and safety, and include the following criteria: Performance: 1) surge current capacity; and 2) clamping voltage. Safety: 1) the individual suppression circuit should be fused to clear an inoperative MOV during an extreme transient event, and 2) provide overcurrent protection for the surge suppressor during a fault condition.

What surge current capacity is required?

Surge current capacity is dependent on the application and the amount of required protection. The selection of the proper surge suppressor is not an exact science and cannot be scientifically calculated from a standard algorithm.

Questions to consider when specifying the proper surge current capacity for a surge suppressor include:

- What is the geographic location of the facility and it's susceptibility to lightning? (For example, Florida is a high-lightning area; California is a low lightning area.)
- Is the facility in a rural or urban setting?
- Is the facility the tallest building around?
- Is the facility at the end of the utility grid?
- If it is an existing facility, what is its power quality history?

Based on the above information, and taking into account the cost of protection, the following is a good rule of thumb: a surge suppressor with a surge current capacity in the range of 100kA to 300kA would be used in conjunction with a service entrance panelboard or switchboard. A surge suppressor with a surge current capacity in the range of 100kA to 200kA would be used in conjunction with a downstream panelboard