



**Power Mod
Meter Stack**



Uni-PAK Meter Center

Power Mod is built upon service, quality, and flexibility

Siemens Power Mod is a robust, flexible, and feature-rich line of modular metering designed to exceed today's market demands. Power Mod's exclusive QuickSystem has been proven to reduce labor by as much as 43% over comparable solutions while exclusive products such as the BFT Main Feed Thru family of mains, allow for lower material cost and incredible flexibility.

Uni-PAK Metering offers maximum flexibility and ease of installation

Siemens Uni-PAK Metering offers maximum flexibility and ease of installation to meet the service requirements of multiple position metering projects. The outdoor/indoor devices are available in two through six gang set-ups which consist of a pull section with main lugs or stud terminations, and 4/5 jaw meter sockets with tenant circuit breaker provisions.

contents

Power Mod Modular Metering

Overview of Power Mod Families	3-2 – 3-101
Configuration Tips and Applications	3-2 to 3-10
WB - Standard and Skinny Circuit Breaker Mains	3-11 to 3-13
WEB - Circuit Breaker Pullbox Combinations	3-14 to 3-19
WXB - Cross Bus Mains	3-20 to 3-23
WBT - Feed Thru Tap Box with Breaker	3-24 to 3-26
BFT - Main Feed Thru	3-27 to 3-29
WS - Standard Switch Mains	3-30 to 3-32
WES - Switch Pullbox Combinations	3-33 to 3-35
WXS - Cross Bus Switch Mains	3-36 to 3-38
WTB - Standard Tap boxes	3-39 to 3-41
WET - Tap box Pullbox Combinations	3-42 to 3-45
WT - Feed-Thru Tap boxes	3-46 to 3-48
WMM - Residential Meter Stacks	3-49 to 3-51
WML - Lever Bypass Meter Stacks	3-52 to 3-57
WMLZ - Fusible Residential Lever Bypass Meter Stacks	3-58 to 3-67
WMT - Test Block Bypass Meter Stacks	3-68 to 3-72
WMK - K-Base Meter Stacks	3-73 to 3-75
WC, WCL, WCT - House Power Modules	3-76 to 3-78
WSPD - Surge Protection Units	3-79 to 3-88
WMN ConEd Residential Meter Stacks	3-89 to 3-91
WTBN ConEd Tap boxes	3-92 to 3-94
WMMB - Aux Pull Box	3-96 to 3-98
Elbows and Spacers	3-99 to 3-100
	3-101

Uni-PAK Meter Centers

Introduction	3-102 – 3-124
WP Ring Style Meter Centers	3-102 – 3-104
WP Ringless Style Meter Centers — No Bypass	3-105
WP Ringless Style Meter Centers — Horn Bypass	3-106
WEP EUSERC Ringstyle	3-107
WPL Ringless, Lever Bypass	3-108
Knockout Diagrams	3-109
	3-110 – 3-124

Accessories and Replacement Parts

3-125 – 3-137

Scan to connect online to the most up-to-date version of this Section of SPEEDFAX.



Power Mod

Introduction to QuickSystem™ Features

Contractor-focused features, robust quality, dependable service, and exclusive products define Siemens Power Mod. The new standard in multi family metering. QuickSystem showcases the key strengths of Power Mod through five labor saving features:



QuickConnect™

A Siemens exclusive feature, QuickConnect reduces bussing connections from many to one – ensuring a single reliable connection instead of multiple connections.

Siemens
exclusive
feature

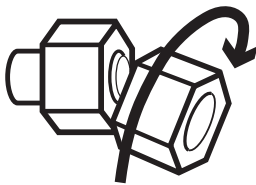

QuickTorque™

QuickTorque eliminates the need for time consuming torque readings. This breakaway nut provides a visual indicator of torque for the QuickConnect. When tightened, the outer head twists off at the proper torque for connection, leaving a single nut for future maintenance.

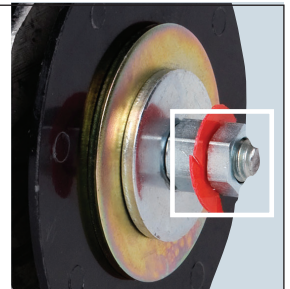

QuickBolt™

A Siemens exclusive feature, QuickBolt eliminates the requirement to line up mechanical connections – instead bolts remain retracted until the openings line up – allowing the bolts to protrude through automatically. Springs push the bolts through and provide positive pressure to keep bolts in place while wingnuts are attached and tightened.

Siemens
exclusive
feature

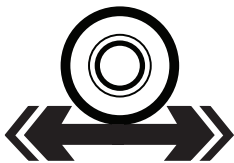

QuickRoll™

A Siemens exclusive feature, QuickRoll eliminates typical metal brackets for mounting modules on the wall. Instead of metal scraping metal, QuickRoll allows the module to glide down the mounting rail via a durable nylon wheel inside a mounting bracket.

Siemens
exclusive
feature

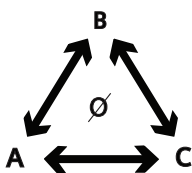

QuickPhase™

Each individual meter position can be phased independently according to the users needs. QuickPhase allows the user the ultimate flexibility to adjust to each individual application. Some exclusions apply.

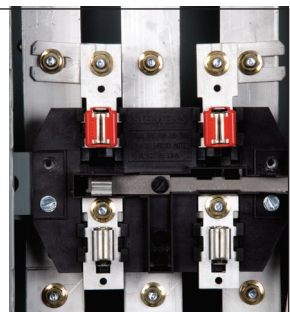

Power Mod

Introduction to Basic Features

Siemens Modular Metering includes an assortment of module types that can be configured to meet a wide range of residential and commercial ganging metering applications.

Siemens modular metering provides for single phase, three wire, 120/240V AC; three phase, four wire 120/208Y applications, and three phase in/out, 240 Volt max delta systems. The cross bus that connects devices is aluminum and has a 1200 Amp continuous current rating.

A typical application requires a main device module and one or more residential or commercial meter stacks. Depending on the application additional modules such as a pullbox, tap box, or a spacer may be required.

All of the enclosures are made with G90 galvanized steel and painted with ANSI 61 paint. All swing latches and rivets are made with stainless steel.



QuickConnect™

The time-saving QuickConnect™ (QC) provides a single connection for phase, neutral, and ground – all tightened by a single torque-indicating nut. Factory installed QuickBolt™ spring loaded bolts are located just above and below the QC opening to compress the surrounding gaskets together to form a water-tight seal. For extra stability additional nuts and bolts above and below QuickBolts are included as a means of physically joining the meter stacks together both above and below the QC opening.

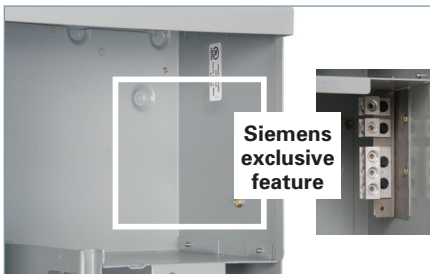

Neutral and Ground Provisions

All grounds and neutrals may be relocated toward the top or bottom of the enclosure depending on where the cables exit.



Tenant Breaker Provisions

Each 225 Amp meter socket has a provision for a 2-pole 225A max plug-in type QS circuit breaker. The compact QS breaker fits in two inches and reduces enclosure size limited total mounting space required. Single right hand bend wiring saves time and wire. Insert a 125A QP into a 225 Amp QS slot without conversion kits or filler plates. Generous gutter space allows for wires to exit the top, bottom, or back of the meter module.

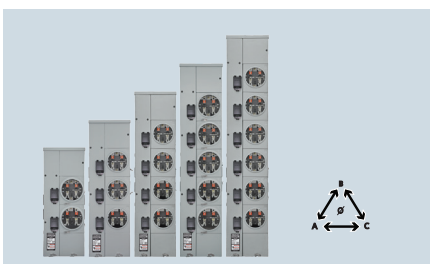







WMM Module factory phasing is as follows:

- 2 Gang: AB, BC
- 3 Gang: AB, BC, AC
- 4 Gang: AB, BC, AC, AB
- 5 Gang: AB, BC, AC, AB, BC
- 6 Gang: AB, BC, AC, AB, BC, AC

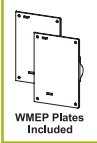
Any position can be adjusted to any phase in the field.

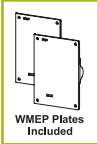



Power Mod

Overview of Families

	<p>WB – Standard Circuit Breaker Mains</p> <p>Standard breaker modules (type WB) offer a balance between functionality, feature, and size constraints.</p> <p>Features include:</p> <ul style="list-style-type: none"> ■ Compression lug landing pads (field install up to 1200 Amps, standard feature up to 2000 Amps) ■ Combination overhead and underground feed up to 1200 Amps, dedicated overhead or under ground feed up to 2000 Amps ■ 750kcmil AL wire options ■ 65K AIC standard, 100K AIC available for all models ■ Removable blank bottom endwall ■ Externally accessible breaker handle with padlock capability ■ Broad ampacity ratings up to 2000 Amps with non-standard amperages available (such as 700, 900, etc.) ■ Field installable shunt trips ■ DAS blue light models available in amperages of 1200-1600A 	<p>Standard Circuit Breaker Mains quick reference</p> <ul style="list-style-type: none"> ■ 200-2000A module rating ■ 1200A horizontal bus rating ■ UL Standard # 67 ■ UL file # E27100 ■ AIC rating (65k and 100k) ■ Voltage: <ul style="list-style-type: none"> – Single phase 120/240V AC max – Three phase 240V AC max ■ NEMA 3R rated 
	<p>WEB – Circuit Breaker-Pullbox Combinations</p> <p>EUSERC - compliant breaker - pullbox combination modules (type WEB) offer EUSERC compatibility, a wider range of lug options, and extra space for pulling in conductors.</p> <p>Features include:</p> <ul style="list-style-type: none"> ■ NEMA 2-stud lug mounting pattern ■ 750 kcmil AL wire options ■ 65K AIC standard, 100K AIC available for all models ■ Removable blank bottom endwall ■ Externally accessible breaker handle with padlock capability ■ Field installable shunt trips ■ Large removable ground wire trough with generous space for grounding conductors ■ DAS blue light models available in 1200A 	<p>Circuit Breaker-Pullbox Combo quick reference</p> <ul style="list-style-type: none"> ■ 200-1200A module rating ■ 1200A horizontal bus rating ■ UL standard # 67 ■ UL file # E27100 ■ AIC rating (65k and 100k) ■ Voltage <ul style="list-style-type: none"> – Single phase 120/240V AC Max – Three phase 240V AC Max ■ NEMA 3R rated ■ EUSERC drawing number 347 
	<p>WXB – Cross Bus Main</p> <p>The WXB family of main breaker devices features incoming and out-going horizontal bus connections (no incoming lugs). This patented design allows the user to utilize the WXB family to connect to Siemens Sentron Busway or connect to a tap box (or other main) to lower the overall ampacity of the service disconnect. In addition users can now utilize incoming tap boxes to split the service between multiple mains. This can save the end-user on the material cost of the meter bank. Please see the applications pages for more information.</p> <p>Features include:</p> <ul style="list-style-type: none"> ■ Incoming and Outgoing Power Mod horizontal bus ■ 65K AIC standard, 100K AIC available for all models ■ Broad ampacity ratings up to 1200 amps with non-standard amperages available (such as 700, 900, etc...) ■ Field installable shunt trip ■ DAS blue light models available in 1200A 	<p>Cross Bus Mains quick reference</p> <ul style="list-style-type: none"> ■ 400-1200A module rating ■ 1200A horizontal bus rating ■ UL Standard #67 ■ UL file # E27100 ■ AIC rating (65k and 100k) ■ Voltage: <ul style="list-style-type: none"> – Single phase 120/240V AC max – Three Phase 240V AC max ■ NEMA 3R (outdoor)  

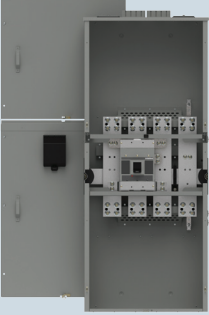
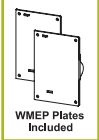
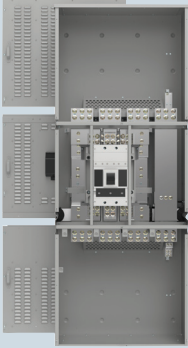
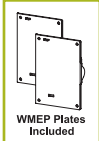
Power Mod

Overview of Families

	<p>WBT - Feed Thru Tap Box with Horizontal Bus Breaker</p> <p>Feed thru tap box and breaker module (type WBT) offers the ability to pull conductors in and out of the enclosure for rise cable or loop feed applications as well as a main breaker device utilizing an incoming and out-going thru bus connections (including incoming lugs). This patented design allows the user to utilize the WBT family to connect to Siemens Sentron Busway.</p> <p>Features include:</p> <ul style="list-style-type: none"> ■ Incoming and Outgoing Power Mod thru bus ■ Standard compression lug capability ■ 65K AIC standard, 100K AIC available for all models ■ Broad ampacity ratings up to 1200 Amps ■ DAS blue light models available in 1200A 	<p>Feed Thru Tap Box with Breaker quick reference</p> <ul style="list-style-type: none"> ■ 200-1200A breaker rating ■ 1200-2400A feed-thru rating ■ 1200A horizontal bus rating ■ UL Standard #67 ■ UL file #E27100 ■ AIC rating (65K and 100K) ■ Voltage: <ul style="list-style-type: none"> – Three Phase 240V AC max ■ NEMA 3R rated 
<p>⚠ Restrictions for WBT Feed Thru breaker tapbox units: ⚠</p>		
<p>Type WBT feed thru breaker tap boxes cannot be used as service equipment. The feed thru conductors must have upstream circuit protection. For feed thru conductor ratings up to 2,000 amps, Siemens Sentron or VL circuit breakers can be used. For feed thru conductor ratings over 2,000 amps but up to 2,400 amps, use Class L fuses. Please note that Siemens type WL circuit breakers CANNOT be used as the direct upstream main for these WBT feed thru breaker tap boxes.</p>		
	<p>BFT - Main Feed Thru</p> <p>Main feed thru (type BFT) breaker modules has the ability to isolate power to side-mounted modules just like any other Power Mod main breaker module, but also contains feed-through lugs that can be used to supply and isolate power vertically to downstream group metering line ups.</p> <p>Features include:</p> <ul style="list-style-type: none"> ■ Incoming and Outgoing Power Mod thru bus ■ Standard compression lug capability ■ 65K AIC standard, 100K AIC available for all models ■ Main breaker with broad ampacity ratings from 1200A to 2000A ■ DAS blue light models available in amperages of 1400-1600A ■ For 1200A DAS you must use a 1400A DAS module and have the trip setting dialed down to 1200A in the field. 	<p>Main Feed Thru quick reference</p> <ul style="list-style-type: none"> ■ 1200-2000A module rating (breaker) ■ 1200-2000A feed-thru rating ■ 1200A horizontal bus rating ■ UL Standard #67, file #E27100 ■ AIC rating (65K & 100K) ■ Voltage: 240V AC max ■ Available in single and three phase ■ NEMA 1 (Indoor) ■ Bottom feed only ■ All units come with no hubs ■ EUSERC drawing number 347 (EUSERC applies to 1200A unit only) 
	<p>WS - Standard Switch Mains</p> <p>Standard switch modules (type WS) are designed for flexibility, space savings, and durability.</p> <p>Features include:</p> <ul style="list-style-type: none"> ■ Standard compression lug capability ■ Invertibility: 400-800 Amp devices can be rotated to accommodate the desired incoming feed direction ■ 750 kcmil AL wire options for most models ■ 100K AIC standard for all models ■ Class T fuse provisions ■ Broad ampacity ratings up to 1200 Amps 	<p>Standard Switch Mains quick reference</p> <ul style="list-style-type: none"> ■ 200-1200A module rating ■ 1200A horizontal bus rating ■ 1200A thru-bus rating ■ UL Standard # 98 ■ UL file #E25506 ■ AIC rating (100k AIC) ■ Voltage: <ul style="list-style-type: none"> – Single phase 120/240V AC max – Three phase 240V AC max ■ NEMA 3R rated 
	<p>WES - Switch-Pullbox Combinations</p> <p>EUSERC - compliant switch-pullbox combination modules (type WES) offer EUSERC compatibility, a wider range of lug options, and extra space for pulling in conductors.</p> <p>Features include:</p> <ul style="list-style-type: none"> ■ NEMA 2-stud lug mounting pattern ■ Broad ampacity ratings up to 1200 Amps ■ 750kcmil AL wire options ■ 100K AIC standard for all models ■ Removable blank bottom endwall ■ Class T fuse provisions ■ Extra ground lugs in each device 	<p>Switch-Pullbox Combo quick reference</p> <ul style="list-style-type: none"> ■ 400-1200A module rating ■ 1200A horizontal bus rating ■ UL standard # 98 ■ UL file # E25506 ■ AIC Rating (100k AIC) ■ Voltage: <ul style="list-style-type: none"> – Single phase 120/240V AC max – Three phase 240V AC max ■ NEMA 3R rated ■ EUSERC drawing numbers 315, 343, and 347 

Power Mod

Overview of Families

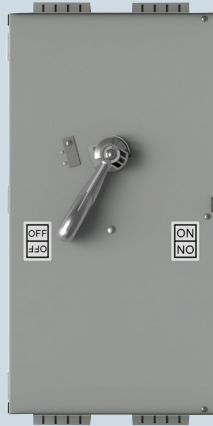

WXS – Cross Bus Switch

The WXS family of switches offers a standardized means of connecting Siemens Sentron busway to Power Mod for mid and high-rise applications. The Sentron Busway is connected via the TapStack which converts Sentron busway connections over to Power Mod horizontal bus connections. This enables the user to connect to Power Mod in as little as 9” of wall space.

Features include:

- Fast connection of end-feed busway to Power Mod meter banks
- Class T fuse provisions
- 100K AIC standard for all models

Pull Box quick reference

- 400-800A module rating
- 1200A horizontal bus rating
- UL Standard #98
- UL file # E25506
- AIC rating: 100K
- Voltage
 - Single phase 120/240V AC max
 - Three Phase 240V AC max
- NEMA 3R rated



WTB – Standard Tap boxes

Standard tap box modules (type WTB) are designed for versatility, space savings, and flexibility.

Features include:

- Standard compression lug capability
- Invertibility: devices can be rotated to accommodate the desired incoming feed direction
- 750 kcmil AL wire options for most models
- 100K AIC standard for all models
- Broad ampacity ratings from 400 to 2400 Amps
- Line and load capability- service entrance and sub-feed rated

Standard Tap box quick reference

- 400-2400A module rating
- 1200A horizontal bus rating
- UL Standard # 67
- UL file # E27100
- AIC rating (100K AIC)
- Voltage
 - Single phase 120/240V AC max
 - Three phase 240V AC max
- All swing latches and rivets are stainless steel.
- NEMA 3R rated

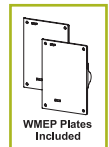

⚠ Restrictions for 1600-2400amp type WTB Power Mod Tap Boxes: ⚠

When the 1600, 2000, or 2400amp tap boxes are used as service entrance equipment (fed directly from utility transformer) or when the supply originates from a Class L fuse or Siemens WL circuit breaker there are restrictions on the use of an additional down-stream horizontal cross-bus connected WTB, WTB, WET, or WT type Power Mod tap boxes. When another tap box is connected to the same meter-bank, a type "WXB" module must be used as protection for the down-stream tap box (placed between the incoming WTB tap box and the downstream outgoing tap box). This restriction does NOT apply if the tap box is fed from a Siemens Sentron or VL series molded case circuit breaker. Note that the maximum amperage for a Siemens Sentron circuit breaker is 2,000amps.



WET – Tap box - Pullbox Combinations

EUSERC - compliant Tap box-Pullbox Combination modules (type WET) offer EUSERC compatibility, a wider range of lug options, and extra space for pulling in conductors.

Features include:

- Standard compression lug capability
- 750 kcmil AL wire options for most models
- 100K AIC standard for all models
- Broad ampacity ratings from 400 to 1200 Amps
- Removable bottom endwall



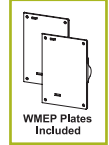

Tap box – Pullbox Combination quick reference

- 400-1200A module rating
- 1200A horizontal bus rating
- UL Standard #'s 67
- UL file # E27100
- AIC Rating (100k)
- Voltage
 - Single phase 120/240V AC max
 - Three phase 240V AC max
- All swing latches and rivets are stainless steel.
- NEMA 3R rated
- EUSERC drawing numbers 343, 343A, 347 (Pullbox)

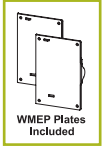

Power Mod

Overview of Families

	<p>WT – Feed Thru Tap box Feed-thru tap boxes (type WT) offer the ability to pull conductors in and out of the enclosure for riser cable or loop feed applications.</p> <p>Features include:</p> <ul style="list-style-type: none"> ■ Standard compression lug capability ■ 750kcmil Al wire options ■ 100k AIC standard ■ Removable bottom endwall ■ Broad ampacity ratings from 400 to 2400 Amps 	<p>Feed Thru Tap box quick reference</p> <ul style="list-style-type: none"> ■ 400-2400A module rating ■ 400-2400A feed-thru rating ■ 1200A horizontal bus rating ■ UL Standard #67 ■ UL file no. E27100 ■ AIC rating (100k AIC) ■ Voltage <ul style="list-style-type: none"> - Single phase 120/240V AC max - Three phase 240V AC max ■ NEMA 3R rated 
<p>⚠ Restrictions for 1600-2400amp type WT Power Mod Pull-Thru Tap Boxes: ⚠</p>		
<p>Type WT feed thru tap boxes cannot be used as service equipment. The feed thru conductors must have upstream circuit protection. When fed by a Class L fuse, there are restrictions on the use of additional downstream horizontal cross-bus connected WTBN, WET, or WT type Power Mod tap boxes. When another tap box is connected to the same meter-bank, a type WXB module must be used as protection for the downstream tap box (placed between the incoming WT tap box and the downstream outgoing tap box). This restriction does NOT apply if the tap box is fed from a Siemens Sentron or VL series molded case circuit breaker. Note that the maximum amperage for a Siemens Sentron circuit breaker is 2,000A. Please note that Siemens type WL circuit breakers CANNOT be used to feed WT Power Mod tap boxes.</p>		
	<p>WMM – Residential Meter Stacks The residential meter stacks (type WMM) are designed for residential applications. This core product offers many variations to meet the customers' requirements.</p> <p>Features include:</p> <ul style="list-style-type: none"> ■ Movable neutrals and grounds. ■ Pivoting rain gutter. ■ Removable back plate. ■ Center punch dimples (outdoor). ■ QP breakers used in 125A. ■ 225A versions can use QS or QP breakers. 	<p>Residential Meter Stacks quick reference</p> <ul style="list-style-type: none"> ■ 2-6 gang ■ 125/225 Amp per position ■ 1200 Amp horizontal-bus rating ■ UL Standard #67 and #414 ■ UL file no. E27100 ■ AIC rating (100k) ■ Voltage: <ul style="list-style-type: none"> - Single phase 120/240V AC max. - Three phase in single phase out <ul style="list-style-type: none"> ● 120/208V AC max. ● 240/120V AC max. ■ Outdoor= NEMA 3R rated ■ Indoor= NEMA 1 rated ■ Ring type units comply with EUSERC drawing number 353 
	<p>WML – Lever Bypass Meter Stacks Commercial Lever Bypass meter stacks (type WML) are designed to meet the requirements of those utilities specifying lever bypass meter sockets for residential and commercial applications.</p> <p>Features include:</p> <ul style="list-style-type: none"> ■ High-quality, time-proven Talon HQ sockets ■ A line of 3-phase 100 Amp meter stacks to minimize tenant main cost ■ Removable back knockout plate to facilitate wiring ■ 225 Amp capability in single and three phase designs ■ Up to 4 positions with 225 Amp tenant mains, up to 2 positions with 400 Amp tenant mains ■ Ease of wiring – tenant mains require only a single bend 	<p>Lever Bypass quick reference</p> <ul style="list-style-type: none"> ■ 100A/225A 1-4 position ■ 400A 1-2 position ■ 1200A horizontal-bus rating ■ UL Standard # UL67 ■ UL file # E27100 ■ AIC rating (25K, 65K and 100K) ■ Voltage <ul style="list-style-type: none"> - Single phase 120/240V AC max - Three in single phase out 208Y/120V AC - Three Phase 240V AC max ■ All swing latches and rivets are stainless steel. ■ Outdoor = NEMA 3R rated ■ Indoor = NEMA 1 rated 

Power Mod

Overview of Families



WML - Fusible Switch Lever Bypass Meter stacks

This Commercial Lever Bypass meter stacks (type WML) feature a 400 Amp - class T - fusible pull out assembly.

Features include:

- High-quality, time proven Talon HQ sockets
- Removable back knockout plate to facilitate wiring
- Available in single and three phases designs
- Single position with 400 Amp tenant main
- Ease of wiring

Lever Bypass With Fusible Switch Quick Reference:

- 400A 1 position
- 1200A horizontal bus rating
- UL Standard #UL67
- UL file #E27100
- AIC rating 65KAIC
- Voltage:
 - Single phase 120/240V AC max
 - Three phase in, single phase out 208Y/120V AC
 - Three Phase 240V AC max
- Outdoor= NEMA 3R rated
- Indoor= NEMA 1 rated



WMLZ/ WMLZF – Fusible Residential Lever Bypass Meter Stacks

The WMLZ and WMLZF lever bypass meter stacks are designed to allow the use of class T (400 Amp max) fuses ahead of all meter positions where the local serving utility may require it. WMLZF stacks feature a 400 Amp fusible pull out assembly which connects to a secondary 400 Amp horizontal bus that can feed downstream meter stacks. The WMLZ stacks include the secondary horizontal bus that can connect from the WMLZF meter stacks. The standard Power Mod 1200amp horizontal bus "passes thru" to feed downstream modules – the meter sockets in WMLZ and WMLZF do NOT connect directly to the 1200 Amp horizontal bus – only to the 400 Amp horizontal bus.

Features include:

- High-quality, time proven Talon HQ sockets
- 125 Amp capability for 3-phase in/ single-phase out
- 3 to 6 positions in both the fused stack and the expansion stack
- 400 Amp class T fusible-pullout in WMLZF stacks
- Secondary 400 Amp thru bus to supply power to downstream sockets
- Ease of wiring – tenant mains require only a single bend
- Preconfigures and wired.

Xcel Residential Lever Bypass Quick Reference:

- 125A 3-6 position
- 1200A horizontal bus rating
- 400A secondary horizontal-bus rating and vertical bus rating
- UL Standard #UL67
- UL file #E27100
- AIC rating (100K)
- Voltage
 - Three phase in, single phase out 208Y/120V AC
- Outdoor = NEMA 3R rated
- Indoor = NEMA 1 rated

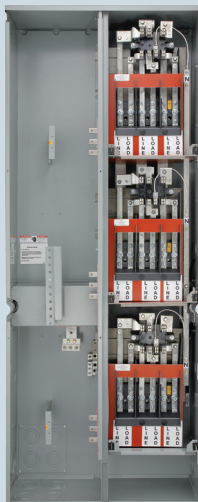

WMT – Test Block Bypass Meter Stacks

Commercial Test Block Bypass Meter Stacks (type WMT) are designed to meet the requirements of those utilities specifying test block bypass meter sockets for commercial applications in areas subscribing to the EUSERC standards.

Features include:

- High-quality, time-proven Siemens SMM switchboard meter socket
- Removable back knockout plate to facilitate wiring
- 225 Amp capability in single and three phase designs
- Up to 3 positions with 225 Amp tenant mains
- Wiring flexibility - tenant mains require only a single bend
- Three phase input, single phase output modules
- In line wiring: side knockouts allow wiring for adjacent units to pass through





Test Block Bypass quick reference

- 225A 1-3 positions
- 1200A horizontal bus rating
- UL Standard #'s 67
- UL file # E27100
- AIC Rating (100k)
- Voltage
 - Single phase 120/240V AC max
 - 3 phase in single phase out 120Y/208V AC max
 - Three phase 240V AC max
- Outdoor= NEMA 3R rated
- Indoor= NEMA 1 rated
- EUSERC drawing numbers 312 and 353

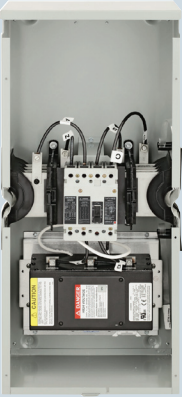

Power Mod

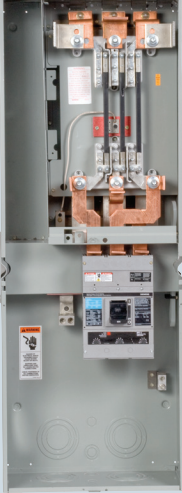
Overview of Families

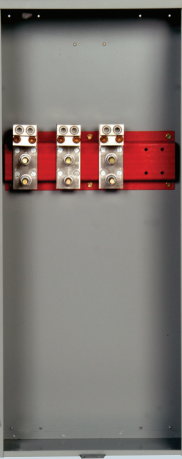
	<p>WSPD – Integral surge protection device for multi-family applications</p> <p>Surge protection modules for Power Mod (type WSPD) are horizontal-bus connected modules that allow the user to view surge status as well as access the SPD control panel without breaking the utility seal on the enclosure. An optional breaker disconnect is available to enable the end user to replace the SPD (surge protection device) without having to disconnect utility power to the Power Mod installation.</p> <p>Features include:</p> <ul style="list-style-type: none"> ■ 100,200,300,400,500kA ratings available ■ External, vandal resistant and lockable clear cover over SPD control panel ■ Single phase horizontal bus and three phase horizontal bus ■ Optional breaker disconnect that opens phase and neutral to make SPD replacement quick and easy 	<p>Surge Module quick reference</p> <ul style="list-style-type: none"> ■ 100-500kA ratings available ■ 1200A horizontal bus rating ■ UL Standard #67 ■ UL file # E27100 ■ AIC rating: 100K ■ Voltage <ul style="list-style-type: none"> – Single phase 120/240V AC max – Three Phase 240V AC max ■ NEMA 3R rated 
	<p>WMK – K-Base Meter Stacks</p> <p>Commercial K-Base Meter Stacks (type WMK) are designed to meet the requirements of those utilities specifying bolt-in meter sockets for 400 and 600 Amp residential and commercial applications.</p> <p>Features include:</p> <ul style="list-style-type: none"> ■ Exclusive Talon K4, K5, and K7 meter sockets ■ 1 position K4, K5, K7 modules with 400 and 600 Amp tenant mains ■ 2 position K7 module with 400 Amp tenant main ■ Space saving design 	<p>K-Base quick reference</p> <ul style="list-style-type: none"> ■ 400A and 600A 1-2 positions ■ 1200A horizontal bus rating ■ UL Standard # 67 ■ UL file # E27100 ■ AIC Rating (25k) ■ Voltage <ul style="list-style-type: none"> – Single Phase 120/240V AC Max – Three In Single Phase Out 208Y/120V AC – Three Phase 240V AC Max ■ NEMA 3R rated 
	<p>WMMB – auxiliary pull boxes for use with WB, WTB, and WS Power Mod modules</p> <p>Auxiliary pull boxes are used in cases where WEB, WES, or WET modules were not or cannot be used, but the user still needs to comply with the EUSERC standard. These modules feature incoming NEMA 2-stud lug mounting pattern lugs for underground feed and allow the user to pull wire from the lug landing in the pull box thru a 6" knockout and into: 400-1200amp WB, WTB and 400-800amp WS modules. Note this family does NOT have horizontal bus, it's intended only for lug in/lug out applications.</p> <p>Features include:</p> <ul style="list-style-type: none"> ■ 6" side opening (right or left) with available gasket to help mitigate wire insulation damage ■ EUSERC compliant incoming pull section 	<p>Pull Box quick reference</p> <ul style="list-style-type: none"> ■ 400, 800,1200 Amp ■ UL Standard #67 ■ UL file # E27100 ■ AIC rating: 100K ■ Voltage <ul style="list-style-type: none"> – Single phase 120/240V AC max – Three Phase 240V AC max ■ NEMA 3R rated ■ No horizontal bus

Power Mod

Overview of Families

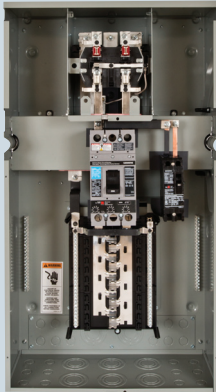

WC – Residential meter socket with load center distribution panel

The meter-load center combination offered by the WC series is unique and exclusive to the Siemens Power Mod family. This product offers the ability to combine house power applications with a meter socket thereby reducing material (pipe and wire) and installation time (separate load center or panel board).

Features include:

- Single phase horizontal bus and three phase horizontal bus
- 20 space - 40 circuit interior for single phase out put devices
- 24 space - 42 circuit interior for three phase out put devices
- Copper bus PL Series Siemens load center interior
- Dual neutral and ground provisions with Siemens patented Instawire technology
- Optional subfeed breaker for elevator applications
- 250 Amp overall device rating

WC House Power Panel quick reference:

- 250 Amp, 1 position
- 1200 Amp horizontal bus rating
- UL Standard #67
- UL Standard #414
- UL file # E27100
- AIC rating: 100K
- Voltage
 - Single phase 120/240V AC max
 - Three in single phase out 208Y120V AC
 - Three Phase 240V AC max
- NEMA 3R rated
- Copper load center bus bars
- 125Amp MAX subfeed breaker- factory installed (type HED4)
- 225Amp MAX main breaker- factory installed (type HFD6)

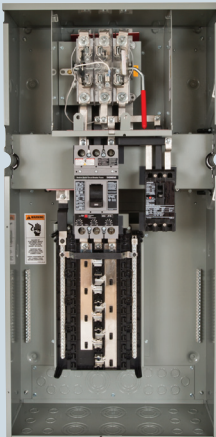

WCL – Commercial Lever Bypass meter socket with load center distribution panel

The meter-load center combination offered by the WCL series is unique and exclusive to the Siemens Power Mod family. This product offers the ability to combine house power applications with a meter socket thereby reducing material (pipe and wire) and installation time (separate load center or panel board). WCL modules feature the Talon HQ lever bypass for those utilities that specify lever bypass for residential and commercial applications.

Features include:

- Single phase horizontal bus and three phase horizontal bus
- 20 space - 40 circuit interior for single phase out put devices
- 24 space - 42 circuit interior for three phase out put devices
- Copper bus PL Series Siemens load center interior
- Dual neutral and ground provisions with Siemens patented Instawire technology
- Optional subfeed breaker for elevator applications
- 250 Amp overall device rating

WCL House Power Panel quick reference:

- 250 Amp, 1 position
- 1200A horizontal bus rating
- UL Standard #67
- UL Standard #414
- UL file # E27100
- AIC rating: 100K
- Voltage
 - Single phase 120/240V AC max
 - Three in single phase out 208Y120V AC
 - Three Phase 240V AC max
- NEMA 3R rated
- Copper load center bus bars
- 125Amp MAX subfeed breaker- factory installed (type HED4)
- 225Amp MAX main breaker- factory installed (type HFD6)



WCT – Commercial Test Block Bypass meter socket with load center distribution panel

The meter-load center combination offered by the WCT series is unique and exclusive to the Siemens Power Mod family. This product offers the ability to combine house power applications with a meter socket thereby reducing material (pipe and wire) and installation time (separate load center or panel board). WCT modules feature a test block bypass socket for utilities subscribing to the EUSERC standard.

Features include:

- Single phase horizontal bus and three phase horizontal bus
- 20 space - 40 circuit interior for single phase out put devices
- 24 space - 42 circuit interior for three phase out put devices
- Copper bus PL Series Siemens load center interior
- Dual neutral and ground provisions with Siemens patented Instawire technology
- Optional subfeed breaker for elevator applications
- 250amp overall device rating

WCT House Power Panel quick reference:

- 250 Amp, 1 position
- 1200 Amp horizontal bus rating
- UL Standard #67
- UL Standard #414
- UL file # E27100
- AIC rating: 100K
- Voltage
 - Single phase 120/240V AC max
 - Three in single phase out 208Y120V AC
 - Three Phase 240V AC max
- NEMA 3R rated
- Copper load center bus bars
- 125Amp MAX subfeed breaker- factory installed (type HED4)
- 225Amp MAX main breaker- factory installed (type HFD6)



Power Mod

Introduction

The breadth of the Power Mod product line is un-matched in the industry today. The available options result in many different ways to configure the same project with some solutions focusing on material cost and other solutions that create the opportunity for labor savings. The following pages contain examples and tips for using Power Mod in common multi-family metering applications including, but not limited to high rise buildings, mixed use, and garden style apartment complexes.

The following items are configuration tips and rules to keep in mind:

Ampacity and Bussing

Configurations are limited by the continuous current ratings for the main device (service entrance) and the horizontal bus. The Power Mod horizontal bus is always rated for 1200amps from the factory. Siemens does not offer low 800amp rated horizontal bus. All horizontal bus within the same meter bank must be single phase or three phase. Single and three phase horizontal bus cannot be mixed within the same meter bank.

Connections

A QuickConnect is required for each horizontal bus connection and is supplied with all WMM, WML, WMT, WC, WCL, WCT, WSPD, WMK, WXB, WXS, BE, WSP and WELB modules. The QuickConnect houses all phase, neutral, ground/bonding connections between Power Mod modules.

Utility Requirements

Utilities have varying requirements for equipment height, cover types, and bypass types. Therefore, utility acceptance should be verified prior to installation of any equipment. The COMPAS configuration tool can be utilized by any authorized Siemens sales or distributor representative to show critical dimensions of any installation.

Service Entrance Modules and Requirements

- In group metering applications breaker mains larger than 1200A have been used for years as center fed devices where the load out of either side is 1200A or lower. This practice is acceptable because the products are tested as a complete system in accordance with UL standards. When installed per these instructions, the panelboard will meet the UL listing of the product and will be consistent with proven industry standard practice.
- EUSERC-compliant service entrance modules (families WEB, WES, WET) are underground feed only and offer a wider range of lug options due to the larger enclosure size. These devices are also setup for compression lug installations from the factory.
- Tap boxes (families WTB, WT, WET) provide a direct connection to the horizontal bus and do not provide any overcurrent protection. A tap box can be used with the WXB and WXS cross bus main families. To provide overcurrent protection to downstream adjacent modules, WTB

and WET tap box families can be used as a service entrance point or a load side feed for remote equipment. WT feed-thru tap boxes cannot be used as service entrance devices. An additional QuickConnect must be ordered separately when using a tap box on the load side. The WTB family features invertibility on 400–1600amp models. Each item from this family includes two sets of QuickBolts. The eventual left side must be removed prior to installation.

- WB service entrance breaker modules: 200-1200amp modules are combination feed allowing service entrance conductors to enter the top or bottom of the enclosure. 1400-1600amp WB modules come in top or bottom feed (combination feed is not available). 2000amp WB modules are available in dedicated bottom feed or combination feed configurations.
- WS service entrance switch modules: 400 to 800amp modules are invertible for top or bottom feed. Each includes two sets of QuickBolts. The eventual left side must be removed prior to installation. 1200amp WS modules are bottom feed only and utilize a molded case switch (looks like a breaker) for the switching mechanism.

Spacing Requirements

A spacer is commonly required between a meter stack and a service entrance module. This is usually due to the need to have a minimum distance (left or right) from the meter to any obstruction. TIP: when the service entrance main is on the LEFT and you need a 125amp tenant main WMM stack use a 225amp WMM meter stack instead. The extra width of the 225amp stack will provide 10" of clearance from the main and, since you can use a standard Q2100 or Q2125 in the stack, the cost increase from 125 to 225amp is still less than adding a spacer (type WSP). This also saves the installation labor of the spacer.

Breaker Provisions

A tenant breaker must be ordered separately for each tenant position or configured as factory installed within the COMPAS configuration tool. Blank filler plates are not available thus un-used positions must have a breaker installed or the access cover must be locked.

Space Savings

Utilize the WC-WCL-WCT families to save space. These devices allow for consolidating the typical setup of a meter stack and separate panel into a single device if the application. This allows for less wall space, increased material savings, and a lower install cost. Please see the configurations on the following pages for examples.

Material Savings

Utilize the WXB cross bus mains to lower your overall material cost. When a large ampacity main is needed (1200amps or above) utilizing a tap box and a WXB main can lower the overall cost by eliminating costly large frame breakers from the installation. As shown in figures 3 and 4 the installation does require more wall space, but the overall dollars are lower.

Power Mod

Applications: Bus Duct Connections

Busway application

Siemens Power Mod offers an efficient and standardized means of connecting Sentron Busway to Power Mod utilizing the TapStack module. This module connects to a joint in the busway and converts the bus structure over to that of the Power Mod horizontal bus in only nine inches.

TapStacks are configured, priced, built, and shipped with the Sentron Busway. They require an additional QuickConnect coupler and are for indoor use on end-feed applications. TapStacks can connect to any Power Mod horizontal bus.

Options for the user are:

1. Direct Connection: in this option (below) the connection is made directly to any meter stack family. This application is for use when the service disconnect is located at the beginning of the busway.

2. Connection to a service disconnect: in this option a connection is made to either a WXB cross bus main or a WXS switch main. Please note that ANY other mains (WB, WEB, WS, WES) cannot act as a service disconnect for downstream meter stacks. The WB, WEB, WS, WES mains CAN be used as tenant mains on the load-side of a service disconnect for use in feeding large remote loads such as a CT cabinet. WXB mains are available up to 1200amps and WXS mains are available up to 800amps. Both families have 100K AIC options for all models.

3. Connection to a load-side main: In applications where branch circuit monitoring is used in lieu of Power Mod a tap stack plus Power Mod main (WB, WS) can be used where the installer cables out of the main over to a distribution panel (Siemens P3, P4, and P5 panel types). This essentially replaces a bus plug function.

For Center feed bus duct application please contact your Siemens representative.

Critical and recommended dimensions for Sentron Busway to Power Mod connections

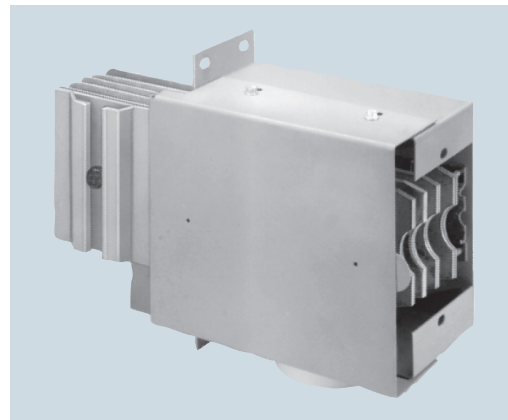
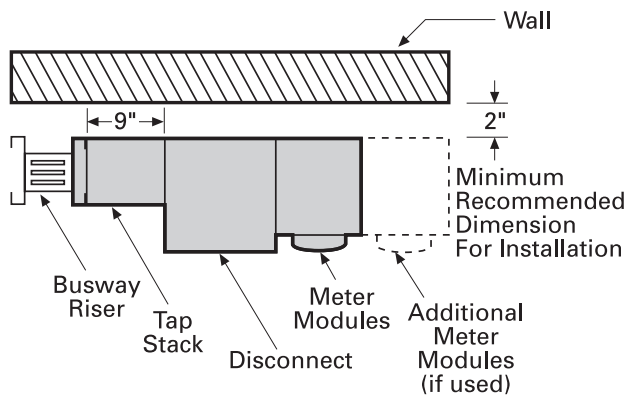

Tap Stack Module

Warning

Do not connect the Power Mod NEMA 1 corner units (BE) directly to busway; always use a WELB in its place or use another module as an intermediary between the two.

Power Mod

Applications: Bus Duct Solutions

Figure 11

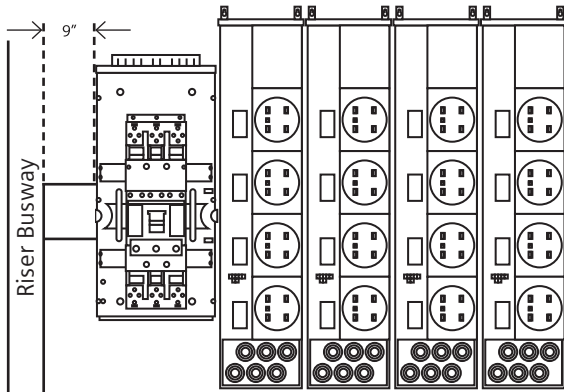

Example of WXB or WXS cross bus mains protecting stacks being fed by busway

Figure 12

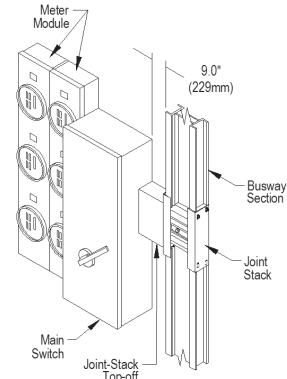
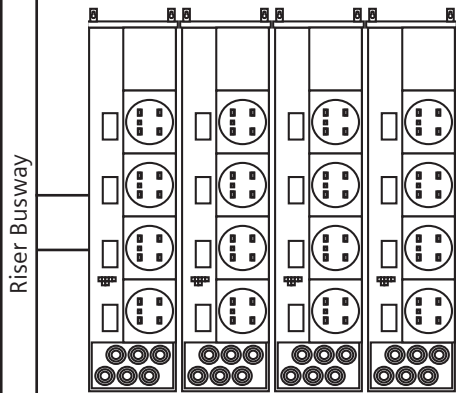
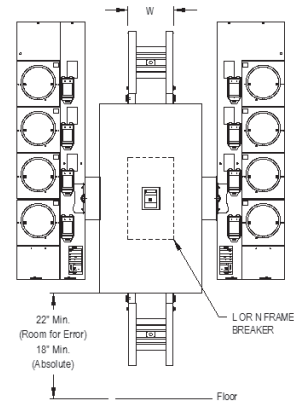

Figure 13



Example of stacks fed by busway tapstack with an upstream main

Figure 14



Example of stacks being fed by a meter center cubicle built inline with busway

Figure 15

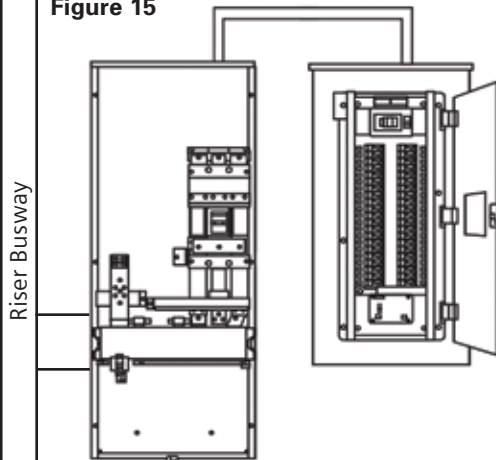

A WB main can be used to back-feed panel board off of busway

Please Note:

- There typically will be an offset off of the wall coming off of busway
- Strut or artificial walls can be used to mount power mod when fed by busway
- When fed by a cubicle tapstacks are not necessary
- Tapstacks are busway products and must be used when connecting Power Mod products to busway when a cubicle is not used
- Tapstacks and cubicles transpose busway phasing to match power mod phasing

Power Mod

Type WB Standard and Skinny Circuit Breaker Mains

Standard and Skinny Circuit Breaker Mains

Standard breaker modules (type WB) offer a balance between functionality, feature, and size constraints.

Features include:

- QuickSystem™ features
- Compression lug landing pads (field install up to 1200 Amps, standard feature up to 2000 Amps)
- Standard Mains offer combination overhead and underground feed up to 1200 Amps as well as dedicated overhead or underground feed up to 2000 Amps
- Skinny Mains offer dedicated feed options, overhead or underground, in modules 200-1200 Amps
- 750kcmil AL wire options
- 65K AIC standard, 100K AIC available for all models
- Removable blank bottom endwall
- Externally accessible breaker handle with padlock capability
- Broad ampacity ratings up to 2000 Amps with non-standard amperages available (such as 700, 900, etc.)
- Field installable shunt trips
- DAS blue light models available in amperages of 1200-1600

3
METER
CENTERS

Standard and Skinny Circuit Breaker Mains Quick Reference

- 200-2000A module rating
- 1200A horizontal bus rating
- UL Standard # UL67
- UL file # E27100
- AIC rating (65k and 100k)
- Voltage:
 - Single phase 120/240V AC max
 - Three phase 240V AC max
- All swing latches and rivets are stainless steel
- NEMA 3R rated
- G90 galvanized steel
- ANSI 61 paint

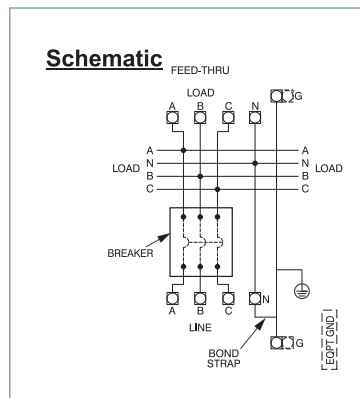
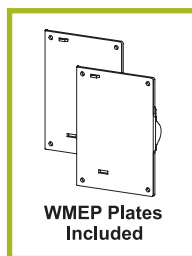

Power Mod

Type WB Standard Circuit Breaker Mains

Suitable for use as service equipment.
Bonding means may be removed for non-service entrance equipment applications.

Lugs are NOT included on 1400A-2000A standard breaker main modules and must be ordered separately.
Refer to pages 3-126-3-127 for lug size options.



Standard Mains - Single Phase

Thermal magnetic circuit breaker service entrance modules: 1-phase, 3-wire SN, 120/240V AC

Catalog number (65k AIC) ^③	Catalog number (100k AIC) ^{② ③}	Catalog No. (65k AIC) Blank Endwall	Catalog No. (100k AIC) Blank Endwall	Amp. rating	Service feed	Breaker type ^⑤	Dimensions (inches) ^①			Factory installed line side connections	Knockout Diagram
							Height	Width	Depth		
WB1200C ^②	WB1200CU	WB1200CNH	WB1200CUNH	200	OH/UG	JXD6	39.19	15.20	11.03	(2) 3/0-500 kcmil CU (2) 4/0-500 kcmil AL	KB-1
WB1250C ^②	WB1250CU	WB1250CNH	WB1250CUNH	250	OH/UG	JXD6	39.19	15.20	11.03	(2) 3/0-500 kcmil CU (2) 4/0-500 kcmil AL	
WB1300C ^②	WB1300CU	WB1300CNH	WB1300CUNH	300	OH/UG	JXD6	39.19	15.20	11.03	(2) 3/0-500 kcmil CU (2) 4/0-500 kcmil AL	
WB1350C ^②	WB1350CU	WB1350CNH	WB1350CUNH	350	OH/UG	JXD6	39.19	15.20	11.03	(2) 3/0-500 kcmil CU (2) 4/0-500 kcmil AL	
WB1400C	WB1400CU	WB1400CNH	WB1400CUNH	400	OH/UG	JXD6	39.19	15.20	11.03	(2) 3/0-500 kcmil CU (2) 4/0-500 kcmil AL	
WB1450C ^②	WB1450CU	WB1450CNH	WB1450CUNH	450	OH/UG	LXD6	39.19	15.20	11.03	(2) 3/0-500 kcmil CU (2) 4/0-500 kcmil AL	
WB1500C ^②	WB1500CU	WB1500CNH	WB1500CUNH	500	OH/UG	LXD6	39.19	15.20	11.03	(2) 3/0-500 kcmil CU (2) 4/0-500 kcmil AL	
WB1600C	WB1600CU	WB1600CNH	WB1600CUNH	600	OH/UG	LXD6	39.19	15.20	11.03	(2) 3/0-500 kcmil CU (2) 4/0-500 kcmil AL	
WB1700C ^②	WB1700CU	WB1700CNH	WB1700CUNH	700	OH/UG	MXD6	61.19	24.19	11.03	(3) 1/0-500 kcmil	KB-2
WB1800C	WB1800CU	WB1800CNH	WB1800CUNH	800	OH/UG	MXD6	61.19	24.19	11.03	(3) 1/0-500 kcmil	KB-3
WB1900C ^②	WB1900CU	WB1900CNH	WB1900CUNH	900	OH/UG	NXD6	61.19	24.19	11.03	(4) 1/0-500 kcmil	
WB11000C	WB11000CU	WB11000CNH	WB11000CUNH	1000	OH/UG	NXD6	61.19	24.19	11.03	(4) 1/0-500 kcmil	KB-4
WB11200C	WB11200CU	WB11200CNH	WB11200CUNH	1200	OH/UG	NXD6	61.19	24.19	11.03	(4) 1/0-500 kcmil	
WB11400T ^{②④}	WB11400TU ^④	WB11400TNH	WB11400TUNH	1400	OH	PXD6	72.06	31.34	14.66	3 Sets of 2 Studs  (lugs not included)	KB-4
WB11400B ^{②④}	WB11400BU ^④	—	—		UG	PXD6	72.06	31.34	14.66		KB-5
WB11600T ^④	WB11600TU ^④	WB11600TNH	WB11600TUNH	1600	OH	PXD6	72.06	31.34	14.66		KB-4
WB11600B ^④	WB11600BU ^④	—	—		UG	PXD6	72.06	31.34	14.66		KB-5
WB11800B ^{②④}	WB11800BU ^④	—	—	1800	UG	RXD6	72.06	31.34	14.66		KB-6
WB11800W	WB11800WU	WB11800WNH	WB11800WUNH		OH/UG	RXD6	72.06	50.56	14.66		KB-6
WB12000B ^④	WB12000BU ^④	—	—	2000	UG	RXD6	72.06	31.34	14.66	KB-5	
WB12000W ^{②④}	WB12000WU ^④	WB12000WNH	WB12000WUNH		OH/UG	RXD6	72.06	50.56	14.66	KB-6	

DAS electronic circuit breaker service entrance modules with blue light maintenance mode: 1-phase, 3 wire SN, 120/240V AC

Catalog number (65k AIC) ^③	Catalog number (100k AIC) ^{② ③}	Catalog No. (65k AIC) Blank Endwall	Catalog No. (100k AIC) Blank Endwall	Amp. rating	Service feed	Breaker type ^⑤	Dimensions (inches) ^①			Factory installed line side connections	Knockout Diagram
							Height	Width	Depth		
WBM11200C	WBM11200CU	WBM11200CNH	WBM11200CUNH	1200	OH/UG	SND6	61.19	24.19	11.03	(4) 1/0-500 kcmil	KB-3
WBM11400T	WBM11400TU	WBM11400TNH	WBM11400TUNH	1400	OH	SPD6	72.06	31.34	14.66	3 Sets of 2 Studs  (lugs not included)	KB-4
WBM11400B	WBM11400BU	—	—	1400	UG	SPD6	72.06	31.34	14.66		KB-5
WBM11600T	WBM11600TU	WBM11600TNH	WBM11600TUNH	1600	OH	SPD6	72.06	31.34	14.66		KB-4
WBM11600B	WBM11600BU	—	—	1600	UG	SPD6	72.06	31.34	14.66		KB-5

① Dimensions shown are representative of outside box dimensions and do not include allowances for mounting bumps, endwalls, covers, hubs, or hardware protrusions. Dimensions are subject to change.

② Additional lead time required. Contact sales office for details. 100K and non-standard amperage modules.

③ Factory installed lugs standard on 200-1200A standard breaker main modules. Additional lug kit options available for 750 conductor size. Field installable compression lug landing pad also available. NEMA 2-stud compression lugs must be installed by user or utility. Lugs NOT included on 1400A-2000A standard breaker main modules and must be ordered separately.

④ 1200 amp maximum feed per side-must be used as a center fed main.

⑤ All breakers have a non-interchangeable trip unit.

Power Mod

Type WB Standard Circuit Breaker Mains

Factory installed lugs are standard on 200-1200A standard breaker main modules. Additional lug kit options are available for 750 conductor size. Refer to pages 3-126 – 3-127 for lug kit options on 200-1200A standard main breakers. In addition, a field installable compression lug landing pad is also available. Refer to page 3-129 for lug landing pad options. NEMA 2-stud compression lugs must be installed by user or utility.

Suitable for use as service equipment. Bonding means may be removed for non-service entrance equipment applications.

Lugs are NOT included on 1400A-2000A standard breaker main modules and must be ordered separately.

Refer to pages 3-126–3-127 for lug size options.

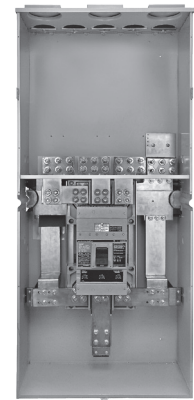

3
METER
CENTERS

Standard Mains – Three Phase

Thermal magnetic circuit breaker service entrance modules: 3-phase, 4-wire SN, 240V AC max

Catalog number (65k AIC) ^③	Catalog number (100k AIC) ^{② ③}	Catalog No. (65k AIC) Blank Endwall	Catalog No. (100k AIC) Blank Endwall	Amp. rating	Service feed	Breaker type ^⑤	Dimensions (inches) ^①			Factory installed line side connections	Knockout Diagram
							Height	Width	Depth		
WB3200C ^②	WB3200CU	WB3200CNH	WB3200CUNH	200	OH/UG	JXD6	39.19	15.20	11.03	(2) 3/0-500 kcmil CU (2) 1/0-500 kcmil AL	KB-1
WB3250C ^②	WB3250CU	WB3250CNH	WB3250CUNH	250	OH/UG	JXD6	39.19	15.20	11.03	(2) 3/0-500 kcmil CU (2) 1/0-500 kcmil AL	
WB3300C ^②	WB3300CU	WB3300CNH	WB3300CUNH	300	OH/UG	JXD6	39.19	15.20	11.03	(2) 3/0-500 kcmil CU (2) 1/0-500 kcmil AL	
WB3350C ^②	WB3350CU	WB3350CNH	WB3350CUNH	350	OH/UG	JXD6	39.19	15.20	11.03	(2) 3/0-500 kcmil CU (2) 1/0-500 kcmil AL	
WB3400C	WB3400CU	WB3400CNH	WB3400CUNH	400	OH/UG	JXD6	39.19	15.20	11.03	(2) 3/0-500 kcmil CU (2) 1/0-500 kcmil AL	
WB3450C ^②	WB3450CU	WB3450CNH	WB3450CUNH	450	OH/UG	LXD6	39.19	15.20	11.03	(2) 3/0-500 kcmil CU (2) 1/0-500 kcmil AL	
WB3500C ^②	WB3500CU	WB3500CNH	WB3500CUNH	500	OH/UG	LXD6	39.19	15.20	11.03	(2) 3/0-500 kcmil CU (2) 1/0-500 kcmil AL	
WB3600C	WB3600CU	WB3600CNH	WB3600CUNH	600	OH/UG	LXD6	39.19	15.20	11.03	(2) 3/0-500 kcmil CU (2) 1/0-500 kcmil AL	KB-2
WB3700C ^②	WB3700CU	WB3700CNH	WB3700CUNH	700	OH/UG	MXD6	61.19	24.19	11.03	(3) 1/0-500 kcmil	
WB3800C	WB3800CU	WB3800CNH	WB3800CUNH	800	OH/UG	MXD6	61.19	24.19	11.03	(3) 1/0-500 kcmil	KB-3
WB3900C ^②	WB3900CU	WB3900CNH	WB3900CUNH	900	OH/UG	NXD6	61.19	24.19	11.03	(4) 1/0-500 kcmil	
WB31000C	WB31000CU	WB31000CNH	WB31000CUNH	1000	OH/UG	NXD6	61.19	24.19	11.03	(4) 1/0-500 kcmil	KB-4
WB31200C	WB31200CU	WB31200CNH	WB31200CUNH	1200	OH/UG	NXD6	61.19	24.19	11.03	(4) 1/0-500 kcmil	
WB31400T ^{②④}	WB31400TU ^④	WB31400TNH	WB31400TUNH	1400	OH	PXD6	72.06	31.34	14.66	3 Sets of 2 Studs  (lugs not included)	KB-4
WB31400B ^{②④}	WB31400BU ^④	—	—		UG	PXD6	72.06	31.34	14.66		KB-5
WB31600T ^④	WB31600TU ^④	WB31600TNH	WB31600TUNH	1600	OH	PXD6	72.06	31.34	14.66		KB-4
WB31600B ^④	WB31600BU ^④	—	—		UG	PXD6	72.06	31.34	14.66		KB-5
WB31800B ^{②④}	WB31800BU ^④	—	—	1800	UG	RXD6	72.06	31.34	14.66		KB-6
WB31800W	WB31800WU	WB31800WNH	WB31800WUNH		OH/UG	RXD6	72.06	50.56	14.66		KB-5
WB32000B ^{③④}	WB32000BU ^④	—	—	2000	UG	RXD6	72.06	31.34	14.66	KB-5	
WB32000W ^{②④}	WB32000WU ^④	WB32000WNH	WB32000WUNH		OH/UG	RXD6	72.06	50.56	14.66	KB-6	

DAS electronic circuit breaker service entrance modules with blue light maintenance mode: 3-phase, 4 wire SN, 240V AC max

Catalog number (65k AIC) ^③	Catalog number (100k AIC) ^{② ③}	Catalog No. (65k AIC) Blank Endwall	Catalog No. (100k AIC) Blank Endwall	Amp. rating	Service feed	Breaker type ^⑤	Dimensions (inches) ^①			Factory installed line side connections	Knockout Diagram
							Height	Width	Depth		
WBM31200C	WBM31200CU	WBM31200CNH	WBM31200CUNH	1200	OH/UG	SND6	61.19	24.19	11.03	(4) 1/0-500 kcmil	KB-3
WBM31400T	WBM31400TU	WBM31400TNH	WBM31400TUNH	1400	OH	SPD6	72.06	31.34	14.66	3 Sets of 2 Studs  (lugs not included)	KB-4
WBM31400B	WBM31400BU	—	—	1400	UG	SPD6	72.06	31.34	14.66		KB-5
WBM31600T	WBM31600TU	WBM31600TNH	WBM31600TUNH	1600	OH	SPD6	72.06	31.34	14.66	KB-4	
WBM31600B	WBM31600BU	—	—	1600	UG	SPD6	72.06	31.34	14.66	KB-5	

① Dimensions shown are representative of outside box dimensions and do not include allowances for mounting bumps, endwalls, covers, hubs, or hardware protrusions. Dimensions are subject to change.

② Additional lead time required. Contact sales office for details. 100K and non-standard amperage modules.

③ Factory installed lugs standard on 200-1200A standard breaker main modules. Additional lug kit options available for 750 conductor size. Field installable compression lug landing pad also available. NEMA 2-stud compression lugs must be installed by user or utility. Lugs NOT included on 1400A-2000A standard breaker main modules and must be ordered separately.

④ 1200 amp maximum feed per side-must be used as a center fed main.

⑤ All breakers have a non-interchangeable trip unit.

Power Mod

Type WB Skinny Circuit Breaker Mains with Dedicated Feed Direction

Suitable for use as service equipment.
Bonding means may be removed for non-service entrance equipment applications.

Skinny Mains are narrower than standard WB mains because they require a predetermined dedicated feed direction; either top feed or bottom feed.

This direction must be known prior to selecting the unit. If feed direction is unknown, use a combination feed unit from previous pages.



Skinny Mains – Single Phase

Skinny thermal magnetic circuit breaker service entrance modules: 1-phase, 3-wire SN, 120/240V AC^③

Catalog number (65k AIC)	Catalog number (100k AIC) ^②	Catalog No. (65k AIC) Blank Endwall	Catalog No. (100k AIC) Blank Endwall ^②	Amp. rating	Service feed	Breaker type ^④	Dimensions (inches) ^①			Factory installed line side connections ^⑤
							Height	Width	Depth	
WB1200T	WB1200TU	WB1200TNH	WB1200TUNH	200	Top	JXD6	45.19	9.56	11	(2) 3/0-500 kcmil CU (2) 4/0-500 kcmil AL
WB1200B	WB1200BU	—	—	200	Bottom	JXD6	45.19	9.56	11	(2) 3/0-500 kcmil CU (2) 4/0-500 kcmil AL
WB1250T	WB1250TU	WB1250TNH	WB1250TUNH	250	Top	JXD6	45.19	9.56	11	(2) 3/0-500 kcmil CU (2) 4/0-500 kcmil AL
WB1250B	WB1250BU	—	—	250	Bottom	JXD6	45.19	9.56	11	(2) 3/0-500 kcmil CU (2) 4/0-500 kcmil AL
WB1300T	WB1300TU	WB1300TNH	WB1300TUNH	300	Top	JXD6	45.19	9.56	11	(2) 3/0-500 kcmil CU (2) 4/0-500 kcmil AL
WB1300B	WB1300BU	—	—	300	Bottom	JXD6	45.19	9.56	11	(2) 3/0-500 kcmil CU (2) 4/0-500 kcmil AL
WB1350T	WB1350TU	WB1350TNH	WB1350TUNH	350	Top	JXD6	45.19	9.56	11	(2) 3/0-500 kcmil CU (2) 4/0-500 kcmil AL
WB1350B	WB1350BU	—	—	350	Bottom	JXD6	45.19	9.56	11	(2) 3/0-500 kcmil CU (2) 4/0-500 kcmil AL
WB1400T	WB1400TU	WB1400TNH	WB1400TUNH	400	Top	JXD6	45.19	9.56	11	(2) 3/0-500 kcmil CU (2) 4/0-500 kcmil AL
WB1400B	WB1400BU	—	—	400	Bottom	JXD6	45.19	9.56	11	(2) 3/0-500 kcmil CU (2) 4/0-500 kcmil AL
WB1450T	WB1450TU	WB1450TNH	WB1450TUNH	450	Top	LXD6	45.19	9.56	11	(2) 3/0-500 kcmil CU (2) 4/0-500 kcmil AL
WB1450B	WB1450BU	—	—	450	Bottom	LXD6	45.19	9.56	11	(2) 3/0-500 kcmil CU (2) 4/0-500 kcmil AL
WB1500T	WB1500TU	WB1500TNH	WB1500TUNH	500	Top	LXD6	45.19	9.56	11	(2) 3/0-500 kcmil CU (2) 4/0-500 kcmil AL
WB1500B	WB1500BU	—	—	500	Bottom	LXD6	45.19	9.56	11	(2) 3/0-500 kcmil CU (2) 4/0-500 kcmil AL
WB1600T	WB1600TU	WB1600TNH	WB1600TUNH	600	Top	LXD6	45.19	9.56	11	(2) 3/0-500 kcmil CU (2) 4/0-500 kcmil AL
WB1600B	WB1600BU	—	—	600	Bottom	LXD6	45.19	9.56	11	(2) 3/0-500 kcmil CU (2) 4/0-500 kcmil AL
WB1700T	WB1700TU	WB1700TNH	WB1700TUNH	700	Top	MXD6	58.69	11.06	13.25	(3) 1/0-500 kcmil
WB1700B	WB1700BU	—	—	700	Bottom	MXD6	58.69	11.06	13.25	
WB1800T	WB1800TU	WB1800TNH	WB1800TUNH	800	Top	MXD6	58.69	11.06	13.25	
WB1800B	WB1800BU	—	—	800	Bottom	MXD6	58.69	11.06	13.25	(4) 1/0-500 kcmil
WB1900T	WB1900TU	WB1900TNH	WB1900TUNH	900	Top	NXD6	58.69	11.06	13.25	
WB1900B	WB1900BU	—	—	900	Bottom	NXD6	58.69	11.06	13.25	
WB11000T	WB11000TU	WB11000TNH	WB11000TUNH	1000	Top	NXD6	58.69	11.06	13.25	
WB11000B	WB11000BU	—	—	1000	Bottom	NXD6	58.69	11.06	13.25	
WB11200T	WB11200TU	WB11200TNH	WB11200TUNH	1200	Top	NXD6	58.69	11.06	13.25	(4) 1/0-500 kcmil
WB11200B	WB11200BU	—	—	1200	Bottom	NXD6	58.69	11.06	13.25	

Skinny DAS electronic circuit breaker service entrance modules with blue light: 1-phase, 3 wire SN, 120/240V AC^③

Catalog number (65k AIC)	Catalog number (100k AIC) ^②	Catalog No. (65k AIC) Blank Endwall	Catalog No. (100k AIC) Blank Endwall ^②	Amp. rating	Service feed	Breaker type ^④	Dimensions (inches) ^①			Factory installed line side connections ^⑤
							Height	Width	Depth	
WBM11200T	WBM11200TU	WBM11200TNH	WBM11200TUNH	1200	Top	SND6	58.69	11.06	13.25	(4) 1/0-500 kcmil
WBM11200B	WBM11200BU	—	—	1200	Top	SND6	58.69	11.06	13.25	(4) 1/0-500 kcmil



Caution: Feed direction is not changeable in the field. Only select a Skinny Main if feed direction is certain. If feed direction is not certain, use combination feed mains found on pages 3-15 – 3-16.



① Dimensions shown are representative of outside box dimensions and do not include allowances for mounting bumps, endwalls, covers, hubs, or hardware protrusions. Dimensions are subject to change.

② Additional lead time required. Contact sales office for details. 100K and non-standard amperage modules.

③ Factory installed lugs standard on 200-1200A standard breaker main modules. Additional lug kit options available for 750 conductor size.

④ All breakers have a non-interchangeable trip unit.

⑤ Skinny Mains are non-compatible with the lug landing pads LLP600 and LLP1200.

Power Mod

Type WB Skinny Circuit Breaker Mains with Dedicated Feed Direction

Suitable for use as service equipment.
Bonding means may be removed for non-service entrance equipment applications.

Skinny Mains are narrower than standard WB mains because they require a predetermined dedicated feed direction; either top feed or bottom feed.

This direction must be known prior to selecting the unit. If feed direction is unknown, use a combination feed unit from previous pages.



Skinny Mains – Three Phase

Skinny thermal magnetic circuit breaker service entrance modules: 3-phase, 4-wire SN, 240V AC max^③

Catalog number (65k AIC)	Catalog number (100k AIC) ^②	Catalog No. (65k AIC) Blank Endwall	Catalog No. (100k AIC) Blank Endwall ^②	Amp. rating	Service feed	Breaker type ^④	Dimensions (inches) ^①			Factory installed line side connections ^⑤
							Height	Width	Depth	
WB3200T	WB3200TU	WB3200TNH	WB3200TUNH	200	Top	JXD6	45.19	9.56	11	(2) 3/0-500 kcmil CU
WB3200B	WB3200BU	—	—	200	Bottom	JXD6	45.19	9.56	11	(2) 4/0-500 kcmil AL
WB3250T	WB3250TU	WB3250TNH	WB3250TUNH	250	Top	JXD6	45.19	9.56	11	(2) 3/0-500 kcmil CU
WB3250B	WB3250BU	—	—	250	Bottom	JXD6	45.19	9.56	11	(2) 4/0-500 kcmil AL
WB3300T	WB3300TU	WB3300TNH	WB3300TUNH	300	Top	JXD6	45.19	9.56	11	(2) 3/0-500 kcmil CU
WB3300B	WB3300BU	—	—	300	Bottom	JXD6	45.19	9.56	11	(2) 4/0-500 kcmil AL
WB3350T	WB3350TU	WB3350TNH	WB3350TUNH	350	Top	JXD6	45.19	9.56	11	(2) 3/0-500 kcmil CU
WB3350B	WB3350BU	—	—	350	Bottom	JXD6	45.19	9.56	11	(2) 4/0-500 kcmil AL
WB3400T	WB3400TU	WB3400TNH	WB3400TUNH	400	Top	JXD6	45.19	9.56	11	(2) 3/0-500 kcmil CU
WB3400B	WB3400BU	—	—	400	Bottom	JXD6	45.19	9.56	11	(2) 4/0-500 kcmil AL
WB3450T	WB3450TU	WB3450TNH	WB3450TUNH	450	Top	LXD6	45.19	9.56	11	(2) 3/0-500 kcmil CU
WB3450B	WB3450BU	—	—	450	Bottom	LXD6	45.19	9.56	11	(2) 4/0-500 kcmil AL
WB3500T	WB3500TU	WB3500TNH	WB3500TUNH	500	Top	LXD6	45.19	9.56	11	(2) 3/0-500 kcmil CU
WB3500B	WB3500BU	—	—	500	Bottom	LXD6	45.19	9.56	11	(2) 4/0-500 kcmil AL
WB3600T	WB3600TU	WB3600TNH	WB3600TUNH	600	Top	LXD6	45.19	9.56	11	(2) 3/0-500 kcmil CU
WB3600B	WB3600BU	—	—	600	Bottom	LXD6	45.19	9.56	11	(2) 4/0-500 kcmil AL
WB3700T	WB3700TU	WB3700TNH	WB3700TUNH	700	Top	MXD6	58.69	11.06	13.25	(3) 1/0-500 kcmil
WB3700B	WB3700BU	—	—	700	Bottom	MXD6	58.69	11.06	13.25	
WB3800T	WB3800TU	WB3800TNH	WB3800TUNH	800	Top	MXD6	58.69	11.06	13.25	
WB3800B	WB3800BU	—	—	800	Bottom	MXD6	58.69	11.06	13.25	(4) 1/0-500 kcmil
WB3900T	WB3900TU	WB3900TNH	WB3900TUNH	900	Top	NXD6	58.69	11.06	13.25	
WB3900B	WB3900BU	—	—	900	Bottom	NXD6	58.69	11.06	13.25	
WB31000T	WB31000TU	WB31000TNH	WB31000TUNH	1000	Top	NXD6	58.69	11.06	13.25	
WB31000B	WB31000BU	—	—	1000	Bottom	NXD6	58.69	11.06	13.25	(4) 1/0-500 kcmil
WB31200T	WB31200TU	WB31200TNH	WB31200TUNH	1200	Top	NXD6	58.69	11.06	13.25	
WB31200B	WB31200BU	—	—	1200	Bottom	NXD6	58.69	11.06	13.25	

Skinny DAS electronic circuit breaker service entrance modules with blue light: 3-phase, 4 wire SN, 240V AC max^③

Catalog number (65k AIC)	Catalog number (100k AIC) ^②	Catalog No. (65k AIC) Blank Endwall	Catalog No. (100k AIC) Blank Endwall ^②	Amp. rating	Service feed	Breaker type ^④	Dimensions (inches) ^①			Factory installed line side connections ^⑤
							Height	Width	Depth	
WBM31200T	WBM31200TU	WBM31200TNH	WBM31200TUNH	1200	Top	SND6	58.69	11.06	13.25	(4) 1/0-500 kcmil
WBM31200B	WBM31200BU	—	—	1200	Bottom	SND6	58.69	11.06	13.25	



Caution: Feed direction is not changeable in the field. Only select a Skinny Main if feed direction is certain. If feed direction is not certain, use combination feed mains found on pages 3-15 – 3-16.



① Dimensions shown are representative of outside box dimensions and do not include allowances for mounting bumps, endwalls, covers, hubs, or hardware protrusions. Dimensions are subject to change.

② Additional lead time required. Contact sales office for details. 100K and non-standard amperage modules.

③ Factory installed lugs standard on 200-1200A standard breaker main modules. Additional lug kit options available for 750 conductor size.

④ All breakers have a non-interchangeable trip unit.

⑤ Skinny Mains are non-compatible with the lug landing pads LLP600 and LLP1200.

Power Mod

Type WB Standard Circuit Breaker Mains Knockout Diagrams

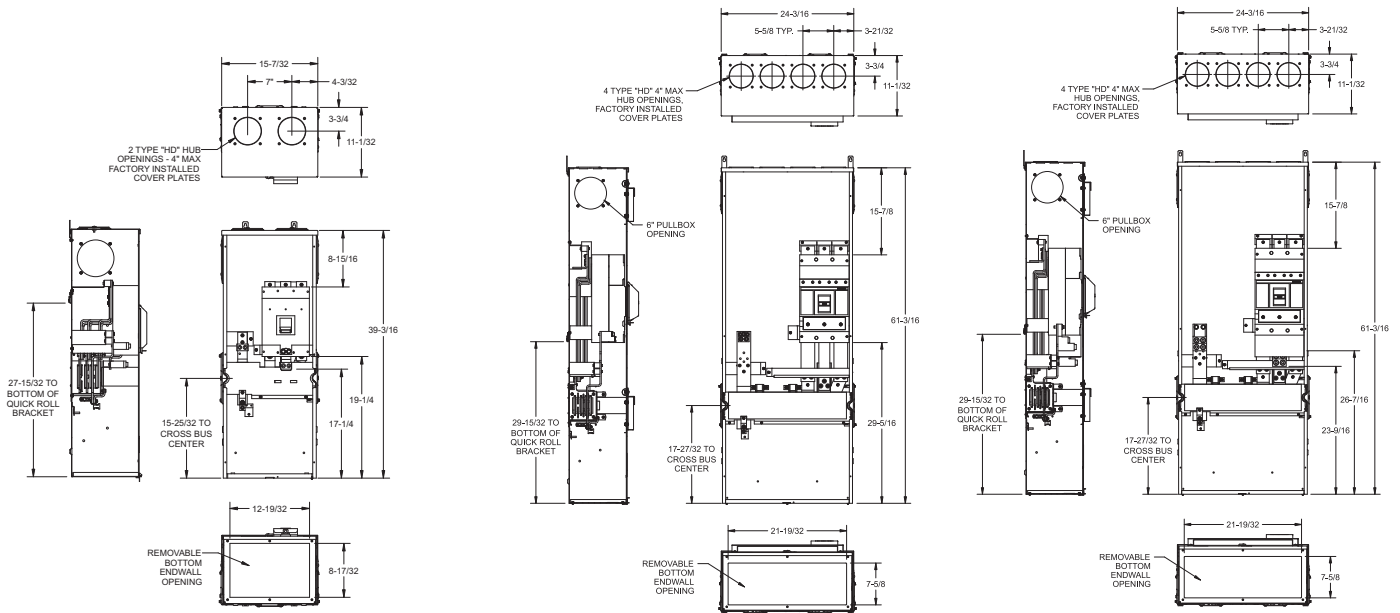

KB-1	
WB3200XX	WB1200XX
WB3250XX	WB1250XX
WB3300XX	WB1300XX
WB3350XX	WB1350XX
WB3400XX	WB1400XX
WB3450XX	WB1450XX
WB3500XX	WB1500XX
WB3600XX	WB1600XX

KB-2	
WB3700XX	WB1700XX
WB3800XX	WB1800XX

KB-3	
WB3900XX	WB1900XX
WB31000XX	WB11000XX
WB31200XX	WB11200XX

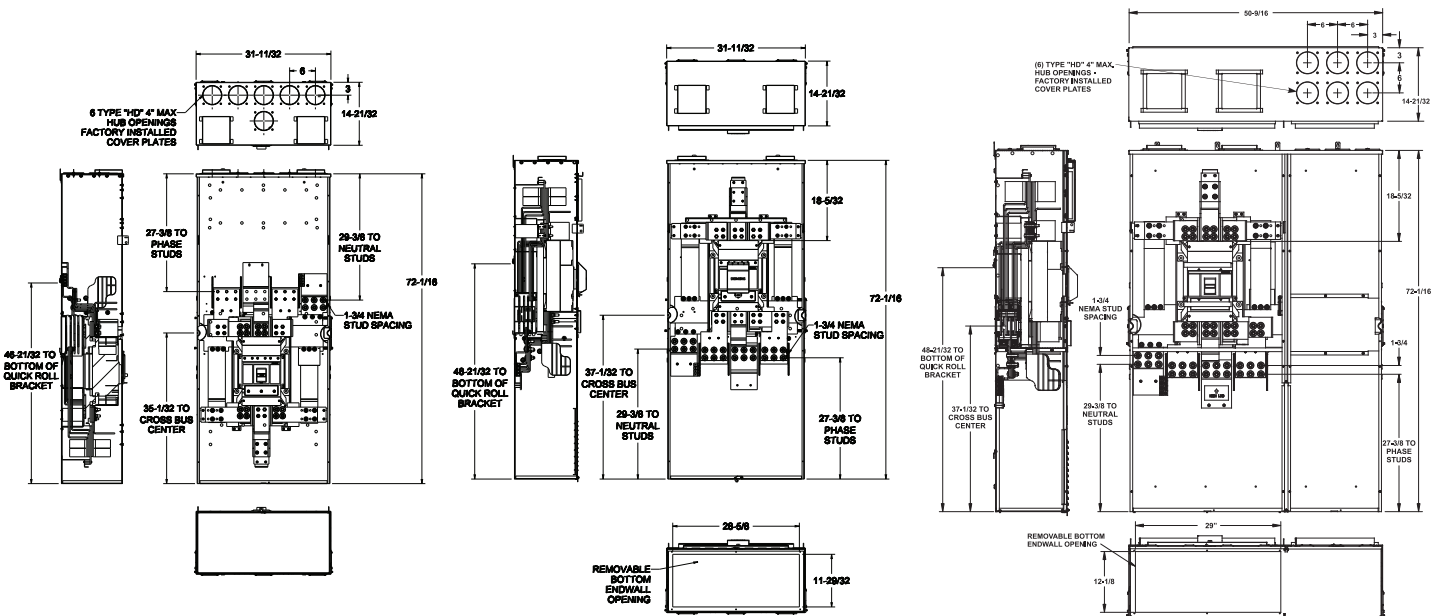

KB-4	
WB31400TX	WB11400TX
WB31600TX	WB11600TX
WB32000TX	WB12000TX

KB-5	
WB31400BX	WB11400BX
WB31600BX	WB11600BX
WB31800BX	WB11800BX
WB32000BX	WB12000BX

KB-6	
WB12000W	WB31800W
WB12000WU	WB31800WU
WB11800W	WB32000W
WB11800WU	WB32000WU

Power Mod

Type WEB Circuit Breaker – Pullbox Combinations

Circuit Breaker – Pullbox Combinations

EUSERC – compliant breaker – pullbox combination modules (type WEB) offer EUSERC compatibility, a wider range of lug options, and extra space for pulling in conductors.

Features include:

- QuickSystem™ features
- NEMA 2-stud lug mounting pattern
- 750 kcmil AL wire options
- 65K AIC standard, 100K AIC available for all models
- Removable blank bottom endwall
- Externally accessible breaker handle with padlock capability
- Field installable shunt trips
- Large removable ground wire trough with generous space for grounding conductors
- DAS blue light models available in 1200A

3
METER
CENTERS

Circuit Breaker-Pullbox Combinations Quick Reference

- 200-1200A module rating
- 1200A horizontal bus rating
- UL standard # UL67
- UL file # E27100
- AIC rating (65k and 100k)
- Voltage
 - Single phase 120/240V AC max
 - Three phase 240V AC max
- All swing latches and rivets are stainless steel
- NEMA 3R rated
- G90 galvanized steel
- ANSI 61 paint
- EUSERC drawing number 347

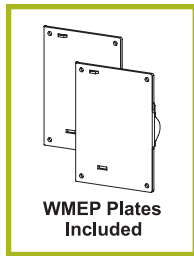

Schematics

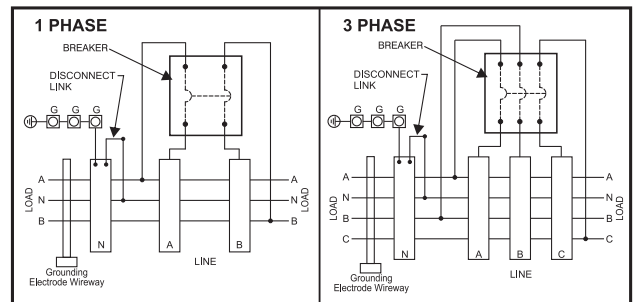

Power Mod

Type WEB Circuit Breaker – Pullbox Combinations



Suitable for use as service equipment.
Bonding means may be removed for non-service entrance equipment applications.

Lugs are NOT included and must be ordered separately.

Refer to pages 3-126–3-127 for lug size options.



Thermal magnetic combination circuit breaker and pullbox modules: 1-phase, 3-wire SN, 120/240V AC max, meets EUSERC requirements

Catalog number (65k AIC)	Catalog number (100k AIC) ^②	Ampere rating	Service feed	Breaker type ^④	Dimensions (inches) ^①			Line side ^③ connections (lugs not included)	Knockout Diagram
					Height	Width	Depth		
WEB1200B ^②	WEB1200BU	200	UG	JXD6	54.88	28.28	13.06	1 set of 2 studs 	EB-1
WEB1250B ^②	WEB1250BU	250	UG	JXD6	54.88	28.28	13.06		
WEB1300B ^②	WEB1300BU	300	UG	JXD6	54.88	28.28	13.06		
WEB1350B ^②	WEB1350BU	350	UG	JXD6	54.88	28.28	13.06		
WEB1400B	WEB1400BU	400	UG	JXD6	54.88	28.28	13.06		
WEB1500B ^②	WEB1500BU	500	UG	LXD6	54.88	28.88	13.06	2 sets of 2 studs 	EB-2
WEB1600B	WEB1600BU	600	UG	LXD6	54.88	28.28	13.06		
WEB1700B ^②	WEB1700BU	700	UG	MXD6	59.34	34.22	12.47	3 sets of 2 studs 	EB-3
WEB1800B	WEB1800BU	800	UG	MXD6	59.34	34.22	12.47		
WEB1900B ^②	WEB1900BU	900	UG	NXD6	59.34	34.22	12.47		
WEB11000B	WEB11000BU	1000	UG	NXD6	59.34	34.22	12.47		
WEB11200B	WEB11200BU	1200	UG	NXD6	59.34	34.22	12.47		

DAS electronic combination circuit breaker and pullbox modules with blue light maintenance mode: 1-phase, 3-wire SN, 120/240V AC max, meets EUSERC requirements

Catalog number (65k AIC)	Catalog number (100k AIC) ^②	Ampere rating	Service feed	Breaker type ^④	Dimensions (inches) ^①			Line side ^③ connections (lugs not included)	Knockout Diagram
					Height	Width	Depth		
WEBM11200B	WEBM11200BU	1200	UG	SND6	59.34	34.22	12.47	3 sets of 2 studs 	EB-3

① Dimensions shown are representative of outside box dimensions and do not include allowances for mounting bumps, endwalls, covers, hubs, or hardware protrusions. Dimensions are subject to change.

② Additional lead time required. Contact sales office for details. Non-standard modules

③ Lugs not included. Refer to page 3-126-3-127 for lug size options. 750 conductor size available. NEMA 2-stud compression lugs must be installed by user or utility.
④ All breakers have a non-interchangeable trip unit.

Power Mod

Type WEB Circuit Breaker - Pullbox Combinations



Suitable for use as service equipment.
Bonding means may be removed for non-service entrance equipment applications.

Lugs are NOT included and must be ordered separately.

Refer to pages 3-126–3-127 for lug size options.



Thermal magnetic combination circuit breaker and pullbox modules: 3-phase, 4-wire SN, 240V AC max, meets EUSERC requirements

Catalog number (65k AIC)	Catalog number (100k AIC) ^②	Ampere rating	Service feed	Breaker type ^④	Dimensions (inches) ^①			Line side ^③ connections (lugs not included)	Knockout Diagram
					Height	Width	Depth		
WEB3200B ^②	WEB3200BU	200	UG	JXD6	54.88	28.28	13.06	1 set of 2 studs 	EB-1
WEB3250B ^②	WEB3250BU	250	UG	JXD6	54.88	28.28	13.06		
WEB3300B ^②	WEB3300BU	300	UG	JXD6	54.88	28.28	13.06		
WEB3350B ^②	WEB3350BU	350	UG	JXD6	54.88	28.28	13.06		
WEB3400B	WEB3400BU	400	UG	JXD6	54.88	28.28	13.06		
WEB3500B ^②	WEB3500BU	500	UG	LXD6	54.88	28.28	13.06	2 sets of 2 studs 	EB-2
WEB3600B	WEB3600BU	600	UG	LXD6	54.88	28.28	13.06		
WEB3700B ^②	WEB3700BU	700	UG	MXD6	59.34	34.22	12.47	3 sets of 2 studs 	EB-3
WEB3800B	WEB3800BU	800	UG	MXD6	59.34	34.22	12.47		
WEB3900B ^②	WEB3900BU	900	UG	NXD6	59.34	34.22	12.47		
WEB31000B	WEB31000BU	1000	UG	NXD6	59.34	34.22	12.47		
WEB31200B	WEB31200BU	1200	UG	NXD6	59.34	34.22	12.47		

DAS electronic combination circuit breaker and pullbox modules with blue light maintenance mode: 3-phase, 4-wire SN, 240V AC max, meets EUSERC requirements

Catalog number (65k AIC)	Catalog number (100k AIC) ^②	Ampere rating	Service feed	Breaker type ^④	Dimensions (inches) ^①			Line side ^③ connections (lugs not included)	Knockout Diagram
					Height	Width	Depth		
WEBM31200B	WEBM31200BU	1200	UG	SND6	59.34	34.22	12.47	3 sets of 2 studs 	EB-3

① Dimensions shown are representative of outside box dimensions and do not include allowances for mounting bumps, endwalls, covers, hubs, or hardware protrusions. Dimensions are subject to change.

② Additional lead time required. Contact sales office for details. Non-standard modules

③ Lugs not included. Refer to page 3-126–3-127 for lug size options. 750 conductor size available. NEMA 2-stud compression lugs must be installed by user or utility.
④ All breakers have a non-interchangeable trip unit.

Power Mod

Type WEB Circuit Breaker – Pullbox Combinations: Knockout Diagrams

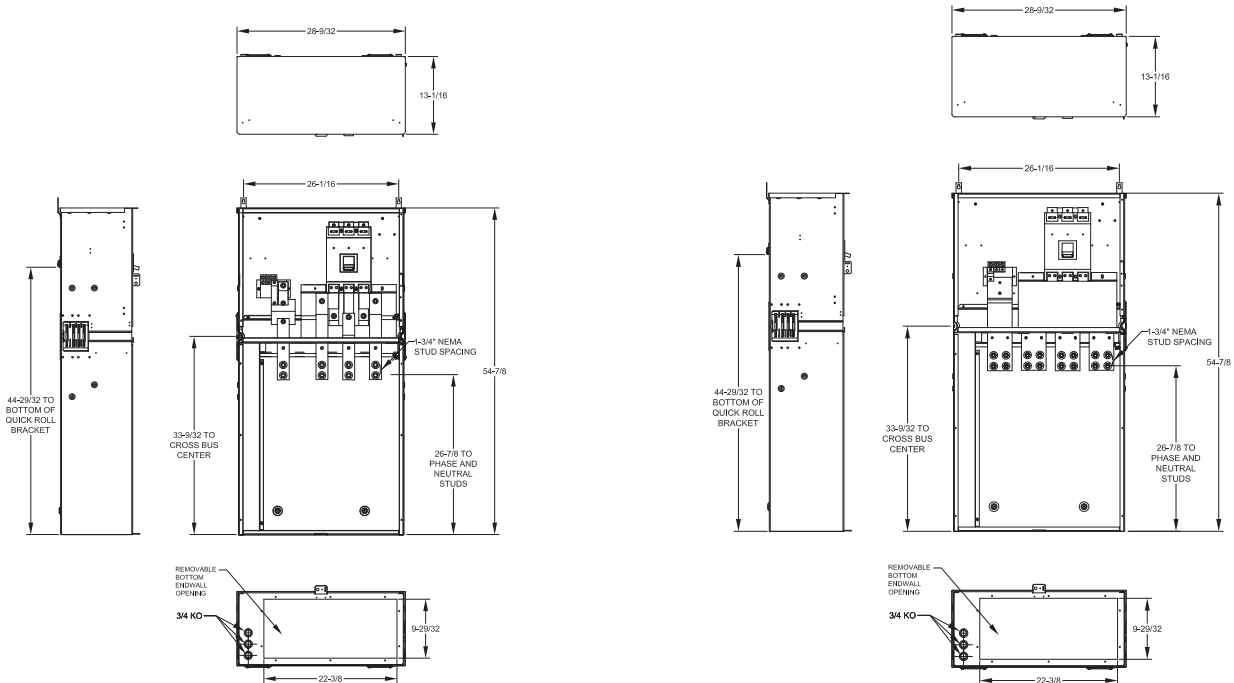

EB-1			
WEB1200B	WEB3300B	WEB1200BU	WEB3300BU
WEB3200B	WEB1350B	WEB3200BU	WEB1350BU
WEB1250B	WEB3350B	WEB1250BU	WEB3350BU
WEB3250B	WEB1400B	WEB3250BU	WEB1400BU
WEB1300B	WEB3400B	WEB1300BU	WEB3400BU

EB-2	
WEB1500B	WEB3500B
WEB1500BU	WEB3500BU
WEB1600B	WEB3600B
WEB1600BU	WEB3600BU

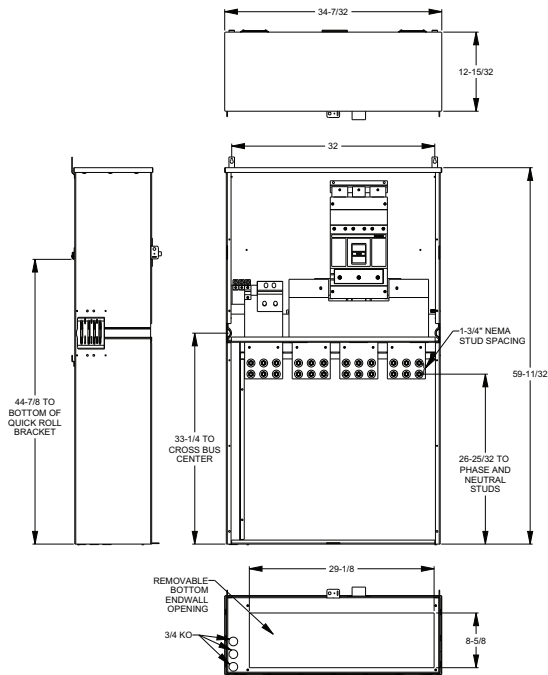

EB-3				
WEB1700B	WEB1700BU	WEB1900B	WEB11000B	WEB11000BU
WEB3700B	WEB3700BU	WEB1900BU	WEB11200B	WEB11200BU
WEB1800B	WEB1800BU	WEB3900B	WEB31000B	WEB31000BU
WEB3800B	WEB3800BU	WEB3900BU	WEB31200B	WEB31200BU

Power Mod

Type WXB Main Units

Cross Bus Main modules

Cross Bus Main modules (type WXB) offer two distinct functions: first they can be used to connect Siemens Sentron Busway to a Power Mod line-up. Second they can be utilized to offer lower service sdisconnect ampacities or unique configurations where an incoming tap box is preferred. See application pages for examples.

Features include:

- QuickSystem™ features
- Incoming and outgoing bus connections (right to left or left to right)
- Standardized connection points to Siemens Sentron Busway
- 65K AIC standard, 100K AIC available for all models
- Externally accessible breaker handle with padlock capability
- Broad ampacity ratings up to 1200 Amps with non-standard amperages available (such as 700, 900, etc.)
- Field installable shunt trips
- DAS blue light models available in 1200A"

Circuit Breaker-Pullbox Combinations Quick Reference

- 400-1200A module rating
- 1200A horizontal bus rating
- UL Standard # UL67
- UL file # E27100
- AIC rating (65k and 100k)
- Voltage:
 - Single phase 120/240V AC max
 - Three phase 240V AC max
- All swing latches and rivets are stainless steel
- NEMA 3R rated
- G90 galvanized steel
- ANSI 61 paint

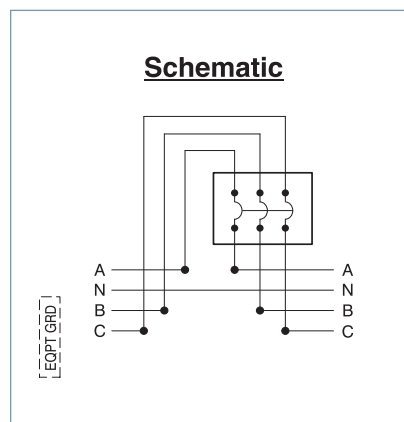

Power Mod

Type WXB Main Units

Not for use as service equipment.

Connects via
horizontal bussing
only - NO LUGS



Thermal magnetic circuit breaker modules: 1-phase, 3-wire SN, 120/240V AC^②

Catalog number (65k AIC)	Catalog number (100k AIC) ^③	Ampere rating	Service Feed	Breaker Type	Dimensions ^①			Knockout diagram
					Height	Width	Depth	
WXB1200N	WXB1200NU	200	Horizontal Bus	JXD6	27.05	15.59	10.82	WXB-1
WXB1250N	WXB1250NU	250	Horizontal Bus	JXD6	27.05	15.59	10.82	
WXB1300N	WXB1300NU	300	Horizontal Bus	JXD6	27.05	15.59	10.82	
WXB1350N	WXB1350NU	350	Horizontal Bus	JXD6	27.05	15.59	10.82	
WXB1400N	WXB1400NU	400	Horizontal Bus	JXD6	27.05	15.59	10.82	
WXB1450N	WXB1450NU	450	Horizontal Bus	LXD6	27.05	15.59	10.82	
WXB1500N	WXB1500NU	500	Horizontal Bus	LXD6	27.05	15.59	10.82	
WXB1600N	WXB1600NU	600	Horizontal Bus	LXD6	27.05	15.59	10.82	
WXB1700N	WXB1700NU	700	Horizontal Bus	MXD6	36.05	18.13	12.63	WXB-2
WXB1800N	WXB1800NU	800	Horizontal Bus	MXD6	36.05	18.13	12.63	
WXB1900N	WXB1900NU	900	Horizontal Bus	NXD6	36.05	18.13	12.63	WXB-3
WXB11000N	WXB11000NU	1000	Horizontal Bus	NXD6	36.05	18.13	12.63	
WXB11200N	WXB11200NU	1200	Horizontal Bus	NXD6	41.06	18.13	12.63	WXB-4

Thermal magnetic circuit breaker modules: 3-phase, 4-wire SN, 240V AC max^②

Catalog number (65k AIC)	Catalog Number (100k AIC) ^③	Ampere rating	Service Feed	Breaker Type	Dimensions ^①			Knockout diagram
					Height	Width	Depth	
WXB3200N	WXB3200NU	200	Horizontal Bus	JXD6	27.05	15.59	10.82	WXB-1
WXB3250N	WXB3250NU	250	Horizontal Bus	JXD6	27.05	15.59	10.82	
WXB3300N	WXB3300NU	300	Horizontal Bus	JXD6	27.05	15.59	10.82	
WXB3350N	WXB3350NU	350	Horizontal Bus	JXD6	27.05	15.59	10.82	
WXB3400N	WXB3400NU	400	Horizontal Bus	JXD6	27.05	15.59	10.82	
WXB3450N	WXB3450NU	450	Horizontal Bus	LXD6	27.05	15.59	10.82	
WXB3500N	WXB3500NU	500	Horizontal Bus	LXD6	27.05	15.59	10.82	
WXB3600N	WXB3600NU	600	Horizontal Bus	LXD6	27.05	15.59	10.82	
WXB3700N	WXB3700NU	700	Horizontal Bus	MXD6	36.05	18.13	12.63	WXB-2
WXB3800N	WXB3800NU	800	Horizontal Bus	MXD6	36.05	18.13	12.63	
WXB3900N	WXB3900NU	900	Horizontal Bus	NXD6	36.05	18.13	12.63	WXB-3
WXB31000N	WXB31000NU	1000	Horizontal Bus	NXD6	36.05	18.13	12.63	
WXB31200N	WXB31200NU	1200	Horizontal Bus	NXD6	41.06	18.13	12.63	WXB-4

DAS electronic circuit breaker modules with blue light maintenance mode: 1-phase, 3 wire SN, 120/240V AC^②

Catalog number (65k AIC)	Catalog number (100k AIC) ^①	Ampere rating	Service Feed	Breaker Type	Dimensions ^①			Knockout diagram
					Height	Width	Depth	
WXB11200N	WXB11200NU	1200	Horizontal bus	SND6	41.06	18.13	12.63	WXB-4

DAS electronic circuit breaker modules with blue light maintenance mode: 3-phase, 4 wire SN, 240V AC max^②

Catalog number (65k AIC)	Catalog number (100k AIC) ^①	Ampere rating	Service Feed	Breaker Type	Dimensions ^①			Knockout diagram
					Height	Width	Depth	
WXB31200N	WXB31200NU	1200	Horizontal bus	SND6	41.06	18.13	12.63	WXB-4

① Dimensions shown are representative of outside box dimensions and do not include allowances for mounting bumps, endwalls, covers, hubs, or hardware protrusions. Dimensions are subject to change.

② Connects via horizontal bussing only.

③ Non Standard item – extended lead time applies

Power Mod

Type WXB Main Units: Knockout Diagrams

3
METER
CENTERS

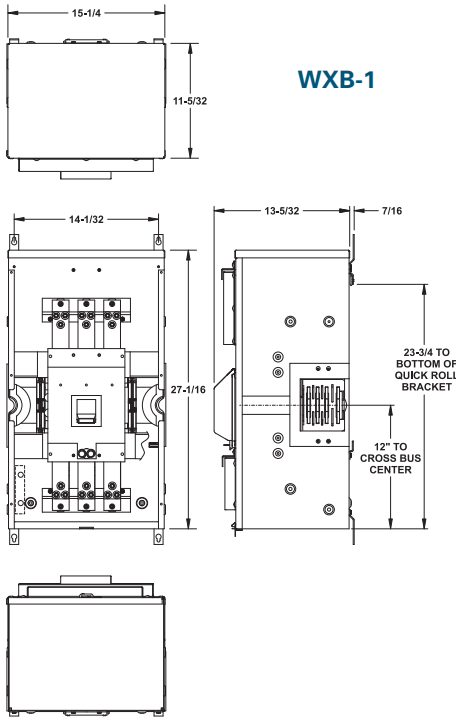

WXB-1

WXB-1	
WXB1200N	WXB3200N
WXB1200NU	WXB3200NU
WXB1250N	WXB3250N
WXB1250NU	WXB3250NU
WXB1300N	WXB3300N
WXB1300NU	WXB3300NU
WXB1350N	WXB3350N
WXB1350NU	WXB3350NU
WXB1400N	WXB3400N
WXB1400NU	WXB3400NU
WXB1450N	WXB3450N
WXB1450NU	WXB3450NU
WXB1500N	WXB3500N
WXB1500NU	WXB3500NU
WXB1600N	WXB3600N
WXB1600NU	WXB3600NU

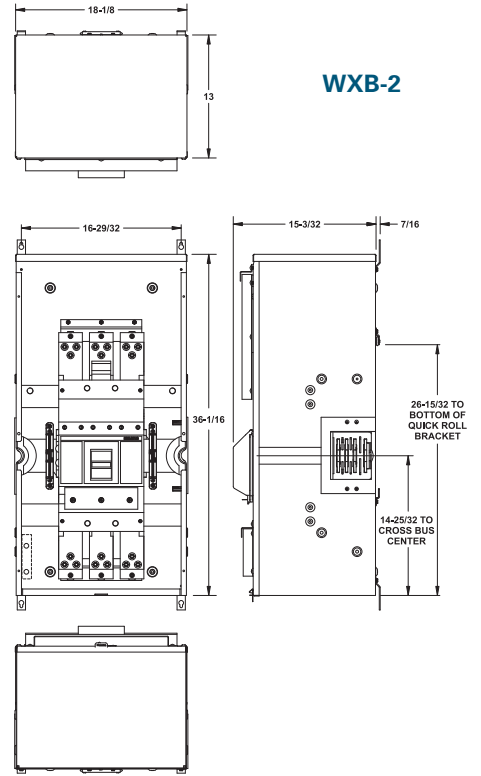

WXB-2

WXB-2	
WXB1700N	WXB3700N
WXB1700NU	WXB3700NU
WXB1800N	WXB3800N
WXB1800NU	WXB3800NU

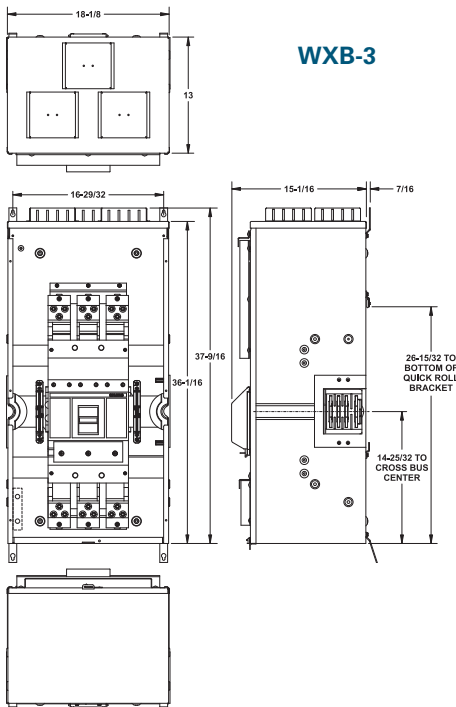

WXB-3

WXB-3	
WXB1900N	WXB3900N
WXB1900NU	WXB3900NU
WXB11000N	WXB31000N
WXB11000NU	WXB31000NU

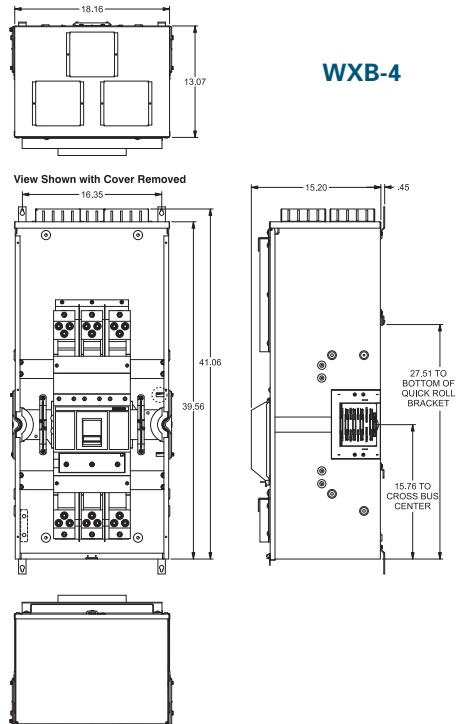

WXB-4

WXB-4	
WXB11200N	WXB31200N
WXB11200NU	WXB31200NU
WXB11200N	WXB31200N
WXB11200NU	WXB31200NU

Power Mod

Type WBT Feed Thru Tap Box with Horizontal Bus Breaker

WBT - Feed Thru Tap Box with Breaker

The feed thru tap box with breaker (type WBT) offers the ability to pull conductors in and out of the enclosure for rise cable or loop feed applications as well as a main breaker device utilizing an incoming and out-going thru bus connections (including incoming lugs). In addition users don't have to utilize any additional tap boxes as lugs are already included in the units. This can save the end-user on the material cost of the meter bank.

The breaker in the WBT module only protects the floor that it is on. The vertical feed-thru lugs bypass the breaker entirely; This is the main distinction between the WBT and the BFT. Do not get this unit confused with the BFT main feed thru, as described on pages 3-30 -3-32. The BFT protects the floor it is on as well as the vertical cable run leaving out of the top of the unit, whereas the WBT only protects the floor it is on.

The WBT cannot be used as a service entrance point therefore the neutral and ground are un-bonded. With that in mind, be sure to have an upstream protective device (BFT, WB, WEB, switchboard, etc.) ahead of the WBT module.

Features include:

- QuickSystem™ features
- Incoming and Outgoing Power Mod thru bus
- Standard compression lug capability
- 65K AIC standard, 100K AIC available for all models
- Broad ampacity ratings from 200-1200A
- Field installable shunt trip
- DAS blue light models available in 1200 Amps

Feed Thru Tap Box with Breaker Quick Reference

- 200-1200A breaker rating
- 1200-2400A feed-thru rating
- 1200A horizontal bus rating
- UL Standard #67
- UL file #E27100
- AIC rating (65K and 100K)
- Voltage:
 - Three Phase 240V AC max
- All swing latches and rivets are stainless steel
- NEMA 3R (outdoor)
- G90 galvanized steel
- ANSI 61 paint

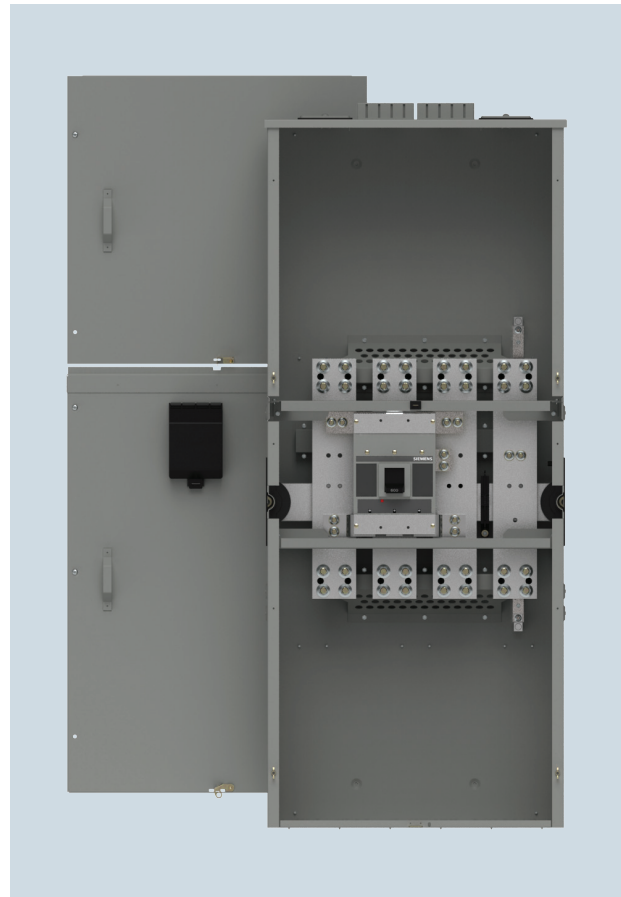

Schematic

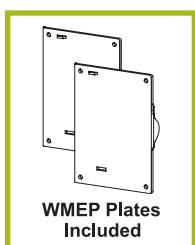
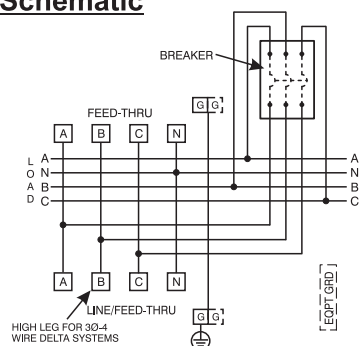

⚠ Restrictions for WBT Feed Thru breaker tapbox units: ⚠

Type WBT breaker tap boxes cannot be used as service equipment. The feed thru conductors must have upstream circuit protection. For feed thru conductor ratings up to 2,000 amps, Siemens Sentron or VL circuit breakers can be used. For feed thru conductor ratings over 2,000 amps but up to 2,400 amps, use Class L fuses. Please note that Siemens type WL circuit breakers CANNOT be used as the direct upstream main for these WBT feed thru breaker tap boxes.

Power Mod

Type WBT Feed Thru Tap Box with Horizontal Bus Breaker

Connects via lugs.

Lug kits not included. Lug kits must be ordered separately per module.

Refer to pages 3-126– 3-127 for lug size options.

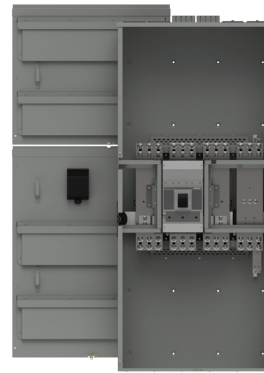

Not for use as service equipment.



Restrictions for WBT Feed Thru breaker tapbox units:

Type WBT breaker tap boxes cannot be used as service equipment. The feed thru conductors must have upstream circuit protection. For feed thru conductor ratings up to 2,000 amps, Siemens Sentron or VL circuit breakers can be used. For feed thru conductor ratings over 2,000 amps but up to 2,400 amps, use Class L fuses. Please note that Siemens type WL circuit breakers CANNOT be used as the direct upstream main for these WBT feed thru breaker tap boxes.

Type WBT Feed Thru Tap Box with Horizontal Bus Breaker

Thermal magnetic circuit breaker modules: 3-phase, 4-wire SN, 240V AC max.

Catalog Number (65KAIC)	Catalog Number (100KAIC) ^②	Catalog Number (65KAIC) Blank Endwall	Catalog Number (100KAIC) Blank Endwall ^②	Breaker Amperage Rating	Feed Through Bus Rating	Breaker Type	Dimensions (inches) ^①		
							Height	Width	Depth
1200A Feed Through Bus									
WBT312X200	WBT312X200U	WBT312X200NH	WBT312X200UNH	200	1200	JXD6	64.58	27.65	13.24
WBT312X250	WBT312X250U	WBT312X250NH	WBT312X250UNH	250	1200	JXD6	64.58	27.65	13.24
WBT312X300	WBT312X300U	WBT312X300NH	WBT312X300UNH	300	1200	JXD6	64.58	27.65	13.24
WBT312X350	WBT312X350U	WBT312X350NH	WBT312X350UNH	350	1200	JXD6	64.58	27.65	13.24
WBT312X400	WBT312X400U	WBT312X400NH	WBT312X400UNH	400	1200	JXD6	64.58	27.65	13.24
WBT312X450	WBT312X450U	WBT312X450NH	WBT312X450UNH	450	1200	LXD6	64.58	27.65	13.24
WBT312X500	WBT312X500U	WBT312X500NH	WBT312X500UNH	500	1200	LXD6	64.58	27.65	13.24
WBT312X600	WBT312X600U	WBT312X600NH	WBT312X600UNH	600	1200	LXD6	64.58	27.65	13.24
2400A Feed Through Bus									
WBT324X200	WBT324X200U	WBT324X200NH	WBT324X200UNH	200	2400	JXD6	77.94	35.55	14.95
WBT324X250	WBT324X250U	WBT324X250NH	WBT324X250UNH	250	2400	JXD6	77.94	35.55	14.95
WBT324X300	WBT324X300U	WBT324X300NH	WBT324X300UNH	300	2400	JXD6	77.94	35.55	14.95
WBT324X350	WBT324X350U	WBT324X350NH	WBT324X350UNH	350	2400	JXD6	77.94	35.55	14.95
WBT324X400	WBT324X400U	WBT324X400NH	WBT324X400UNH	400	2400	JXD6	77.94	35.55	14.95
WBT324X450	WBT324X450U	WBT324X450NH	WBT324X450UNH	450	2400	LXD6	77.94	35.55	14.95
WBT324X500	WBT324X500U	WBT324X500NH	WBT324X500UNH	500	2400	LXD6	77.94	35.55	14.95
WBT324X600	WBT324X600U	WBT324X600NH	WBT324X600UNH	600	2400	LXD6	77.94	35.55	14.95
WBT324X700	WBT324X700U	WBT324X700NH	WBT324X700UNH	700	2400	MXD6	77.94	35.55	14.95
WBT324X800	WBT324X800U	WBT324X800NH	WBT324X800UNH	800	2400	MXD6	77.94	35.55	14.95
WBT324X900	WBT324X900U	WBT324X900NH	WBT324X900UNH	900	2400	NXD6	77.94	35.55	14.95
WBT324X1000	WBT324X1000U	WBT324X1000NH	WBT324X1000UNH	1000	2400	NXD6	77.94	35.55	14.95
WBT324X1200	WBT324X1200U	WBT324X1200NH	WBT324X1200UNH	1200	2400	NXD6	77.94	35.55	14.95

DAS electronic circuit breaker modules with blue light maintenance mode: 3-phase, 4 wire SN, 240V AC max

Catalog Number (65KAIC)	Catalog Number (100KAIC) ^②	Catalog Number (65KAIC) Blank Endwall	Catalog Number (100KAIC) Blank Endwall ^②	Breaker Amperage Rating	Feed Through Bus Rating	Breaker Type	Dimensions (inches) ^①		
							Height	Width	Depth
2400A Feed Through Bus									
WBTM324X12	WBTM324X12U	WBTM324X12NH	WBTM324X12UNH	1200	2400	SND6	79.75	35.55	16.96

① Dimensions subject to changes.

② Non Standard item – extended lead time applies.

Power Mod

Type WBT Feed Thru Tap Box with Horizontal Bus Breaker

Feed Thru Tap Box with Horizontal Bus Breaker: 1200A

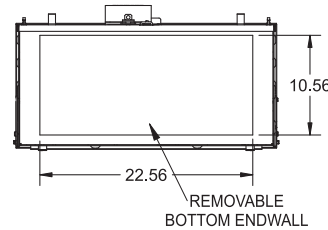
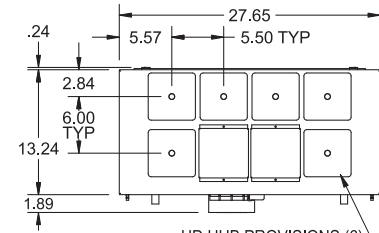
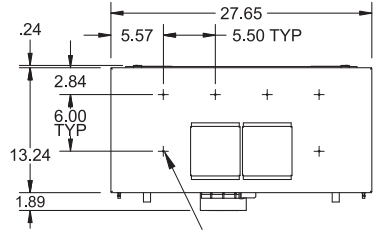
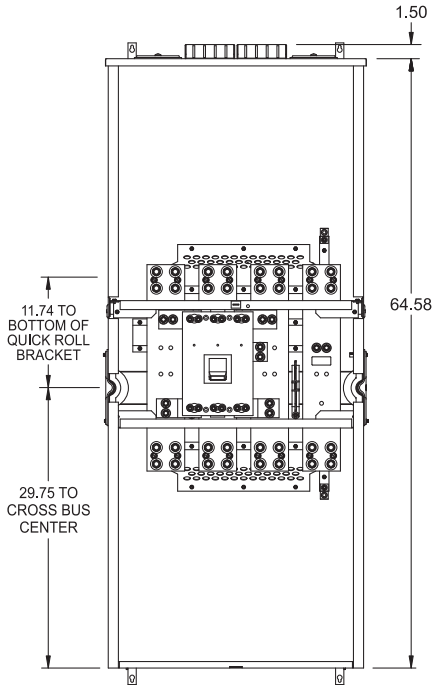

Top Endwall View No Hub Version

WBT312X200NH	WBT312X400NH
WBT312X200UNH	WBT312X400UNH
WBT312X250NH	WBT312X450NH
WBT312X250UNH	WBT312X450UNH
WBT312X300NH	WBT312X500NH
WBT312X300UNH	WBT312X500UNH
WBT312X350NH	WBT312X600NH
WBT312X350UNH	WBT312X600UNH

Top Endwall View Hub Opening Version

WBT312X200	WBT312X400
WBT312X200U	WBT312X400U
WBT312X250	WBT312X450
WBT312X250U	WBT312X450U
WBT312X300	WBT312X500
WBT312X300U	WBT312X500U
WBT312X350	WBT312X600
WBT312X350U	WBT312X600U

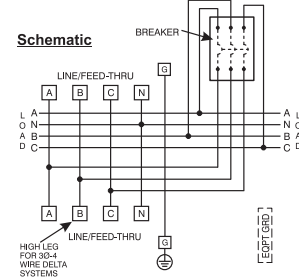

Feed Thru Tap Box with Horizontal Bus Breaker: 2400A

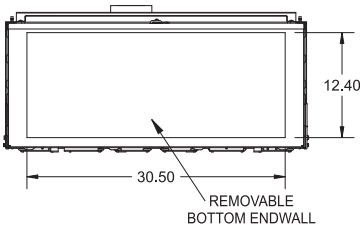
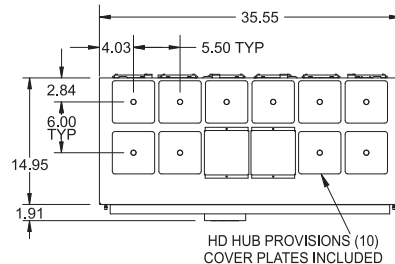
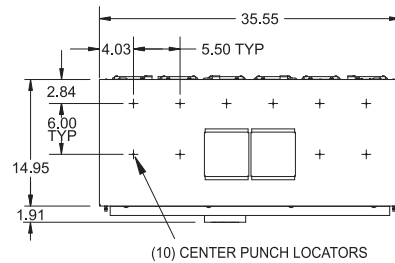
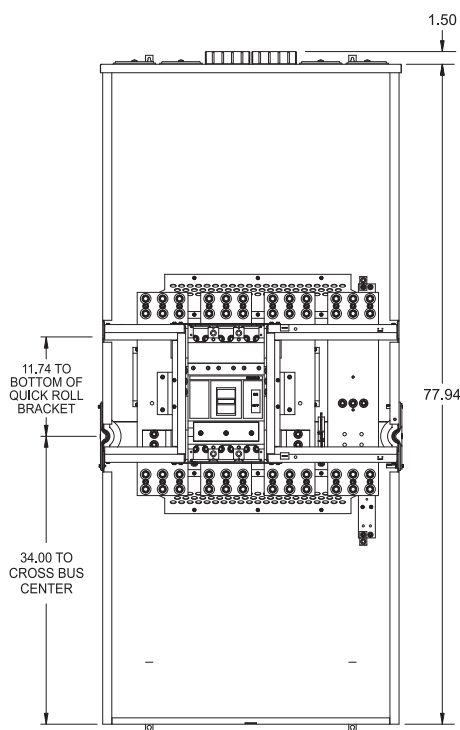

Top Endwall View No Hub Version

WBT324X200NH	WBT324X450NH	WBT324X800NH
WBT324X200UNH	WBT324X450UNH	WBT324X900NH
WBT324X250NH	WBT324X500NH	WBT324X900UNH
WBT324X250UNH	WBT324X500UNH	WBT324X1000NH
WBT324X300NH	WBT324X600NH	WBT324X1000UNH
WBT324X300UNH	WBT324X600UNH	WBT324X1200NH
WBT324X350NH	WBT324X700NH	WBT324X1200UNH
WBT324X350UNH	WBT324X700UNH	WBTM324X12NH
WBT324X400NH	WBT324X800NH	WBTM324X12UNH
WBT324X400UNH		

Top Endwall View Hub Opening Version

WBT324X200	WBT324X450	WBT324X800U
WBT324X200U	WBT324X450U	WBT324X900
WBT324X250	WBT324X500	WBT324X900U
WBT324X250U	WBT324X500U	WBT324X1000
WBT324X300	WBT324X600	WBT324X1000U
WBT324X300U	WBT324X600U	WBT324X1200
WBT324X350	WBT324X700	WBT324X1200U
WBT324X350U	WBT324X700U	WBTM324X12
WBT324X400	WBT324X800	WBTM324X12U
WBT324X400U		

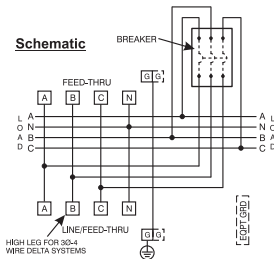

3
METER
CENTERS

Power Mod

Type BFT Main Feed Thru

BFT - Main Feed Thru Modules

The BFT is a main breaker module for the Power Mod group metering line up that has the ability to isolate power to side-mounted modules just like any other Power Mod main breaker module, but also contains feed-through lugs that can be used to supply and isolate power vertically to downstream group metering line ups. This is a revolutionary product in cabled riser applications.

The breaker in the BFT protects both the horizontal bus as well as the vertical cables leaving the top of the module. The BFT can be used as the service entrance point and therefore the neutral and ground is bonded in the unit. The neutral and ground can be un-bonded for non-service entrance applications.

Features include:

- QuickSystem™ features
- Suitable for use as service entrance equipment
- Breaker protects power outgoing, vertically and horizontally
- 1200 amp meets EUSERC requirements
- Incoming and outgoing Power Mod thru bus
- Standard compression lug capability
- 65K AIC standard, 100K AIC available for all models
- Main breaker with broad ampacity ratings from 1200A to 2000A
- Field installable shunt trip
- DAS Blue light models available in 1400-1600 amps"
- For 1200A DAS you must use a 1400A DAS module and have the trip setting dialed down to 1200A.

Main Feed Thru Quick Reference

- 1200-2000A module rating (breaker)
- 1200-2000A feed-thru rating
- 1200A horizontal bus rating
- UL Standard #67
- UL file #E27100
- AIC rating (65K and 100K)
- Voltage: 240V AC max
- Available in single-phase and three-phase
- All swing latches and rivets are stainless steel
- NEMA 1 (indoor)
- G90 galvanized steel
- ANSI 61 paint
- All modules are bottom-feed only
- All modules have no hubs
- EUSERC drawing #347

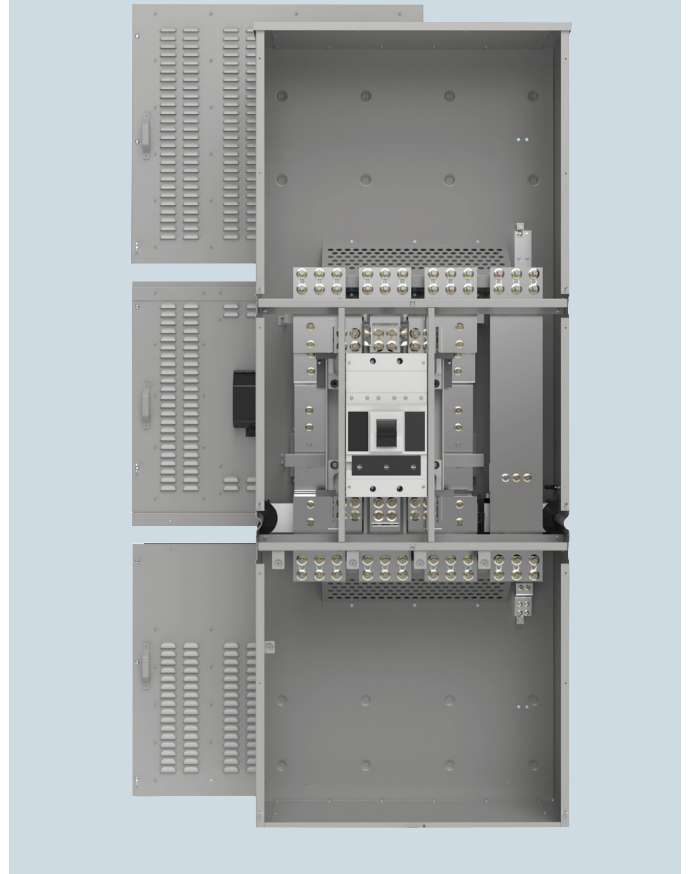
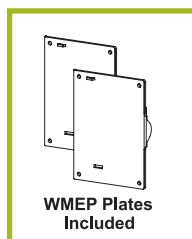

Schematic

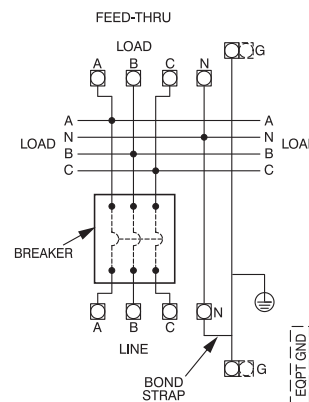

Power Mod

Type BFT Main Feed Thru

Connects via lugs.

Lug kits not included. Lug kits must be ordered separately per module.

Refer to pages 3-126– 3-127 for lug size options.

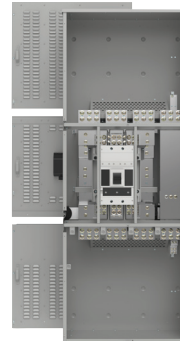

*Suitable for use as service equipment.
Bonding means may be removed for non-service entrance equipment applications.*

Type BFT Main Feed Thru

Thermal magnetic circuit breaker modules: 1-phase, 3-wire SN, 120/240V AC

Catalog Number (65KAIC)	Catalog Number (100KAIC) ^②	Breaker Amperage Rating	Breaker Type (65K AIC)	Breaker Type (100K AIC) ^②	Dimensions (inches) ^①		
					Height	Width	Depth
BFT11200B	BFT11200BU	1200	PXD6	HPXD6	89.78	35.53	15.05
BFT11400B	BFT11400BU	1400	PXD6	HPXD6	89.78	35.53	15.05
BFT11600B	BFT11600BU	1600	PXD6	HPXD6	89.78	35.53	15.05
BFT11800B	BFT11800BU	1800	RXD6	HRXD6	89.78	35.53	15.05
BFT12000B	BFT12000BU	2000	RXD6	HRXD6	89.78	35.53	15.05

Thermal magnetic circuit breaker modules: 3-phase, 4-wire SN, 240V AC max

Catalog Number (65KAIC)	Catalog Number (100KAIC) ^②	Breaker Amperage Rating	Breaker Type (65K AIC)	Breaker Type (100K AIC) ^②	Dimensions (inches) ^①		
					Height	Width	Depth
BFT31200B	BFT31200BU	1200	PXD6	HPXD6	89.78	35.53	15.05
BFT31400B	BFT31400BU	1400	PXD6	HPXD6	89.78	35.53	15.05
BFT31600B	BFT31600BU	1600	PXD6	HPXD6	89.78	35.53	15.05
BFT31800B	BFT31800BU	1800	RXD6	HRXD6	89.78	35.53	15.05
BFT32000B	BFT32000BU	2000	RXD6	HRXD6	89.78	35.53	15.05

DAS electronic circuit breaker modules with blue light maintenance mode: 1-phase, 3 wire SN, 120/240V AC

Catalog Number (65KAIC)	Catalog Number (100KAIC) ^②	Breaker Amperage Rating	Breaker Type (65K AIC)	Breaker Type (100K AIC) ^②	Dimensions (inches) ^①		
					Height	Width	Depth
BFTM11400B	BFTM11400BU	1400	SPD6	SHPD6	89.78	35.53	15.05
BFTM11600B	BFTM11600BU	1600	SPD6	SHPD6	89.78	35.53	15.05

DAS electronic circuit breaker modules with blue light maintenance mode: 3-phase, 4 wire SN, 240V AC max

Catalog Number (65KAIC)	Catalog Number (100KAIC) ^②	Breaker Amperage Rating	Breaker Type (65K AIC)	Breaker Type (100K AIC) ^②	Dimensions (inches) ^①		
					Height	Width	Depth
BFTM31400B	BFTM31400BU	1400	SPD6	SHPD6	89.78	35.53	15.05
BFTM31600B	BFTM31600BU	1600	SPD6	SHPD6	89.78	35.53	15.05

^① Dimensions subject to changes.

^② Non Standard item – extended lead time applies.

Power Mod

Type BFT Main Feed Thru

Type BFT Main Feed Thru: Single-phase

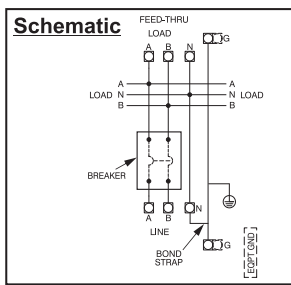
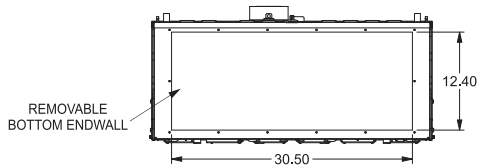
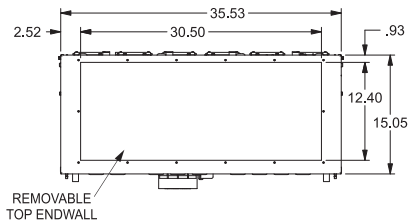

VIEW SHOWN WITHOUT COVERS

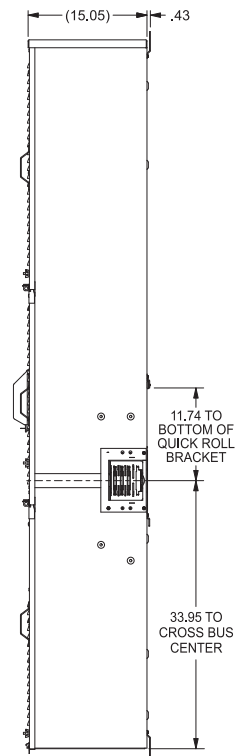
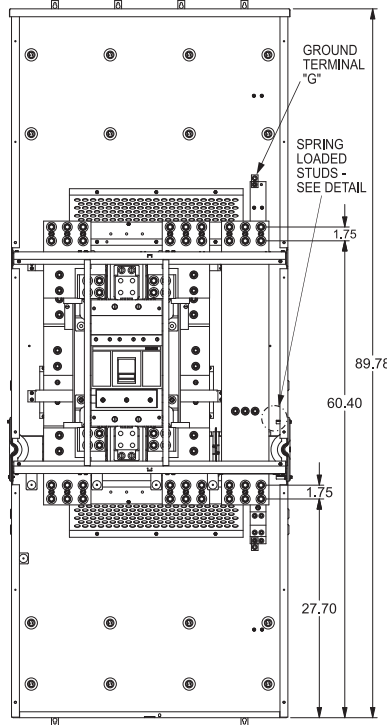

Type BFT Main Feed Thru: Three-phase

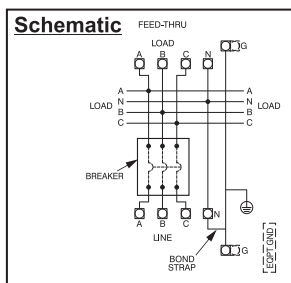
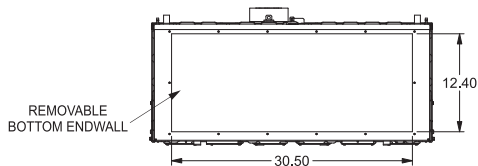
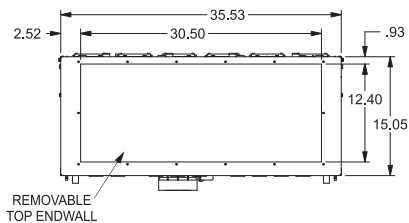

VIEW SHOWN WITHOUT COVERS

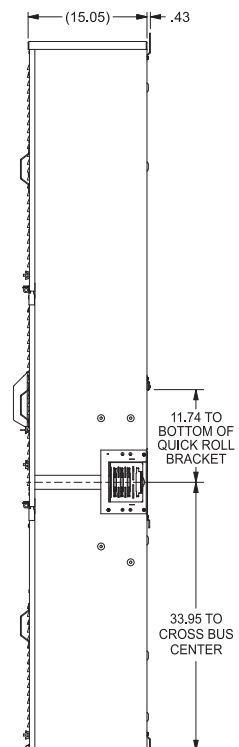
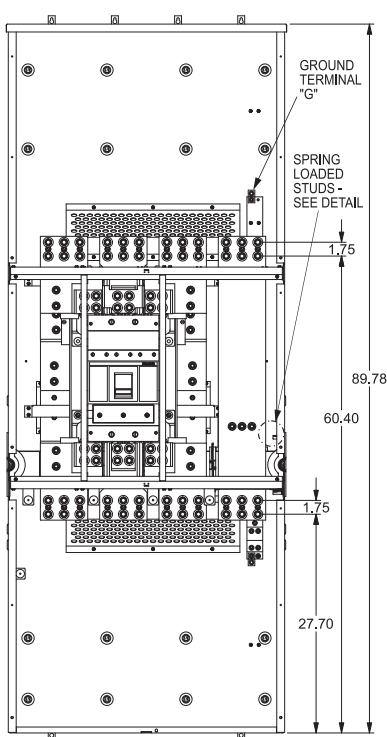

Power Mod

Type WS Standard Switch Mains

Standard Switch Mains

Standard switch modules (type WS) are designed for flexibility, space savings, and durability.

Features include:

- QuickSystem™ features
- Standard compression lug capability
- Invertibility: 400-800 Amp devices can be rotated to accommodate the desired incoming feed direction
- 750 kcmil AL wire options for most models
- 100K AIC standard for all models
- Class T fuse provisions
- Front mounted handle – removes the need for spacers on the side
- Broad ampacity ratings up to 1200 Amps
- Handle is lockable in the ON or OFF positions

Standard Switch Mains quick reference

- 200-1200A module rating
- 1200A horizontal bus rating
- UL Standard # UL98
- UL file #E25506
- AIC rating (100k AIC)
- Voltage:
 - Single phase 120/240V AC max
 - Three phase 240V AC max
- All swing latches and rivets are stainless steel
- NEMA 3R rated
- G90 galvanized steel
- ANSI 61 paint

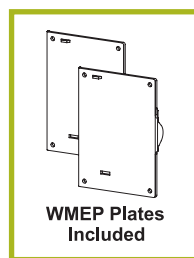

Schematics

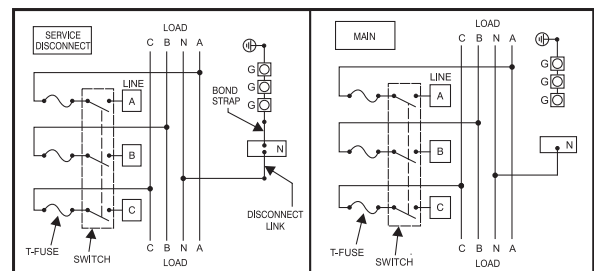

Power Mod

Type WS Standard Switch Mains

Suitable for use as service equipment.
Bonding means may be removed for non-service entrance equipment applications.

Lugs not included on most models.

NEMA 2-stud lugs must be installed by user or utility.

Refer to pages 3-126–3-127 for lug size options.



Fusible switch service entrance modules: 1-phase, 3-wire SN, 120/240V AC^⑥

Catalog number (100k AIC)	Catalog number (100k AIC) Blank Endwall	Rating amps	Service feed	Fuse type ^⑥	Dimensions (inches) ^①			Line side connections	Knockout Diagrams
					Height	Width	Depth		
WMP02U ^{②⑧}	WMP02UNH	200	OH/UG	T	33.00	12.00	13.00	(1) #6 - 250 KCMIL	S-0
WS1400CU ^③	WS1400CUNH	400	OH/UG ^④	T	50.13	15.19	16.31	1 set of 2 studs □ (lugs not included)	S-1
WS1600CU ^③	WS1600CUNH	600	OH/UG ^④	T	50.13	15.19	16.31		
WS1800CU ^③	WS1800CUNH	800	OH/UG ^④	T	50.13	15.19	16.31	2 sets of 2 studs □□ (lugs not included)	S-2
WS11200BU ^{⑤⑦}	—	1200	UG	T	50.06	20.22	16.06	(4) 250- 500 kcmil	S-3

Fusible switch service entrance modules: 3-phase, 4-wire WN, 240V AC Max.^⑥

Catalog number (100k AIC)	Catalog number (100k AIC) Blank Endwall	Rating amps	Service feed	Fuse type ^⑥	Dimensions (inches) ^①			Line side connections	Knockout Diagrams
					Height	Width	Depth		
WMP024U ^{②⑧}	WMP024UNH	200	OH/UG	T	33.00	12.00	13.00	(1) #6 - 250 KCMIL	S-0
WS3400CU ^③	WS3400CUNH	400	OH/UG ^④	T	50.13	15.19	16.31	1 set of 2 studs □ (lugs not included)	S-1
WS3600CU ^③	WS3600CUNH	600	OH/UG ^④	T	50.13	15.19	16.31		
WS3800CU ^③	WS3800CUNH	800	OH/UG ^④	T	50.13	15.19	16.31	2 sets of 2 studs □□ (lugs not included)	S-2
WS31200BU ^{⑤⑦}	—	1200	UG	T	50.06	20.22	16.06	(4) 250-500 kcmil	S-3

① Dimensions shown are representative of outside box dimensions and do not include allowances for mounting bumps, endwalls, covers, hubs, or hardware protrusions. Dimensions are subject to change.
② Additional lead time required. Contact sales office for details. Fusible pull-out switch.

③ Lugs not included. Refer to page 3-126-3-127 for lug size options. NEMA 2-stud compression lugs must be installed by user or utility.
④ Module is invertible – rotate device to point hub openings to appropriate feed direction.
⑤ 500 kcmil max wire range size.
⑥ Fuses not included.

⑦ Device uses a molded case switch (looks like a breaker). Class T fuses must be installed in conjunction with the molded case switch for proper operation.
⑧ Depending on installation details and adjacent product, a WSP spacer module may be required to provide enough clearance for hinges/latches. Contact your local sales person for support

Power Mod

Type WS Standard Switch Mains: Knockout Diagrams

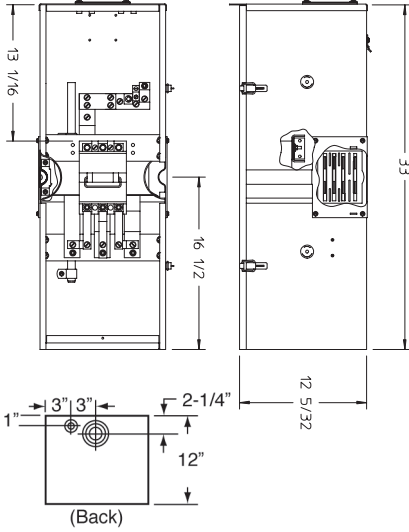
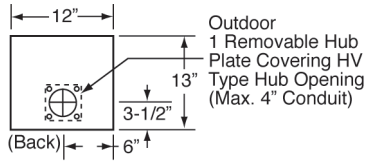

S-0	
WMP02U	WMP024U

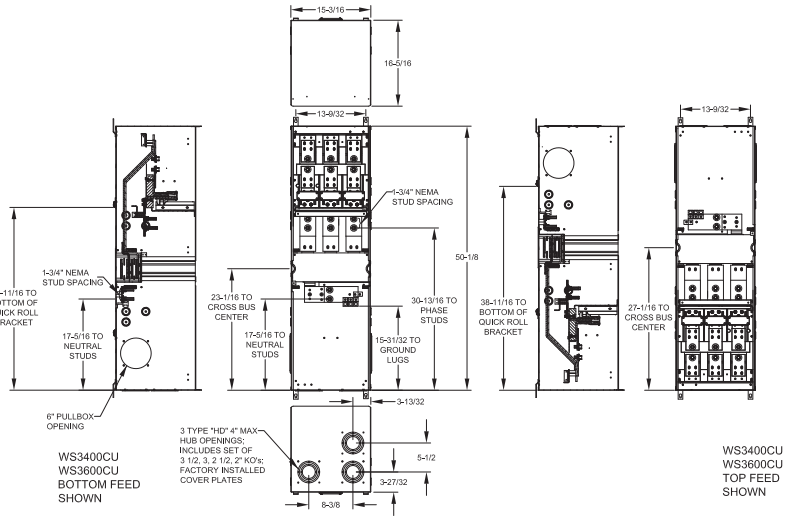

S-1	
WS1400CU WS1600CU	WS3400CU WS3600CU

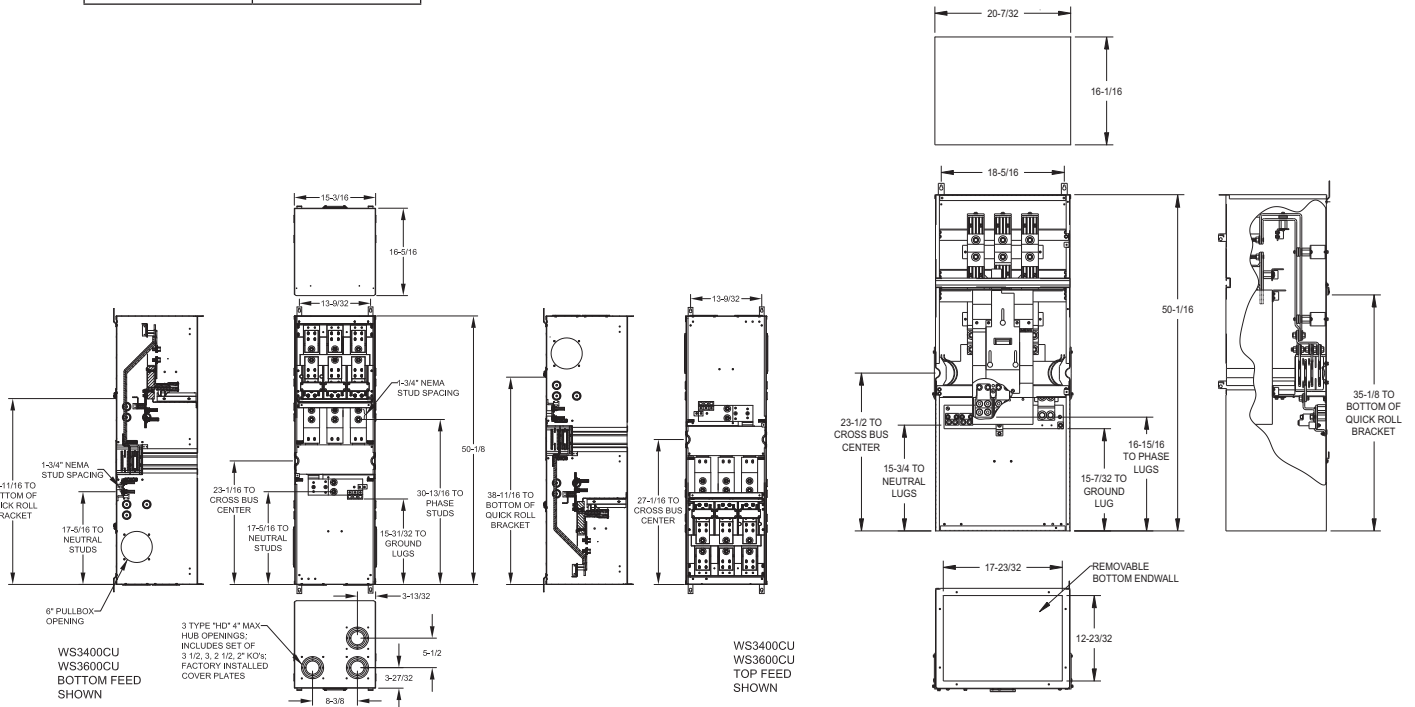

S-2	
WS1800CU	WS3800CU

S-3	
WS11200BU	WS31200BU

Power Mod

Type WES Switch-Pullbox Combinations

Switch-Pullbox Combinations

EUSERC - compliant switch-pullbox combination modules (type WES) offer EUSERC compatibility, a wider range of lug options, and extra space for pulling in conductors.

Features include:

- QuickSystem™ features
- NEMA 2-stud lug mounting pattern
- Broad ampacity ratings up to 1200 Amps
- 750kcmil AL wire options
- 100K AIC standard for all models
- Removable blank bottom endwall
- Front mounted handle - removes the need for spacers on the side
- Class T fuse provisions
- Large removable ground wire trough with generous space for grounding conductors
- Extra ground lugs in each device
- Handle is lockable in the ON or OFF positions

Switch-Pullbox Combinations quick reference

- 400-1200A module rating
- 1200A horizontal bus rating
- UL standard # UL98
- UL file # E25506
- AIC Rating (100k AIC)
- Voltage:
 - Single phase 120/240V AC max
 - Three phase 240V AC max
- All swing latches and rivets are stainless steel.
- NEMA 3R rated
- G90 galvanized steel
- ANSI 61 paint
- EUSERC drawing number 347

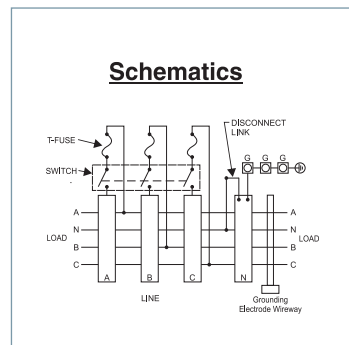
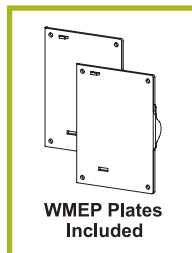
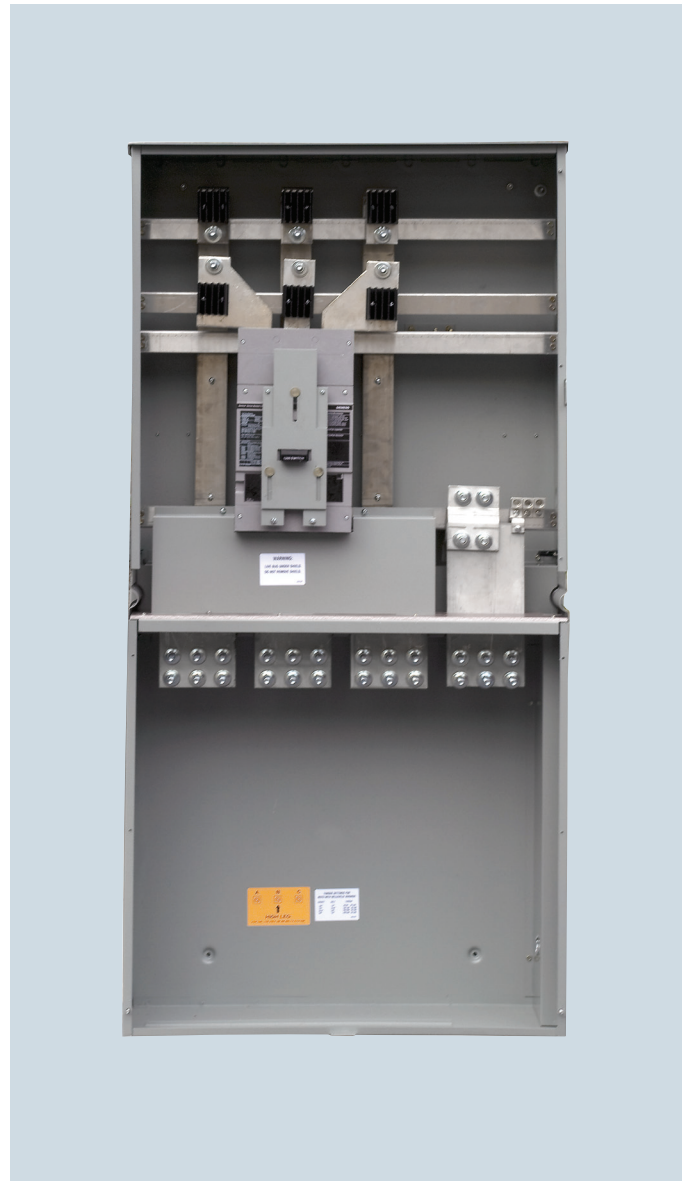

Power Mod

Type WES Switch-Pullbox Combinations

Suitable for use as service equipment.
Bonding means may be removed for non-service entrance equipment applications.



Lugs not included.

NEMA 2-stud lugs must be installed by user or utility.



Refer to pages 3-126–3-127 for lug size options.



Combination fusible switch and pullbox modules: 1-phase, 3-wire SN, 120/240V AC Meets EUSERC requirements^③

Catalog number (100k AIC)	Rating Amps	Service feed	Fuse type ^②	Dimensions (inches) ^①			Line side ^② connections (lugs not included)	Knockout Diagram
				Height	Width	Depth		
WES1400BU	400	UG	T	54.06	29.19	15.94	1 set of 2 studs 	ES-1
WES1600BU	600	UG	T	54.06	29.19	15.94	2 sets of 2 studs 	ES-2
WES1800BU	800	UG	T	54.06	29.19	15.94		
WES11200BU ^④	1200	UG	T	68.97	34.25	13.47	3 sets of 2 studs 	ES-3

Combination fusible switch and pullbox modules: 3-phase, 4-wire SN, 240V AC max. Meets EUSERC requirements^③

Catalog number (100k AIC)	Rating Amps	Service feed	Fuse type	Dimensions (inches) ^①			Line side ^② connections (lugs not included)	Knockout Diagram
				Height	Width	Depth		
WES3400BU	400	UG	T	54.06	29.19	15.94	1 set of 2 studs 	ES-1
WES3600BU	600	UG	T	54.06	29.19	15.94	2 sets of 2 studs 	ES-2
WES3800BU	800	UG	T	54.06	29.19	15.94		
WES31200BU ^④	1200	UG	T	68.97	34.25	13.47	3 sets of 2 studs 	ES-3

① Dimensions shown are representative of outside box dimensions and do not include allowances for mounting bumps, endwalls, covers, hubs, or hardware protrusions. Dimensions are subject to change.

② Lugs not included. Refer to page 3-126–3-127 for lug size options. NEMA 2-stud compression lugs must be installed by user or utility.

③ Fuses not included.

④ Device uses a molded case switch (looks like a breaker). Class T fuses must be installed in conjunction with the molded case switch for proper operation.

Power Mod

Type WES Switch-Pullbox Combinations: Knockout Diagrams

3
METER
CENTERS

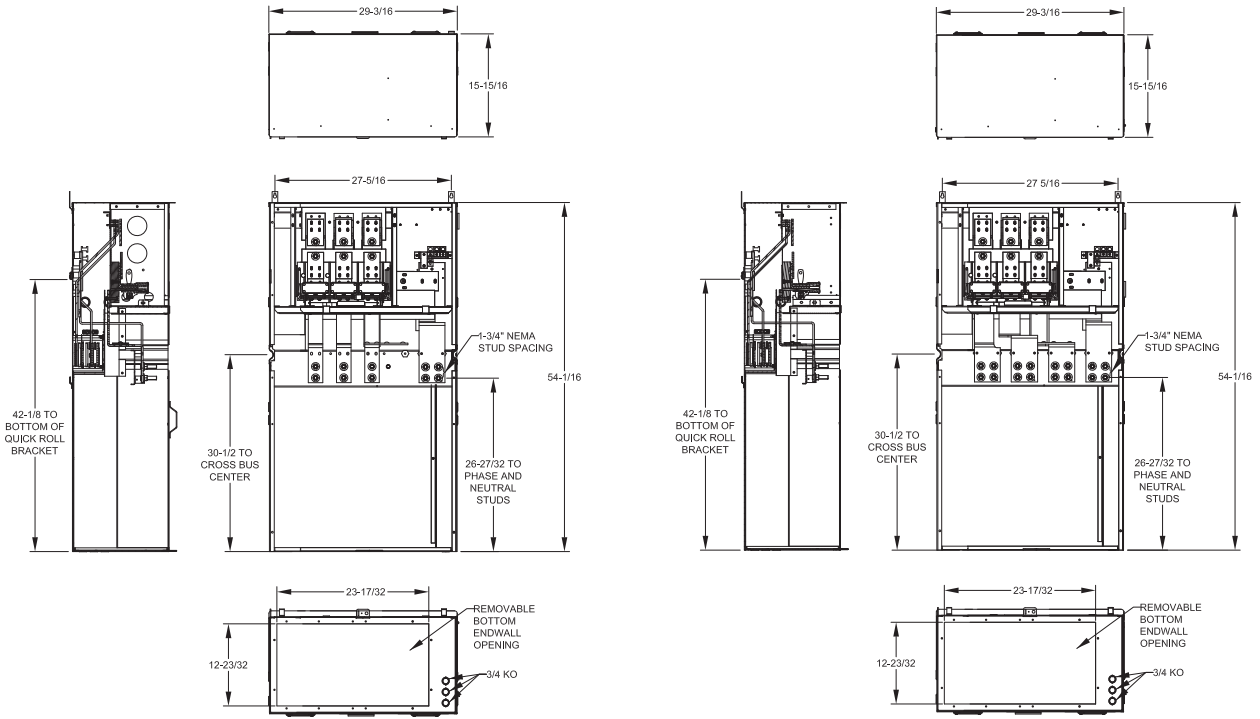

ES-1
WES1400BU WES3400BU

ES-2
WES1600BU WES3600BU
WES1800BU WES3800BU

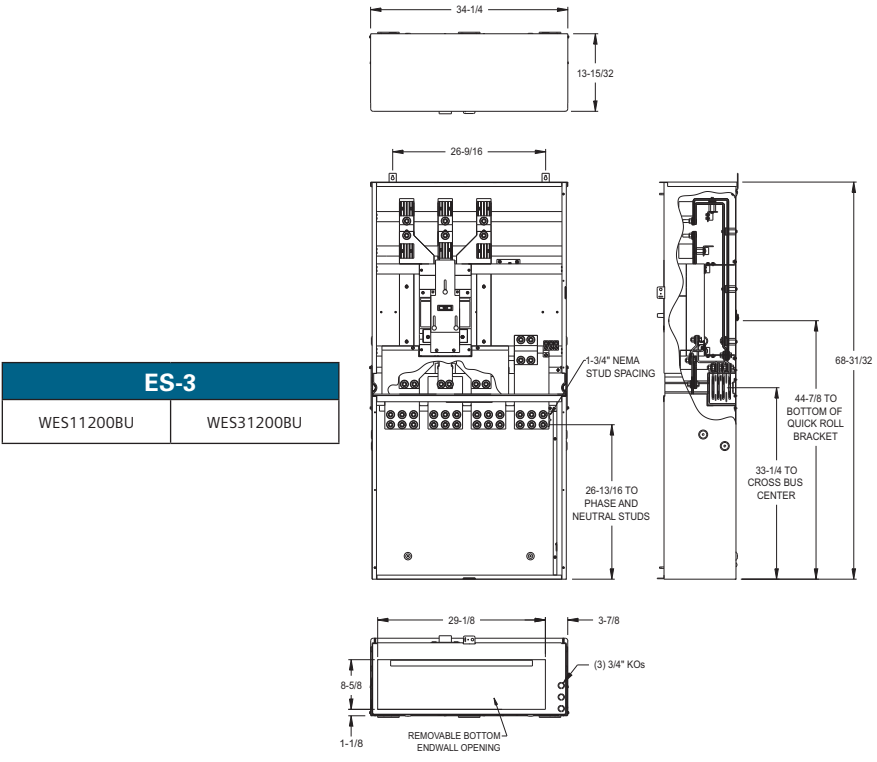

ES-3
WES11200BU WES31200BU

Power Mod

Type WXS Switch Units

Cross Bus Switch modules

Cross Bus switch modules (type WXS) offer two distinct functions: first they can be used to connect Siemens Sentron Busway to a Power Mod line-up. Second they can be utilized to offer lower service disconnect ampacities or unique configurations where an incoming tap box is preferred.

Features include:

- QuickSystem™ features
- Incoming and outgoing bus connections (right to left or left to right)
- Standardized connection points to Siemens Sentron Busway
- 100K AIC standard for all models
- Externally accessible switch handle with padlock capability
- Class T fuse provisions
- Invertibility: Devices must be installed with line and load side in correct order
- Handle is lockable in the ON or OFF positions

Circuit Breaker-Pullbox Combinations Quick Reference

- 400-800A module rating
- 1200A horizontal bus rating
- UL Standard # UL98
- UL file # E25506
- AIC rating (100k)
- Voltage:
 - Single phase 120/240V AC max
 - Three phase 240V AC max
- All swing latches and rivets are stainless steel
- NEMA 3R rated
- G90 galvanized steel
- ANSI 61 paint



Schematic

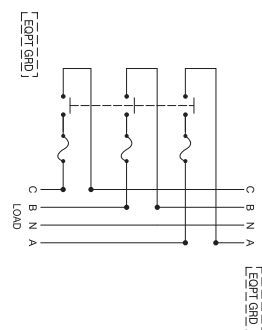

Power Mod

Type WXS Switch Units

Not suitable for use as service equipment.

Connects via
horizontal bussing
only - NO LUGS



1-phase, 3-wire SN, 120/240V AC^②

Catalog number (100k AIC)	Ampere rating	Service Feed	Fuse Type	Dimensions ^①			Knockout diagram
				Height	Width	Depth	
WXS1400NU	400	Horizontal Bus	T	35.62	18.16	16.31	WXS
WXS1600NU	600	Horizontal Bus	T	35.62	18.16	16.31	
WXS1800NU	800	Horizontal Bus	T	35.62	18.16	16.31	

3-phase, 4-wire SN, 240V AC max^②

Catalog Number (100k AIC) ^③	Ampere rating	Service Feed	Fuse Type	Dimensions ^①			Knockout diagram
				Height	Width	Depth	
WXS3400NU	400	Horizontal Bus	T	35.62	18.16	16.31	WXS
WXS3600NU	600	Horizontal Bus	T	35.62	18.16	16.31	
WXS3800NU	800	Horizontal Bus	T	35.62	18.16	16.31	

^① Dimensions shown are representative of outside box dimensions and do not include allowances for mounting bumps, endwalls, covers, hubs, or hardware protrusions. Dimensions are subject to change.

^② Connects via horizontal bussing only – NO LUGS.

Power Mod

Type WXS Switch Units: Knockout Diagrams

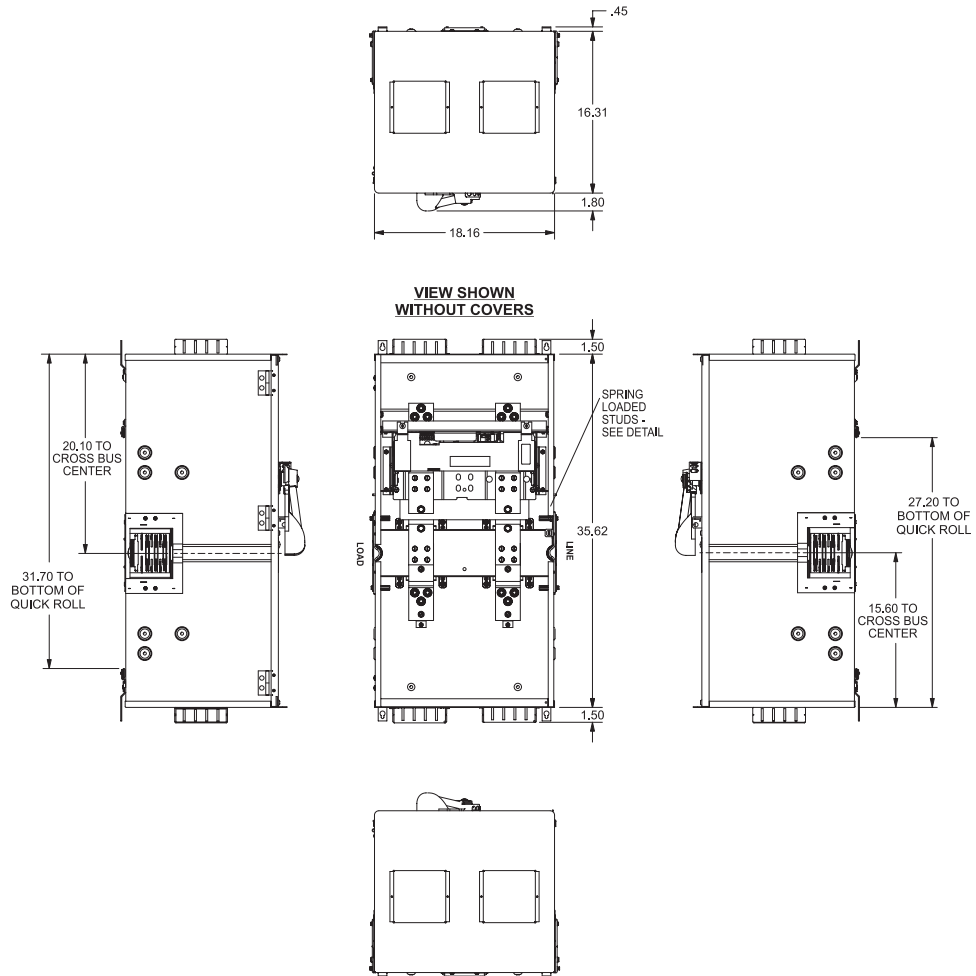

WXS	
WXS1400NU	WXS3400NU
WXS1600NU	WXS3600NU
WXS1800NU	WXS3800NU

Power Mod

Type WTB Standard Tap boxes

Standard Tap boxes

Standard tap box modules (type WTB) are designed for versatility, space savings, and flexibility.

Features include:

- QuickSystem™ features
- Standard compression lug capability
- Invertibility: some devices can be rotated to accommodate the desired incoming feed direction (1600 Amps and lower)
- 750 kcmil AL wire options for most models
- 100K AIC standard for all models
- Broad ampacity ratings from 400 to 2400 Amps
- Line and load capability- service entrance and sub feed rated

Standard Tapbox quick reference

- 400-2400A module rating
- 1200A horizontal bus rating
- UL Standard # UL67
- UL file # E27100
- AIC rating (100K AIC)
- Voltage
 - Single phase 120/240V AC max
 - Three phase 240V AC max
- All swing latches and rivets are stainless steel.
- NEMA 3R rated
- G90 galvanized steel
- ANSI 61 paint

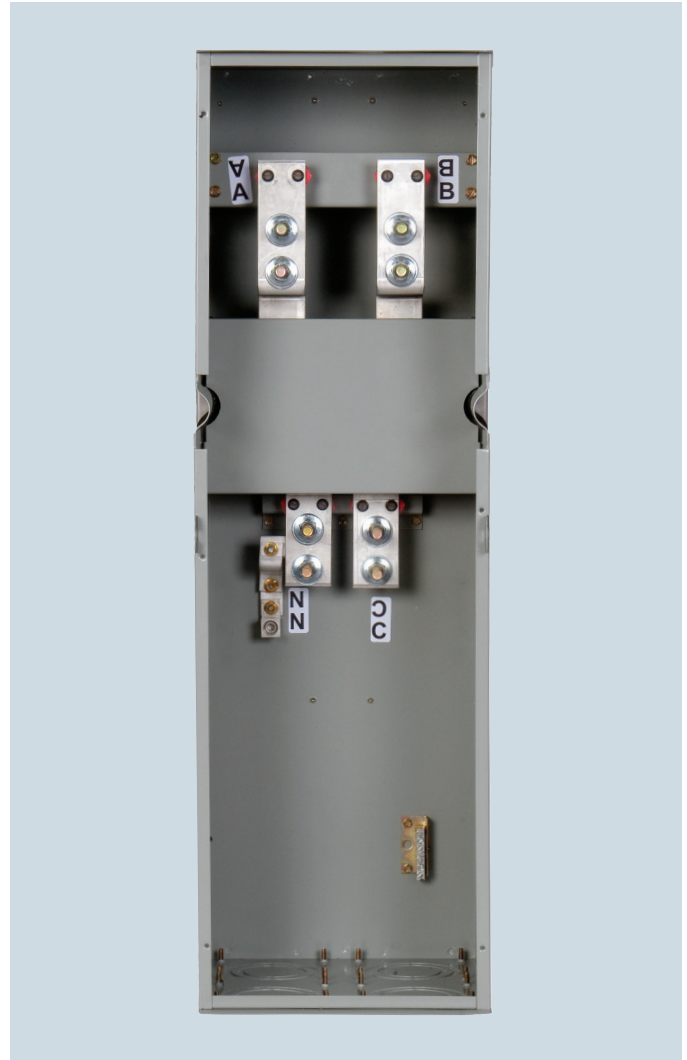

Restrictions for 1600-2400amp type WTB Power Mod Tap Boxes:



When the 1600, 2000, or 2400amp tap boxes are used as service entrance equipment (fed directly from utility transformer) or when the supply originates from a Class L fuse or Siemens WL circuit breaker there are restrictions on the use of an additional down-stream horizontal cross-bus connected WTBN, WTB, WET, or WT type Power Mod tap boxes. When another tap box is connected to the same meter-bank, a type "WXB" module must be used as protection for the down-stream tap box (placed between the incoming WTB tap box and the downstream outgoing tap box). This restriction does NOT apply if the tap box is fed from a Siemens Sentron or VL series molded case circuit breaker. Note that the maximum amperage for a Siemens Sentron circuit breaker is 2,000amps.

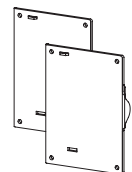

WMEP Plates Included

Power Mod

Type WTB Standard Tap boxes

⚠ Restrictions for 1600-2400amp type WTB Power Mod Tap Boxes: ⚠

When the 1600, 2000, or 2400amp tap boxes are used as service entrance equipment (fed directly from utility transformer) or when the supply originates from a Class L fuse or Siemens WL circuit breaker there are restrictions on the use of an additional down-stream horizontal cross-bus connected WTBN, WTB, WET, or WT type Power Mod tap boxes. When another tap box is connected to the same meter-bank, a type "WXB" module must be used as protection for the down-stream tap box (placed between the incoming WTB tap box and the downstream outgoing tap box). This restriction does NOT apply if the tap box is fed from a Siemens Sentron or VL series molded case circuit breaker. Note that the maximum amperage for a Siemens Sentron circuit breaker is 2,000amps.

Lugs not included.







NEMA 2-stud lugs must be installed by user or utility.

Refer to pages 3-126 – 3-127 for lug size options.









Suitable for use as service equipment. Bonding means may be removed for non-service entrance equipment applications.

Tap box modules: 1-phase, 3-wire WN, 120/240V AC^⑤

Catalog number (100k AIC)	Catalog number (100k AIC) Blank Endwall	Ampere rating ^③	Service feed	Dimensions (inches) ^①			Line side connections ^② (lugs not included)	KO Diagram
				Height	Width	Depth		
WTB1400CU	WTB1400CUNH	400	OH/UG ^④	40.13	12.22	13.19	1 set of 2 studs 	T-1
WTB1800CU	WTB1800CUNH	800	OH/UG ^④	40.13	12.22	13.19	2 sets of 2 studs 	T-2
WTB11200CU	WTB11200CUNH	1200	OH/UG ^④	47.13	15.61	13.31		T-3
WTB11600CU ^⑥	WTB11600CUNH ^⑥	1600	OH/UG ^④	50.25	25.09	13.81	3 sets of 2 studs 	T-4
WTB12000TU ^⑥	WTB12000TUNH ^⑥	2000	OH	67.94	35.00	14.78	3 sets of 2 studs 	T-6
WTB12000BU ^⑥	—		UG					
WTB12400TU ^⑥	WTB12400TUNH ^⑥	2400	OH	67.94	35.00	14.78	3 sets of 2 studs 	
WTB12400BU ^⑥	—		UG				Optional 4 sets of 2 studs ^{⑦⑧} 	

Tap box modules: 3-phase, 4-wire SN, 240V AC Max.^⑤

Catalog number (100k AIC)	Catalog number (100k AIC) Blank Endwall	Ampere rating ^③	Service feed	Dimensions (inches) ^①			Line side connections ^② (lugs not included)	KO Diagram
				Height	Width	Depth		
WTB3400CU	WTB3400CUNH	400	OH/UG ^④	40.13	12.22	13.19	1 set of 2 studs 	T-1
WTB3800CU	WTB3800CUNH	800	OH/UG ^④	40.13	12.22	13.19	2 sets of 2 studs 	T-2
WTB31200CU	WTB31200CUNH	1200	OH/UG ^④	60.31	15.61	17.75		T-3
WTB31600CU ^⑥	WTB31600CUNH ^⑥	1600	OH/UG ^④	50.25	25.09	13.81	3 sets of 2 studs 	T-5
WTB32000TU ^⑥	WTB32000TUNH ^⑥	2000	OH	67.94	35.00	14.78	3 sets of 2 studs 	T-6
WTB32000BU ^⑥	—		UG					
WTB32400TU ^⑥	WTB32400TUNH ^⑥	2400	OH	67.94	35.00	14.78	3 sets of 2 studs 	
WTB32400BU ^⑥	—		UG				Optional 4 sets of 2 studs ^{⑦⑧} 	

① Dimensions shown are representative of outside box dimensions and do not include allowances for mounting bumps, endwalls, covers, hubs, or hardware protrusions. Dimensions are subject to change.
 ② Lugs not included. Refer to page 3-126 – 3-127 for lug size options. 750 conductor size available NEMA 2-stud

compression lugs must be installed by user or utility.
 ③ 1200 amp maximum feed per side, any unit over 1200A must be used as a center fed main.
 ④ Module is invertible- rotate device to point hub openings to appropriate feed direction.

⑤ QuickConnect not included. If used for load side application an additional coupler must be ordered.
 ⑥ Please see restriction note above.
 ⑦ Please see lug kit number LK18500N2C on pages 3-126 – 3-127. For use with 500kcmil ONLY.
 ⑧ Fits 2400amp models ONLY.

Power Mod

Type WTB Standard Tap boxes: Knockout Diagrams

3
METER
CENTERS

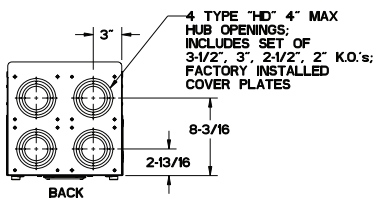
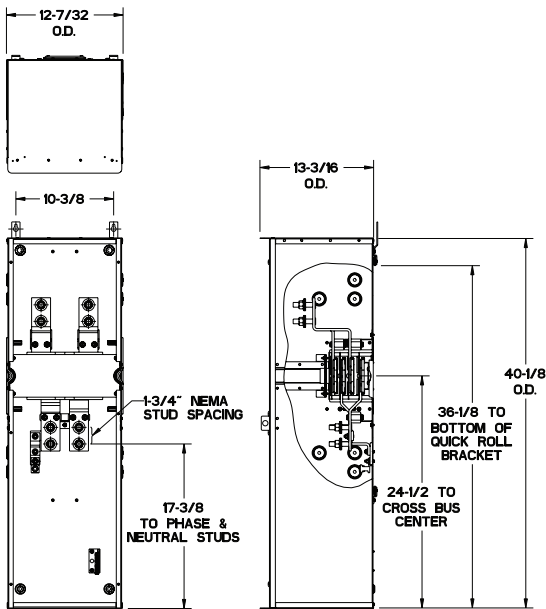

T-1
WTB1400CU
WTB3400CU

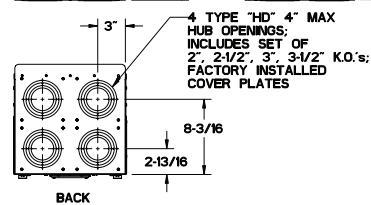
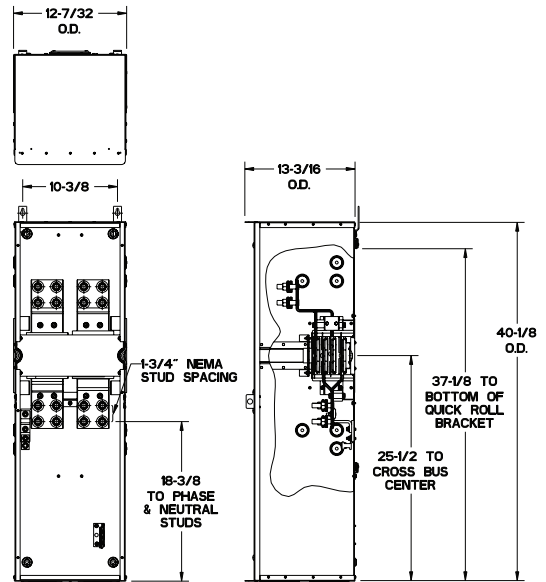

T-2
WTB1800CU
WTB3800CU

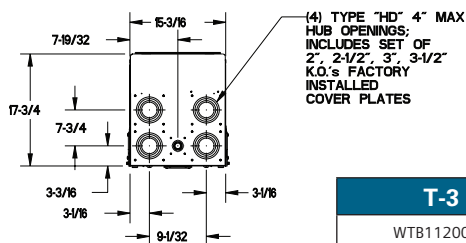
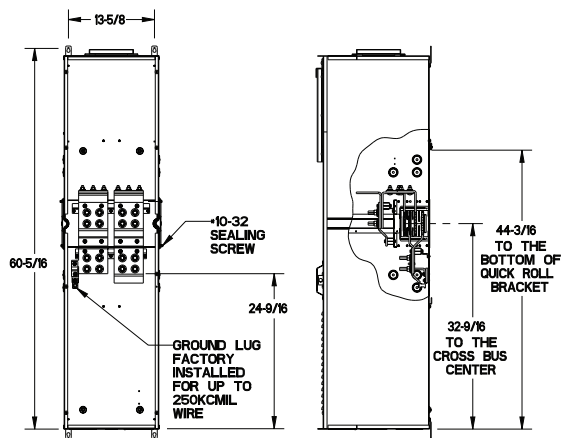

T-3
WTB11200CU
WTB31200CU

Power Mod

Type WTB Standard Tap boxes: Knockout Diagrams

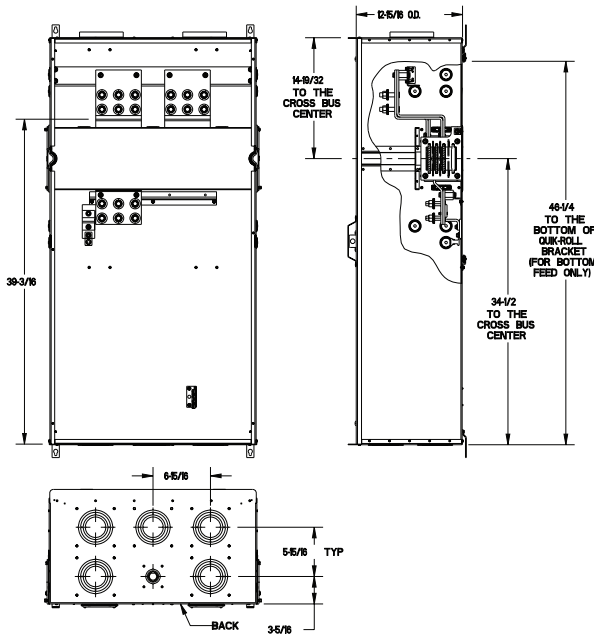

T-4
WTB11600CU

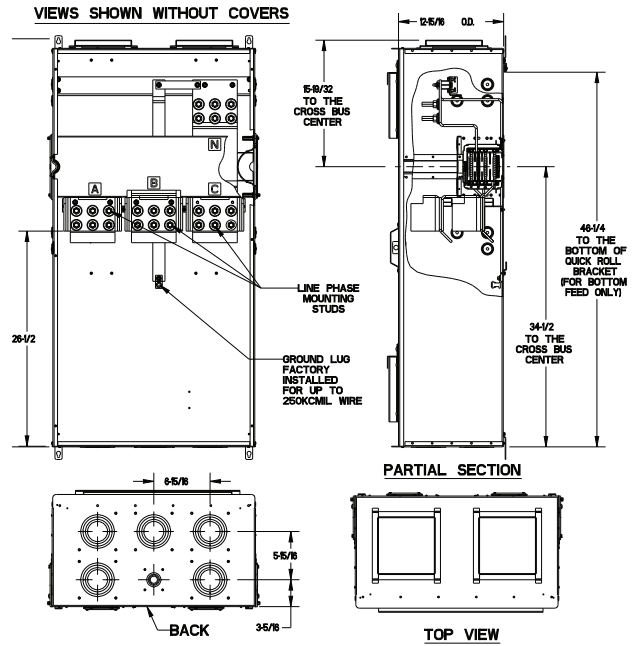

T-5
WTB31600CU

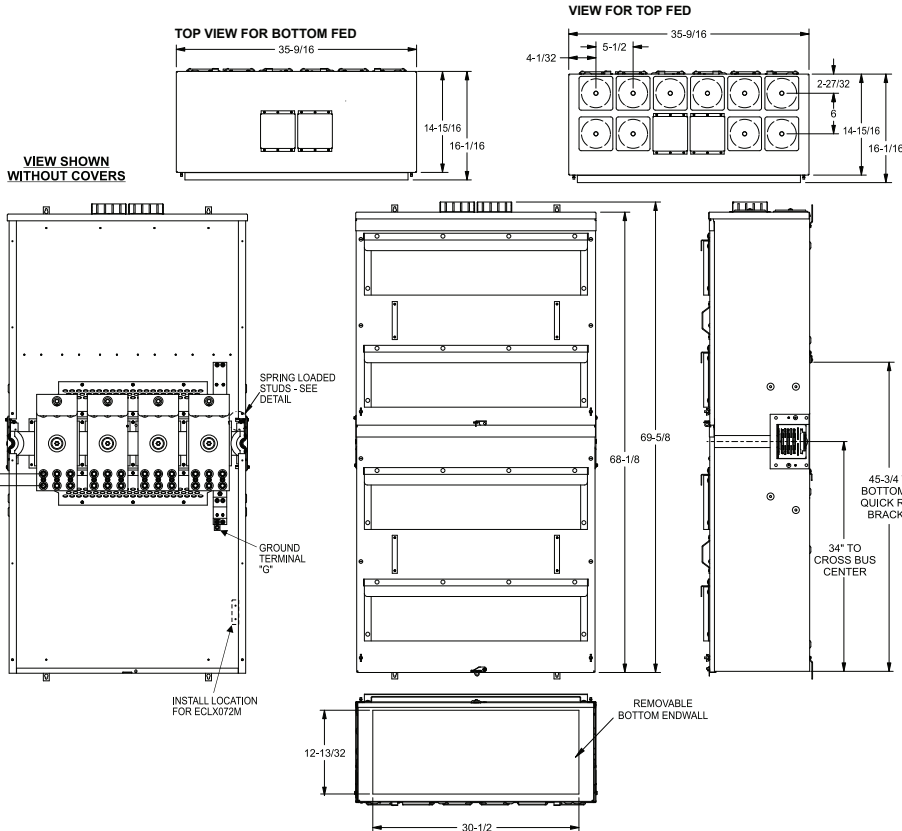

T-6

WTB12000TU
WTB12000BU
WTB12400TU
WTB12400BU
WTB32000TU
WTB32000BU
WTB32400TU
WTB32400BU

Power Mod

Type WET Tap box - Pullbox Combinations

Tap box – Pullbox Combinations

EUSERC – compliant Tap box – Pullbox Combination modules (type WET) offer EUSERC compatibility, a wider range of lug options, and extra space for pulling in conductors.

Features include:

- QuickSystem™ features
- Standard compression lug capability
- 750 kcmil AL wire options for most models
- 100K AIC standard for all models
- Broad ampacity ratings from 400 to 1200 Amps
- Removable bottom endwall

Tap box – Pullbox Combination quick reference

- 400-1200A module rating
- 1200A horizontal bus rating
- UL Standard #'s UL67
- UL file # E27100
- AIC Rating (100k)
- Voltage
 - Single phase 120/240V AC max
 - Three phase 240V AC max
- All swing latches and rivets are stainless steel.
- NEMA 3R rated
- G90 galvanized steel
- ANSI 61 paint
- EUSERC drawing numbers 343 and 347

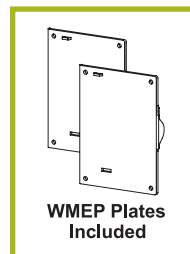

Power Mod



Type WET Tap box - Pullbox Combinations

Suitable for use as service equipment.
Bonding means may be removed for non-service entrance equipment applications.



Lugs not included.
NEMA 2-stud lugs must be installed by user or utility.
Refer to pages 3-126–3-127 for lug size options.



EUSERC tap box modules: 1-phase, 3-wire SN, incoming, 120/240V AC Meets EUSERC requirements

Catalog number (100k AIC)	Ampere rating	Service feed ^②	Dimensions (inches) ^①			Line side connections ^② (lugs not included)	Knockout Diagram
			Height	Width	Depth		
WET1400BU	400	UG	46.19	17.63	8.56	1 set of 2 studs 	ET-1
WET1800BU	800	UG	50.19	27.13	11.38	2 sets of 2 studs 	ET-2
WET11200BU	1200	UG	50.19	35.19	11.38	3 sets of 2 studs 	ET-3

EUSERC tap box modules: 3-phase, 4-wire SN, incoming, 240V AC max. Meets EUSERC requirements

Catalog number (100k AIC)	Ampere rating	Service feed	Dimensions (inches) ^①			Line side connections ^② (lugs not included)	Knockout Diagram
			Height	Width	Depth		
WET3400BU	400	UG	46.19	17.63	8.56	1 set of 2 studs 	ET-1
WET3800BU	800	UG	50.19	27.13	11.38	2 sets of 2 studs 	ET-2
WET31200BU	1200	UG	50.19	35.19	11.38	3 sets of 2 studs 	ET-3

① Dimensions shown are representative of outside box dimensions and do not include allowances for mounting bumps, endwalls, covers, hubs, or hardware protrusions. Dimensions are subject to change.

② Lugs not included. Refer to page 3-126–3-127 for lug size options. NEMA 2-stud compression lugs must be installed by user or utility.

Power Mod

Type WET Tap box - Pullbox Combinations: Knockout Diagrams

3
METER
CENTERS

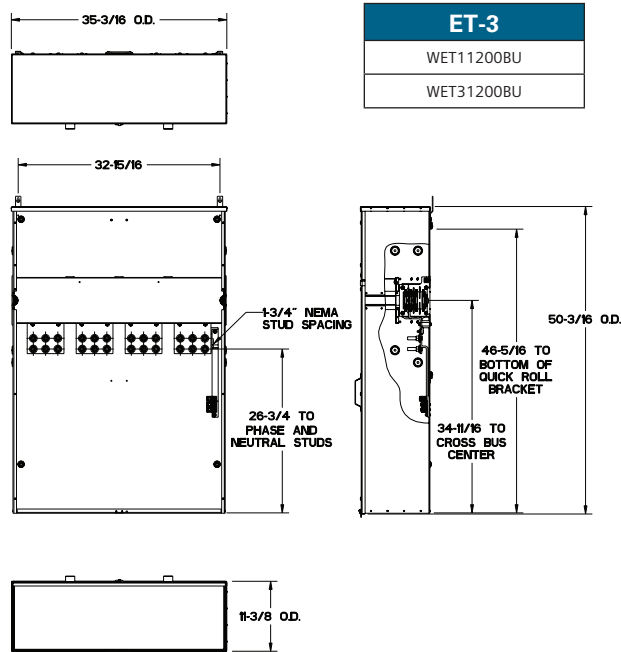
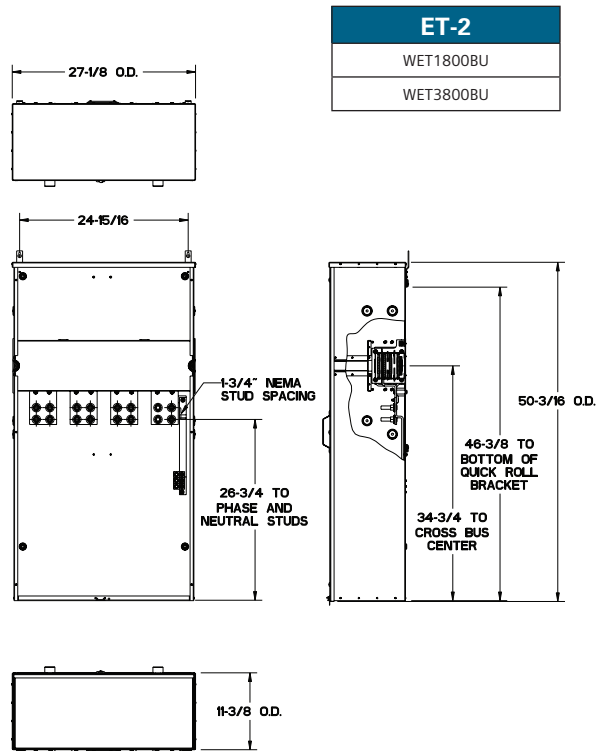
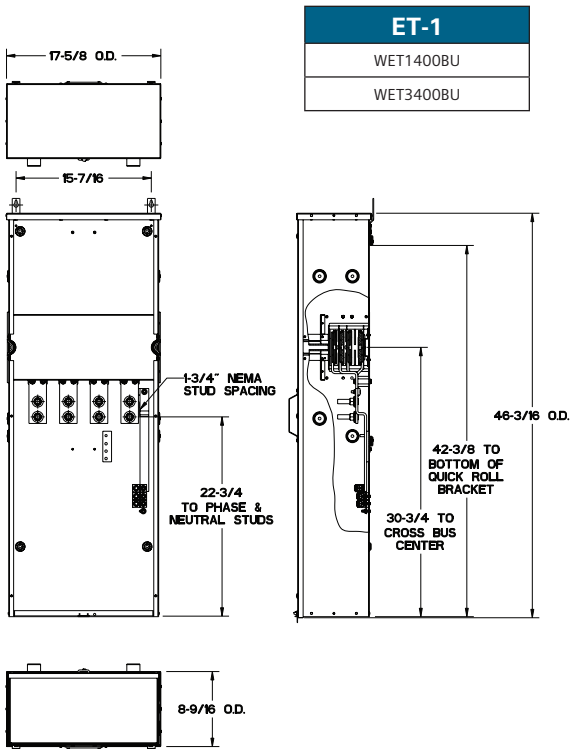

Power Mod

Type WT Feed Thru Tap box

Feed Thru Tap box

Family (type WT), the Feed Thru Tap box features cable in cable out lugs. Valuable for use in mid rise and high rise projects.

Features include:

- QuickSystem features
- Standard compression lug capability
- 250kcmil Al wire options
- 100k AIC standard
- Removable bottom endwell
- Broad ampacity ratings from 400 to 2400 Amps

Feed Thru Tap box quick reference

- 400-2400A module rating
- 400-2400A feed-thru rating
- 1200A horizontal bus rating
- UL standard 67
- UL file no. E27100
- AIC rating (100k AIC)
- Voltage:
 - Single phase 120/240V AC max.
 - Three phase, 240V AC max
- All swing latches and rivets are stainless steel.
- NEMA 3R rated
- G90 galvanized steel
- ANSI 61 paint



Restrictions for Power Mod 1600-2400amp type WT Feed Thru Tap Boxes:



Type WT feed thru tap boxes cannot be used as service equipment. The feed thru conductors must have upstream circuit protection. When fed by a Class L fuse, there are restrictions on the use of additional down-stream horizontal cross-bus connected WTBN, WET, or WT type Power Mod tap boxes. When another tap box is connected to the same meter-bank, a type WXB module must be used as protection for the downstream tap box (placed between the incoming WT tap box and the downstream outgoing tap box). This restriction does NOT apply if the tap box is fed from a Siemens Sentron or VL series molded case circuit breaker. Note that the maximum amperage for a Siemens Sentron circuit breaker is 2,000A. Please note that Siemens type WL circuit breakers CANNOT be used to feed WT Power Mod tap boxes.

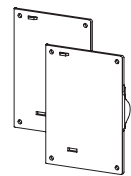

**WMEP Plates
Included**

Power Mod

Type WT Feed Thru Tap box



Restrictions for 1600-2400amp type WT Power Mod Pull-Thru Tap Boxes:



Type WT feed thru tap boxes cannot be used as service equipment. The feed thru conductors must have upstream circuit protection. When fed by a Class L fuse, there are restrictions on the use of additional down-stream horizontal cross-bus connected WTBN, WET, or WT type Power Mod tap boxes. When another tap box is connected to the same meter-bank, a type WXB module must be used as protection for the downstream tap box (placed between the incoming WT tap box and the downstream outgoing tap box). This restriction does NOT apply if the tap box is fed from a Siemens Sentron or VL series molded case circuit breaker. Note that the maximum amperage for a Siemens Sentron circuit breaker is 2,000A. Please note that Siemens type WL circuit breakers CANNOT be used to feed WT Power Mod tap boxes.

Lug kits not included.

(2) Lug kits must be ordered separately per module.

Refer to pages 3-126–3-127 for lug size options.



Not suitable for use as service equipment.

Feed Thru Tap box modules: 1-phase, 120/240V AC

Catalog number (100k AIC)	Catalog number (100k AIC) Blank Endwall	Ampere rating	Service feed	Dimensions (inches) ^①			Line side connections ^②	KO Diagram
				Height	Width	Depth		
WT1400PU	WT1400PUNH	400	OH/UG	59.25	17.25	8.13	1 set of 2 studs	
WT1800PU	WT1800PUNH	800		62.25	26.75	11.13	2 sets of 2 studs	
WT11200PU	WT11200PUNH	1200		68.34	35.19	11.41	3 sets of 2 studs	WP-1
WT11600PU ^{③④}	WT11600PUNH ^{③④}	1600		67.94	35	14.78		
WT12000PU ^{③④}	WT12000PUNH ^{③④}	2000		67.94	35	14.78	3 sets of 2 studs Optional 4 sets of 2 studs ^⑤	WP-2
WT12400PU ^{③④}	WT12400PUNH ^{③④}	2400						

Feed Thru Tap box modules: 3-phase, 240V AC

Catalog number (100k AIC)	Catalog number (100k AIC) Blank Endwall	Ampere rating	Service feed	Dimensions (inches) ^①			Line side connections ^②	KO Diagram
				Height	Width	Depth		
WT3400PU	WT3400PUNH	400	OH/UG	59.25	17.25	8.13	1 set of 2 studs	
WT3800PU	WT3800PUNH	800		62.25	26.75	11.13	2 sets of 2 studs	
WT31200PU	WT31200PUNH	1200		68.34	35.19	11.41	3 sets of 2 studs	WP-1
WT31600PU ^{③④}	WT31600PUNH ^{③④}	1600		67.94	35	14.78		
WT32000PU ^{③④}	WT32000PUNH ^{③④}	2000		67.94	35	14.78	3 sets of 2 studs Optional 4 sets of 2 studs ^⑤	WP-2
WT32400PU ^{③④}	WT32400PUNH ^{③④}	2400						

① Dimensions shown are representative of outside box dimensions and do not include allowances for mounting bumps, endwalls, covers, hubs, or hardware protrusions. Dimensions are subject to change.

② Lugs not included. Refer to page 3-126–3-127 for lug size options. (2) Lug kits must be ordered separately per module. Refer to page 3-126 – 3-127 for lug size options.

③ 1200 amp maximum feed per side-must be used as a center fed main.

④ Please see restriction note above.

⑤ Optional four sets of two studs obtained by installing bus extension which is provided in all applicable lug kits.

Power Mod

Type WT Feed Thru Tap box: Knockout Diagrams

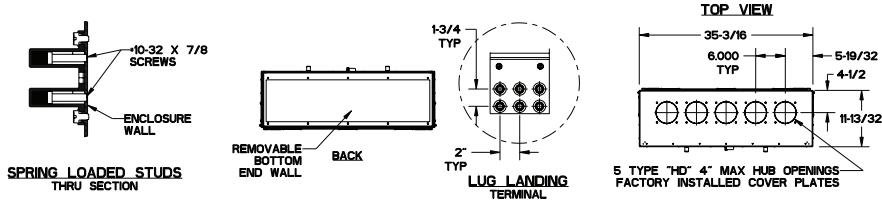
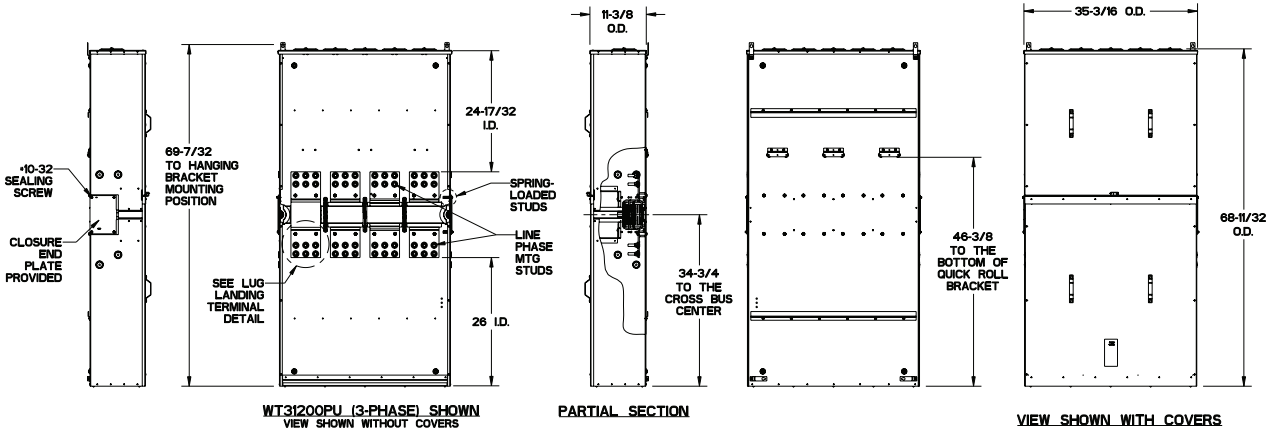

WP-1
WT11200PU
WT31200PU

WP-2	
WT11600PU	WT31600PU
WT12000PU	WT32000PU
WT12400PU	WT32400PU

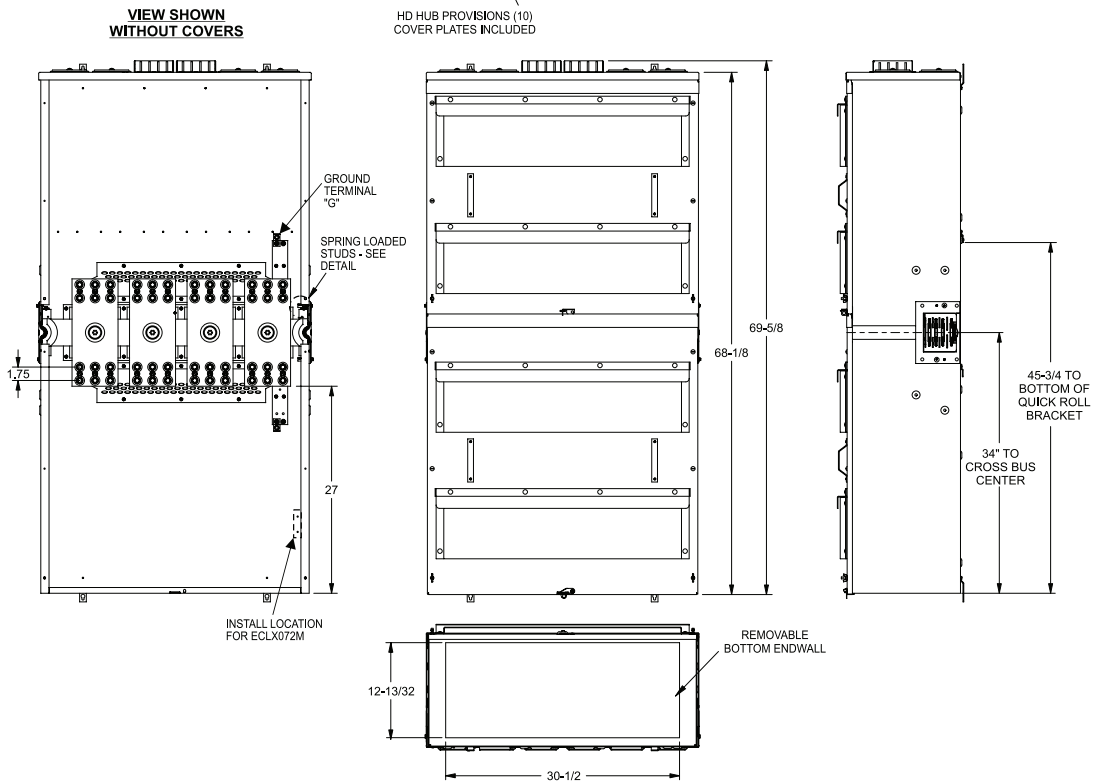
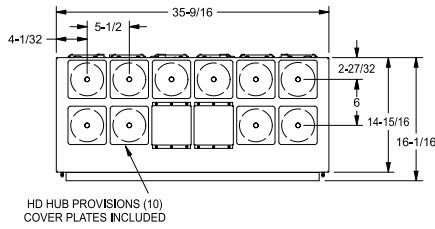

Power Mod

Type WMM Residential Meter Stacks

Residential Meter Stacks

Power Mod's core offering of Residential Meter Stacks, type WMM, offers the widest product offering and flexibility in the industry. Each meter stack houses the QuickSystem™ features to maximize productivity and minimize labor costs. To aid in productivity and labor cost reductions our 225 Amp meter stacks feature a new breaker - the "QS". The QS breaker adds to the Siemens exclusive feature set on our new 225 Amp Residential Meter Stacks.

3
METER
CENTERS

Benefits of the "QS" include:

- An exclusive 6 high 225 Amp meter stack at the same height as our 125 Amp meter stack - 225 to 125 conversion: No conversion kit needed.
- Single right hand bend wiring - saves time and wire
- 100K AIC offered from 100 up to 225 Amps

Siemens Residential Meter Stacks are packed with features inside and out: our exclusive knock out plate offers flexibility when pulling wires to the stack, new breaker supports keep breakers level and straight, moveable neutrals and grounds to save wire, and all of the QuickSystem features all designed with the contractor in mind.

Residential Meter Stacks quick reference

- 2-6 gang
- 125/225 Amp per position
- 1200 Amp horizontal bus rating
- UL standard 67
- UL file no. E27100
- AIC rating (100k)
- Voltage:
 - Single phase 120/240V AC max.
 - Three phase in single phase out
 - 120/208V AC max.
 - 240/120V AC max.
- All swing latches and rivets are stainless steel.
- Outdoor= NEMA 3R rated
- Indoor= NEMA 1R rated
- G90 galvanized steel
- ANSI 61 paint
- Ring type units comply with EUSERC drawing number 353

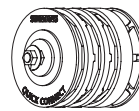

QuickConnect™
Included

Power Mod

Type WMM Residential Meter Stacks – 1 phase 4J

- 2-6 gang
- 125/225 Amp per position
- 1200 Amp horizontal bus rating



Residential 4-jaw ring type meter stacks: 1-phase, 3-wire SN, incoming and outgoing^{③ ④}

Outdoor catalog number	Indoor catalog number	Meter positions per stack	Breaker provision	Maximum AIC ^⑤	Dimensions (inches) ^①			Knockout diagram
					Height	Width	Depth	
Max. tenant breaker (Amps): 125								
WMM21125	MM21125	2 Position	QP, QPH, HQP, HQPH, MP-T, MP-HT, MP-MT	100k	34.31	13.09	8.09	KA-12
WMM31125	MM31125	3 Position		100k	43.31	13.09	8.09	KA-13
WMM41125	MM41125	4 Position		100k	52.31	13.09	8.09	KA-14
WMM51125	MM51125	5 Position		100k	61.31	13.09	8.09	KA-15
WMM61125	MM61125	6 Position		100k	70.31	13.09	8.09	KA-16
Max. tenant breaker (Amps): 225^{② ⑥}								
WMM21225	MM21225	2 Position	QS, QSH, QSHH, HQS, HQSH, QP, QPH, HQP, HQPH, MP-T, MP-HT, MP-MT	100k	34.31	16.22	8.09	KA-22
WMM31225	MM31225	3 Position		100k	43.31	16.22	8.09	KA-23
WMM41225	MM41225	4 Position		100k	52.31	16.22	8.09	KA-24
WMM51225	MM51225	5 Position		100k	61.31	16.22	8.09	KA-25
WMM61225	MM61225	6 Position		100k	70.31	16.22	8.09	KA-26

Residential 4-jaw ringless type meter stacks: 1-phase, 3-wire SN, incoming and outgoing^{③ ④}

Outdoor catalog number (no bypass)	Outdoor catalog number (horn bypass)	Indoor catalog number (no bypass)	Indoor catalog number (horn bypass)	Meter positions per stack	Breaker provision	Max. AIC ^⑤	Dimensions (inches) ^①			Knockout diagram
							Height	Width	Depth	
Max. tenant breaker (Amps): 125										
WMM21125R	WMM21125RB	MM21125R	MM21125RB	2 Position	QP, QPH, HQP, HQPH, MP-T, MP-HT, MP-MT	100k	34.31	13.09	8.09	KA-12
WMM31125R	WMM31125RB	MM31125R	MM31125RB	3 Position		100k	43.31	13.09	8.09	KA-13
WMM41125R	WMM41125RB	MM41125R	MM41125RB	4 Position		100k	52.31	13.09	8.09	KA-14
WMM51125R	WMM51125RB	MM51125R	MM51125RB	5 Position		100k	61.31	13.09	8.09	KA-15
WMM61125R	WMM61125RB	MM61125R	MM61125RB	6 Position		100k	70.31	13.09	8.09	KA-16
Max. tenant breaker (Amps): 225^{② ⑥}										
WMM21225R	WMM21225RB	MM21225R	MM21225RB	2 Position	QS, QSH, QSHH, HQS, HQSH, QP, QPH, HQP, HQPH, MP-T, MP-HT, MP-MT	100k	34.31	16.22	8.09	KA-22
WMM31225R	WMM31225RB	MM31225R	MM31225RB	3 Position		100k	43.31	16.22	8.09	KA-23
WMM41225R	WMM41225RB	MM41225R	MM41225RB	4 Position		100k	52.31	16.22	8.09	KA-24
WMM51225R	WMM51225RB	MM51225R	MM51225RB	5 Position		100k	61.31	16.22	8.09	KA-25
WMM61225R	WMM61225RB	MM61225R	MM61225RB	6 Position		100k	70.31	16.22	8.09	KA-26

① Dimensions shown are representative of outside box dimensions and do not include allowances for mounting bumps, endwalls, covers, hubs, or hardware protrusions. Dimensions are subject to change.

② 225A available in lower three positions only. 200A continuous for all other positions.

③ NOT for use on 3-phase, 4-wire delta systems.

④ Field installable 5th jaw (ECMF5). Fifth jaw can be isolated if needed (ECMF5i).

⑤ Max AIC determined by maximum AIC of tenant breakers. Higher ratings may be achieved through approved series rating combinations.

⑥ Install QP breakers below QS breakers.

Power Mod

Type WMM Residential Meter Stacks – 1 phase 5J

- 2-6 gang
- 125/225 Amp per position
- 1200 Amp horizontal bus rating



Residential 5-jaw ring type meter stacks: 1-phase, 3-wire SN, incoming and outgoing^{③④}

Outdoor catalog number	Indoor catalog number	Meter positions per stack	Breaker provision	Maximum AIC ^⑤	Dimensions (inches) ^①			Knockout diagram
					Height	Width	Depth	
Max. tenant breaker (Amps): 125								
WMM21125J	MM21125J	2 Position	QP, QPH, HQP, HQPH, MP-T, MP-HT, MP-MT	100k	34.31	13.09	8.09	KA-12
WMM31125J	MM31125J	3 Position		100k	43.31	13.09	8.09	KA-13
WMM41125J	MM41125J	4 Position		100k	52.31	13.09	8.09	KA-14
WMM51125J	MM51125J	5 Position		100k	61.31	13.09	8.09	KA-15
WMM61125J	MM61125J	6 Position		100k	70.31	13.09	8.09	KA-16
Max. tenant breaker (Amps): 225^{②④}								
WMM21225J	MM21225J	2 Position	QS, QSH, QSHH, HQS, HQSH, QP, QPH, HQP, HQPH, MP-T, MP-HT, MP-MT	100k	34.31	16.22	8.09	KA-22
WMM31225J	MM31225J	3 Position		100k	43.31	16.22	8.09	KA-23
WMM41225J	MM41225J	4 Position		100k	52.31	16.22	8.09	KA-24
WMM51225J	MM51225J	5 Position		100k	61.31	16.22	8.09	KA-25
WMM61225J	MM61225J	6 Position		100k	70.31	16.22	8.09	KA-26

Residential 5-jaw ringless type meter stacks: 1-phase, 3-wire SN, incoming and outgoing^{③④}

Outdoor catalog number (no bypass)	Outdoor catalog number (horn bypass)	Indoor catalog number (no bypass)	Indoor catalog number (horn bypass)	Meter positions per stack	Breaker provision	Max. AIC ^⑤	Dimensions (inches) ^①			Knockout diagram
							Height	Width	Depth	
Max. tenant breaker (Amps): 125										
WMM21125RJ	WMM21125RJB	MM21125RJ	MM21125RJB	2 Position	QP, QPH, HQP, HQPH, MP-T, MP-HT, MP-MT	100k	34.31	13.09	8.09	KA-12
WMM31125RJ	WMM31125RJB	MM31125RJ	MM31125RJB	3 Position		100k	43.31	13.09	8.09	KA-13
WMM41125RJ	WMM41125RJB	MM41125RJ	MM41125RJB	4 Position		100k	52.31	13.09	8.09	KA-14
WMM51125RJ	WMM51125RJB	MM51125RJ	MM51125RJB	5 Position		100k	61.31	13.09	8.09	KA-15
WMM61125RJ	WMM61125RJB	MM61125RJ	MM61125RJB	6 Position		100k	70.31	13.09	8.09	KA-16
Max. tenant breaker (Amps): 225^{②④}										
WMM21225RJ	WMM21225RJB	MM21225RJ	MM21225RJB	2 Position	QS, QSH, QSHH, HQS, HQSH, QP, QPH, HQP, HQPH, MP-T, MP-HT, MP-MT	100k	34.31	16.22	8.09	KA-22
WMM31225RJ	WMM31225RJB	MM31225RJ	MM31225RJB	3 Position		100k	43.31	16.22	8.09	KA-23
WMM41225RJ	WMM41225RJB	MM41225RJ	MM41225RJB	4 Position		100k	52.31	16.22	8.09	KA-24
WMM51225RJ	WMM51225RJB	MM51225RJ	MM51225RJB	5 Position		100k	61.31	16.22	8.09	KA-25
WMM61225RJ	WMM61225RJB	MM61225RJ	MM61225RJB	6 Position		100k	70.31	16.22	8.09	KA-26

① Dimensions shown are representative of outside box dimensions and do not include allowances for mounting bumps, endwalls, covers, hubs, or hardware protrusions. Dimensions are subject to change.

② 225A available in lower three positions only. 200A continuous for all other positions.

③ NOT for use on 3-phase, 4-wire delta systems.

④ Field installable 5th jaw (ECMF5). Fifth jaw can be isolated if needed (ECMF5i).

⑤ Max AIC determined by maximum AIC of tenant breakers. Higher ratings may be achieved through approved series rating combinations.

⑥ Install QP breakers below QS breakers.

Power Mod

Type WMM Residential Meter Stacks – 3 phase in 1 phase out 5J

- 2-6 gang
- 125/225 Amp per position
- 1200 Amp horizontal bus rating



Residential 5-jaw ring type meter stacks: 3-phase, 4-wire SN, incoming and 1-phase, 3 wire SN outgoing^{③④⑦}

Outdoor catalog number	Indoor catalog number	Meter positions per stack	Breaker provision	Maximum AIC ^⑤	Dimensions (inches) ^①			Knockout diagram
					Height	Width	Depth	
Max. tenant breaker (Amps): 125								
WMM22125J	MM22125J	2 Position	QP, QPH, HQP, HQPH, MP-T, MP-HT, MP-MT	100k	34.31	13.09	8.09	KA-12
WMM32125J	MM32125J	3 Position		100k	43.31	13.09	8.09	KA-13
WMM42125J	MM42125J	4 Position		100k	52.31	13.09	8.09	KA-14
WMM52125J	MM52125J	5 Position		100k	61.31	13.09	8.09	KA-15
WMM62125J	MM62125J	6 Position		100k	70.31	13.09	8.09	KA-16
Max. tenant breaker (Amps): 225^{②④}								
WMM22225J	MM22225J	2 Position	QS, QSH, QSHH, HQS, HQSH, QP, QPH, HQP, HQPH, MP-T, MP-HT, MP-MT	100k	34.31	16.22	8.09	KA-22
WMM32225J	MM32225J	3 Position		100k	43.31	16.22	8.09	KA-23
WMM42225J	MM42225J	4 Position		100k	52.31	16.22	8.09	KA-24
WMM52225J	MM52225J	5 Position		100k	61.31	16.22	8.09	KA-25
WMM62225J	MM62225J	6 Position		100k	70.31	16.22	8.09	KA-26

Residential 5-jaw ringless type meter stacks: 3-phase, 4-wire SN, incoming and 1-phase, 3 wire SN outgoing^{③④⑦}

Outdoor catalog number (no bypass)	Outdoor catalog number (horn Bypass)	Indoor catalog number (no bypass)	Indoor catalog number (horn bypass)	Meter positions per stack	Breaker provision	Max. AIC ^⑤	Dimensions (inches) ^①			Knockout diagram
							Height	Width	Depth	
Max. tenant breaker (Amps): 125										
WMM22125RJ	WMM22125RJB	MM22125RJ	MM22125RJB	2 Position	QP, QPH, HQP, HQPH, MP-T, MP-HT, MP-MT	100k	34.31	13.09	8.09	KA-12
WMM32125RJ	WMM32125RJB	MM32125RJ	MM32125RJB	3 Position		100k	43.31	13.09	8.09	KA-13
WMM42125RJ	WMM42125RJB	MM42125RJ	MM42125RJB	4 Position		100k	52.31	13.09	8.09	KA-14
WMM52125RJ	WMM52125RJB	MM52125RJ	MM52125RJB	5 Position		100k	61.31	13.09	8.09	KA-15
WMM62125RJ	WMM62125RJB	MM62125RJ	MM62125RJB	6 Position		100k	70.31	13.09	8.09	KA-16
Max. tenant breaker (Amps): 225^{②④}										
WMM22225RJ	WMM22225RJB	MM22225RJ	MM22225RJB	2 Position	QS, QSH, QSHH, HQS, HQSH, QP, QPH, HQP, HQPH, MP-T, MP-HT, MP-MT	100k	34.31	16.22	8.09	KA-22
WMM32225RJ	WMM32225RJB	MM32225RJ	MM32225RJB	3 Position		100k	43.31	16.22	8.09	KA-23
WMM42225RJ	WMM42225RJB	MM42225RJ	MM42225RJB	4 Position		100k	52.31	16.22	8.09	KA-24
WMM52225RJ	WMM52225RJB	MM52225RJ	MM52225RJB	5 Position		100k	61.31	16.22	8.09	KA-25
WMM62225RJ	WMM62225RJB	MM62225RJ	MM62225RJB	6 Position		100k	70.31	16.22	8.09	KA-26

① Dimensions shown are representative of outside box dimensions and do not include allowances for mounting bumps, endwalls, covers, hubs, or hardware protrusions. Dimensions are subject to change.
 ② 225A available in lower three positions only. 200A continuous for all other positions.

③ Approved for use on 3-phase, 4-wire delta systems. Must field phase away from B phase (A and C phase only).
 ④ 5th jaw can be isolated if needed (ECMF5).

⑤ Max AIC determined by maximum AIC of tenant breakers. Higher ratings may be achieved through approved series rating combinations.
 ⑥ Install QP breakers below QS breakers.
 ⑦ Stacks come factory phased as AB, BC, AC... top to bottom

Power Mod

Type WMM Residential Meter Stacks: Knockout Diagrams

3
METER
CENTERS

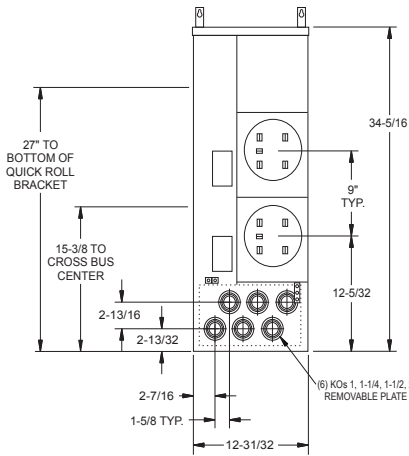

KA-12	
WMM21125XX	MM21125XX
WMM22125XXX	MM22125XXX

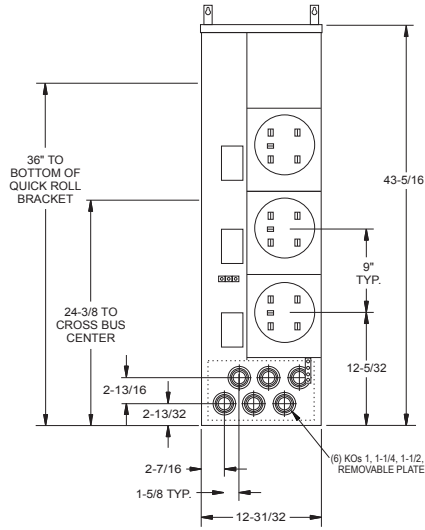

KA-13	
WMM31125XX	MM31125XX
WMM32125XXX	MM32125XXX

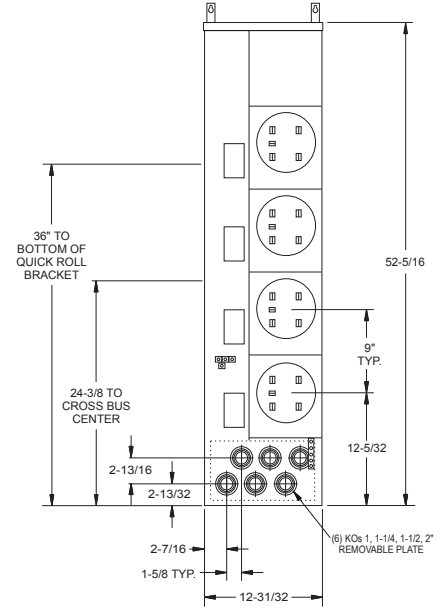

KA-14	
WMM41125XX	MM41125XX
WMM42125XXX	MM42125XXX

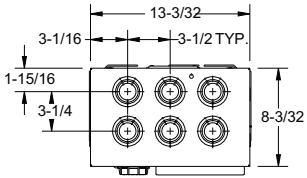

125 Amp Typical Top View for NEMA 1

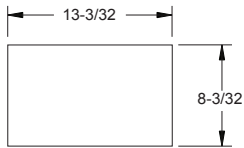

125 Amp Typical Top View NEMA 3R

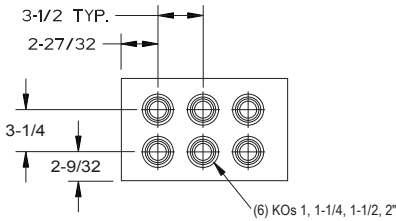

125 Amp Typical Bottom View

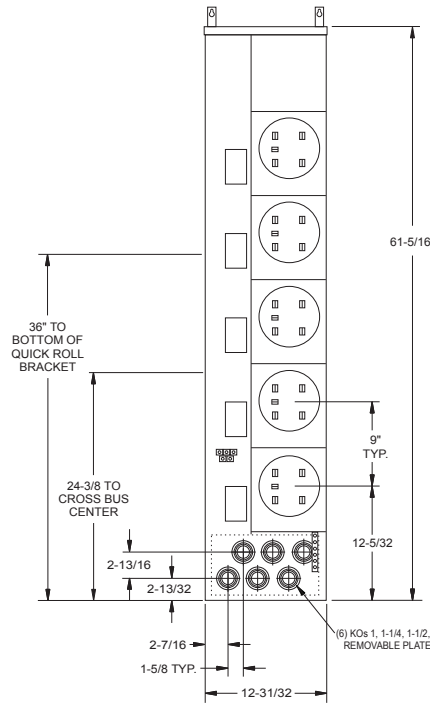

KA-15	
WMM51125XX	MM51125XX
WMM52125XXX	MM52125XXX

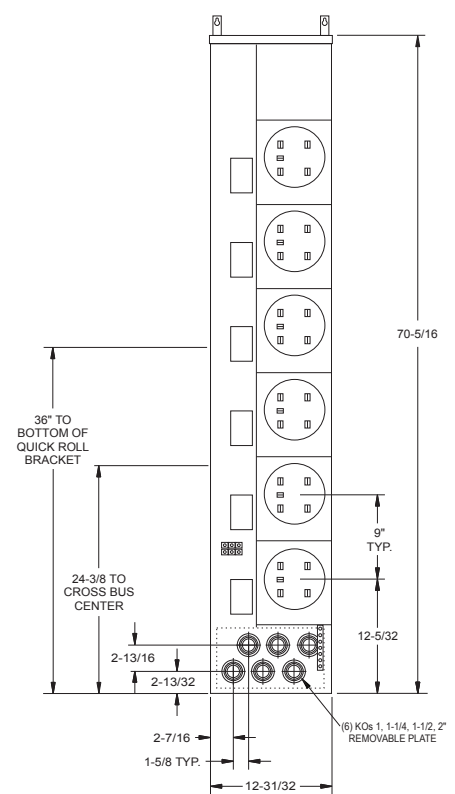

KA-16	
WMM61125XX	MM61125XX
WMM62125XXX	MM62125XXX

Power Mod

Type WMM Residential Meter Stacks: Knockout Diagrams

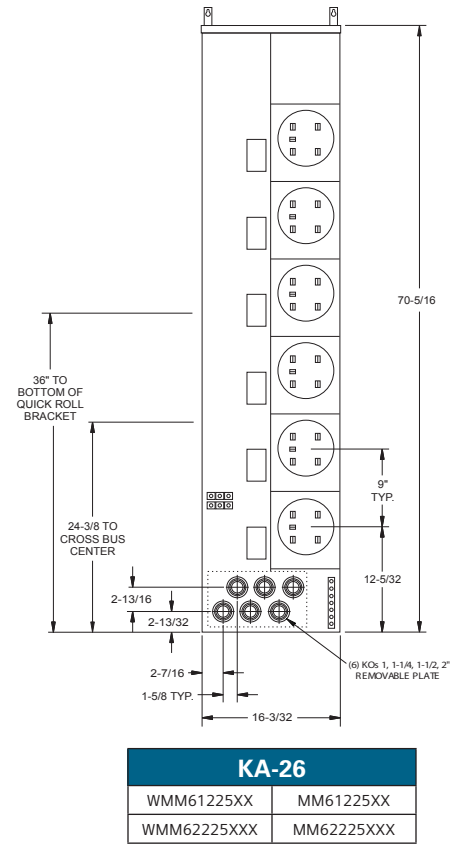
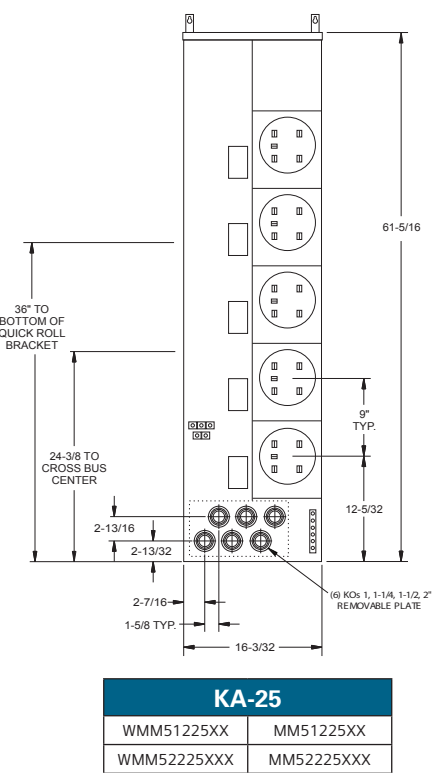
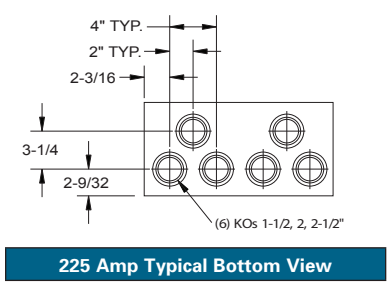
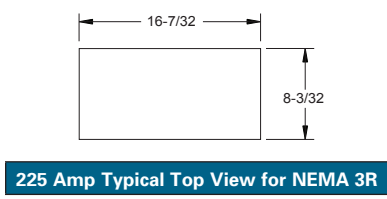
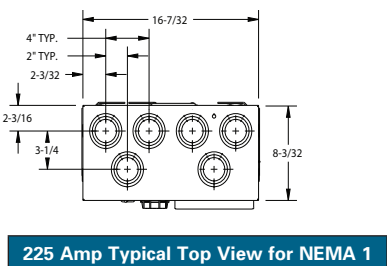
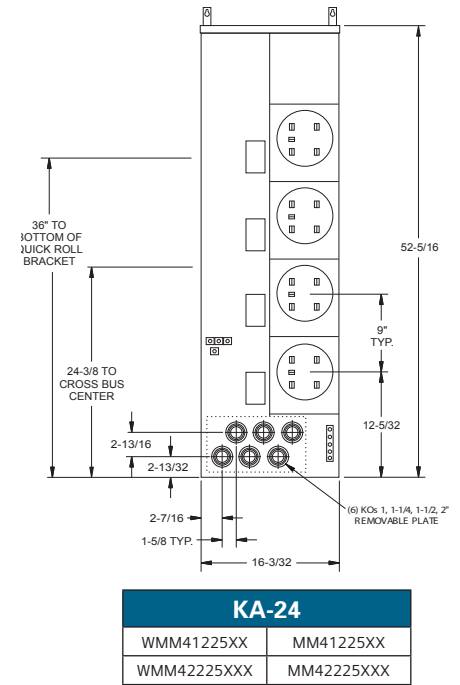
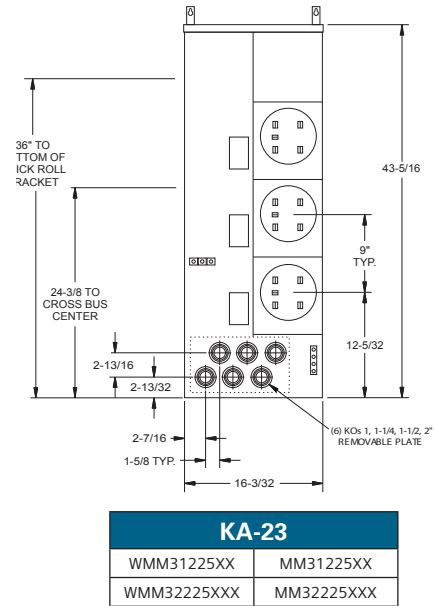
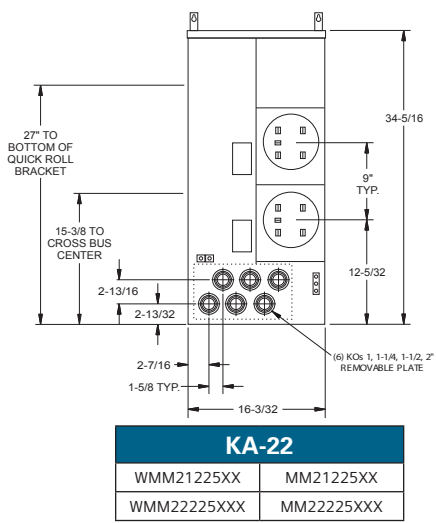

Power Mod

Type WML Lever Bypass Meter Stacks

Lever Bypass Meter Stacks

Lever Bypass meter stacks (type WML) are designed to meet the requirements of those utilities specifying lever bypass meter sockets for residential and commercial applications.

Features include:

- QuickSystem™ features^①
- High-quality, time-proven Talon HQ sockets
- A line of 3-phase 100 Amp meter stacks to minimize tenant main cost
- Removable back knockout plate to facilitate wiring
- 225 Amp capability in single and three phase designs
- Up to 4 positions with 225 Amp tenant mains, up to 2 positions with 400 Amp tenant mains
- All lever bypass stacks are ringless.

Lever Bypass quick reference

- 125A 2-6 position
- 100A/225A 1-4 position
- 400A 1-2 position
- 1200A horizontal bus rating
- UL Standard # UL67
- UL file # E27100
- AIC rating (25K, 35K, 65k and 100K)
- Voltage
 - Single phase 120/240V AC max
 - Three in single phase out 208Y/120V AC
 - Three Phase 240V AC max
- All swing latches and rivets are stainless steel.
- Indoor = NEMA 1 rated
- Outdoor = NEMA 3R rated
- G90 galvanized steel
- ANSI 61 paint

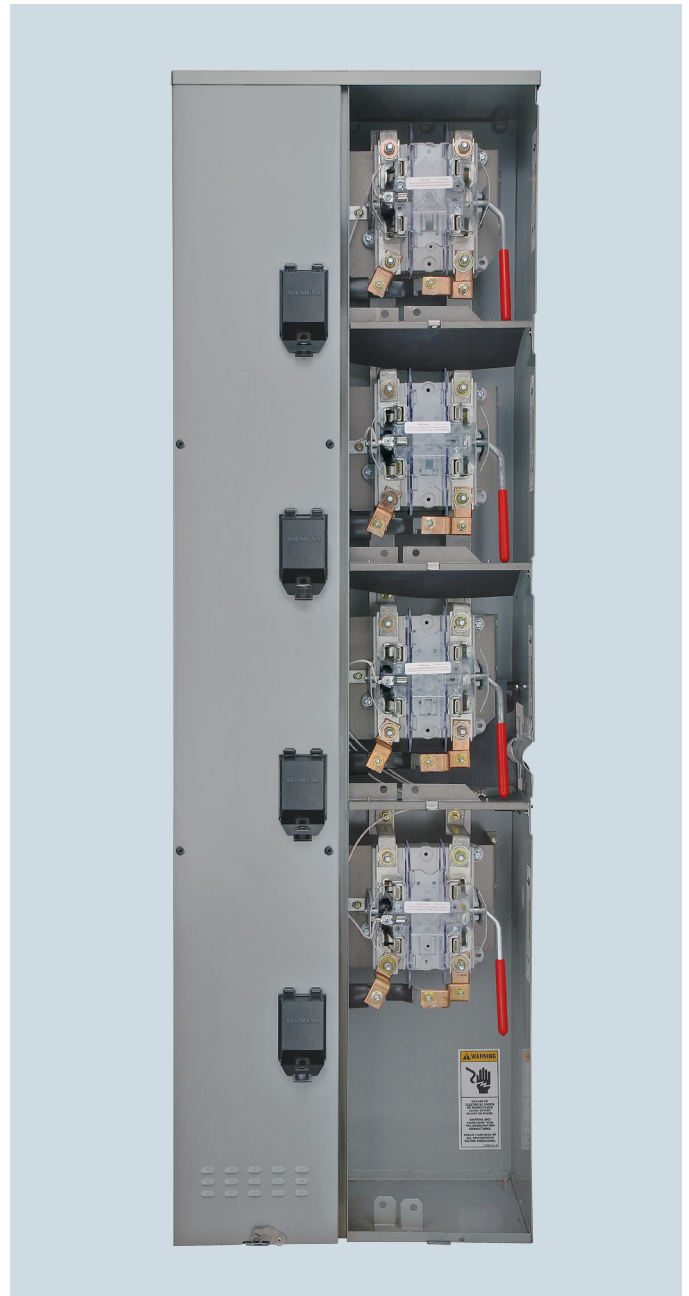

**QuickConnect™
Included**

^① QuickPhase™ is not applicable with non-field phaseable stacks (WML, 225A-400A, 3-phase-in/3-phase-out).

Power Mod

Type WML Lever Bypass Meter Stacks

- 125A 2-6 position
- 1200A horizontal bus rating



Commercial Ringless Type Meter Stacks: Lever Bypass 1-Phase, 3-Wire SN, Incoming and Outgoing, Lever Bypass, 5-Jaw Sockets^{②④}

Outdoor Catalog Number	Indoor Catalog Number	Meter Positions Per Stack	Breaker Provisions	Maximum AIC ^③	Dimensions (inches) ^①			Stack Phasing Phases/Sockets
					Height	Width	Depth	
Max. tenant breaker (Amps): 125								
WML21125RJ	ML21125RJ	2	QP, QPH, HQP, HQPH, MP-T, MP-HT, MP-MT	100k	36.18	14.48	11.51	—
WML31125RJ	ML31125RJ	3		100k	46.18	14.48	11.51	—
WML41125RJ	ML41125RJ	4		100k	56.18	14.48	11.51	—
WML51125RJ	ML51125RJ	5		100k	66.18	14.48	11.51	—
WML61125RJ	ML61125RJ	6		100k	76.18	14.48	11.51	—

3-Phase, 4-Wire SN, Incoming and 1-Phase, 3-Wire SN Outgoing, Lever Bypass, 5-Jaw Sockets^{②④}

Outdoor Catalog Number	Indoor Catalog Number	Meter Positions Per Stack	Breaker Provisions	Maximum AIC ^③	Dimensions (inches) ^①			Stack Phasing Phases/Sockets
					Height	Width	Depth	
Max. tenant breaker (Amps): 125								
WML22125RJ	ML22125RJ	2	QP, QPH, HQP, HQPH, MP-T, MP-HT, MP-MT	100k	36.18	14.48	11.51	—
WML32125RJ	ML32125RJ	3		100k	46.18	14.48	11.51	—
WML42125RJ	ML42125RJ	4		100k	56.18	14.48	11.51	—
WML52125RJ	ML52125RJ	5		100k	66.18	14.48	11.51	—
WML62125RJ	ML62125RJ	6		100k	76.18	14.48	11.51	—

① Dimensions shown are representative of outside box dimensions and do not include allowances for mounting bumps, hubs, or hardware protrusions.
 ② Not for use on 3-phase, 4-wire delta systems.

③ Max AIC determined by maximum AIC of tenant breakers when used in conjunction with a meter socket. Higher overall ratings may be achieved through approved series rating combinations.

④ Stacks are field phaseable.

Power Mod

Type WML Lever Bypass Meter Stacks

- 225A 1-4 position
- 1200A horizontal bus rating

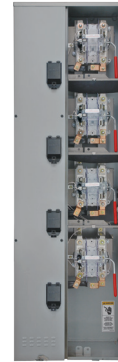

Commercial Ringless Type Meter Stacks: Lever Bypass 1-Phase, 3-Wire SN, Incoming and Outgoing, Lever Bypass, 5-Jaw Sockets^{②④}

Outdoor Catalog Number	Indoor Catalog Number	Meter Positions Per Stack	Breaker Provisions	Maximum AIC ^③	Dimensions (inches) ^①			Stack phasing phases/sockets
					Height	Width	Depth	
Max. tenant breaker (Amps): 225								
WML11225RJ	ML11225RJ	1	QS, QSH, QSHH, HQS, HQSH, QP, QPH, HQP, HQPH, MP-T, MP-HT, MP-MT	100k	27.75	19.50	9.00	—
WML21225RJ	ML21225RJ	2		100k	40.75	19.50	9.00	—
WML31225RJ	ML31225RJ	3		100k	49.75	19.50	9.00	—
WML41225RJ	ML41225RJ	4		100k	62.75	19.50	9.00	—

3-Phase, 4-Wire SN, Incoming and 1-Phase, 3-Wire SN Outgoing, Lever Bypass, 5-Jaw Sockets^{②⑤}

Outdoor Catalog Number	Indoor Catalog Number	Meter Positions Per Stack	Breaker Provisions	Maximum AIC ^③	Dimensions (inches) ^①			Stack phasing phases/sockets
					Height	Width	Depth	
Max. tenant breaker (Amps): 225								
WML12225RJ	ML12225RJ	1	QS, QSH, QSHH, HQS, HQSH, QP, QPH, HQP, HQPH, MP-T, MP-HT, MP-MT	100k	27.75	19.50	9.00	1-AB
WML22AB225RJ	ML22AB225RJ	2		100k	40.75	19.50	9.00	1-AC, 1-BC
WML22BC225RJ	ML22BC225RJ	2		100k	40.75	19.50	9.00	1-AC, 1-AB
WML22CA225RJ	ML22CA225RJ	2		100k	40.75	19.50	9.00	1-AB, 1-BC
WML32225RJ	ML32225RJ	3		100k	49.75	19.50	9.00	1-AB, 1-BC, 1-CA
WML42AB225RJ	ML42AB225RJ	4		100k	62.75	19.50	9.00	2-AB, 1-BC, 1-CA
WML42BC225RJ	ML42BC225RJ	4		100k	62.75	19.50	9.00	1-AB, 2-BC, 1-CA
WML42CA225RJ	ML42CA225RJ	4		100k	62.75	19.50	9.00	1-AB, 1-BC, 2-CA

① Dimensions shown are representative of outside box dimensions and do not include allowances for mounting bumps, hubs, or hardware protrusions.

② Not for use on 3-phase, 4-wire delta systems.

③ Max AIC determined by maximum AIC of tenant breakers when used in conjunction with a meter socket. Higher overall ratings may be achieved through approved series rating combinations.

④ Are field phaseable.
⑤ Not field phaseable.

Power Mod

Type WML Lever Bypass Meter Stacks

- 100A/125A
1-4 position
- 1200A horizontal
bus rating



Commercial Ringless Type Meter Stacks: Lever Bypass 3-Phase, 4-Wire SN, Incoming And Outgoing, Lever Bypass, 7-Jaw Sockets^⑤

Outdoor Catalog Number	Indoor Catalog Number	Meter Positions Per Stack	Breaker Provisions	Maximum AIC ^③	Dimensions (inches) ^①		
					Height	Width	Depth
Max. tenant breaker (Amps)^② : 100							
WML13100RJ	ML13100RJ	1	QP, MP-T, QPH, MP-HT, HQP, MP-MT	65k	27.75	23.50	9.00
WML23100RJ	ML23100RJ	2		65k	40.75	23.50	9.00
WML33100RJ	ML33100RJ	3		65k	49.75	23.50	9.00
WML43100RJ	ML43100RJ	4		65k	62.75	23.50	9.00
Max. tenant breaker (Amps)^② : 225							
WML13225RJ	ML13225RJ	1	QR2, QRH2, MQ, MQH, MQL, HQR2, HQR2H	100k	27.75	23.50	9.00
WML23225RJ	ML23225RJ	2		100k	40.75	23.50	9.00
WML33225RJ	ML33225RJ	3		100k	49.75	23.50	9.00
WML43225RJ	ML43225RJ	4		100k	62.75	23.50	9.00

① Dimensions shown are representative of outside box dimensions and do not include allowances for mounting bumps, hubs, or hardware protrusions.
② 3-pole breakers only.

③ Max AIC determined by maximum AIC of tenant breakers when used in conjunction with a meter socket. Higher overall ratings may be achieved through approved series rating combinations.

④ Rated for use with 240/120V Delta systems.

Power Mod

Type WML Lever Bypass Meter Stacks

3
METER
CENTERS

- 400A 1-2 position
- 1200A horizontal bus rating
- 25-35KAIC



Commercial Ringless Type Meter Stacks: Lever Bypass

Outdoor Catalog Number	Meter Positions Per Stack	Breaker Provisions	Maximum AIC	Dimensions (inches) ^①			Socket Phasing	Stack Phasing
				Height	Width	Depth		

1-Phase, 3-Wire SN, Incoming and Outgoing, Lever Bypass, 5-Jaw Sockets^②

Max. tenant breaker (Amps): 400								
WML11400RJ ^③	1	JXD62B400	25k	44.00	16.31	9.69	—	—
WML21400RJ ^③	2	Factory installed	25k	70.38	23.00	9.69	—	—

3-Phase, 4-Wire SN, Incoming and 1-Phase, 3-Wire SN Outgoing, Lever Bypass, 5-Jaw Sockets^{②④}

Max. tenant breaker (Amps): 400								
WML12400RJ ^③	1	JXD62B400	25k	44.00	16.31	9.69	1-AB	—
WML22400RJ ^③	2	Factory installed	25k	70.38	23.00	9.69	1-AB, 1-BC	—

3-Phase, 4-Wire SN, Incoming and Outgoing, Lever Bypass, 7-Jaw Sockets^②

Max. tenant breaker (Amps) ^⑤ : 400								
WML13400RJ ^③	1	JXD63B400	25k	44.00	16.31	9.69	—	—
WML23400RJ ^③	2	Factory installed	25k	70.38	23.00	9.69	—	—

Commercial Ringless Type Meter Stacks: Lever Bypass

Max. tenant breaker (Amps) ^⑤ : 400								
WML11400RJH	1	CJD6-A	35k	51.06	16.34	9.75	—	1 Ph in / 1 Ph out
WML12400RJH	1		35k	51.06	16.34	9.75	—	3 Ph in / 1 Ph out
WML13400RJH	1		35k	51.06	16.34	9.75	—	3 Ph in / 3 Ph out

Alternate Amperage Breakers For 1 Position Stacks

Add Suffix ➤	Suffix	Breaker Amperage
	T1	200A
	T19	225A
	T2	250A
	T3	300A
T4	350A	

Alternate Amperage Breakers For 2 Position Stacks

Add Suffix ➤	Suffix	Breaker Amperage	Suffix	Breaker Amperage
	T5	200A/200A	T15	300A/400A
	T6	200A/250A	T16	350A/350A
	T7	200/300A	T17	350A/400A
	T8	200/350A	T18	250A/250A
	T9	200/400A	T20	200A/225A
	T10	250A/300A	T21	225A/225A
	T11	250A/350A	T22	225A/250A
	T12	250A/400A	T23	225A/300A
	T13	300A/300A	T24	225A/350A
	T14	300A/350A	T25	225A/400A

- ① Dimensions shown are representative of outside box dimensions and do not include allowances for mounting bumps, hubs, or hardware protrusions.
- ② Not for use on 3-phase, 4-wire delta systems.
- ③ Alternate amperage breakers are available. Please see tables on left for suffix that needs to be added. Additional lead time may apply. Contact sales office for details.
- ④ Not field phaseable.
- ⑤ 3-pole breakers only

Power Mod

Type WML Lever Bypass Meter Stacks

Fusible Switch Lever Bypass Meter Stacks

Fusible Switch Lever Bypass Meter stacks This Commercial Lever Bypass meter stacks (type WML) feature a 400 Amp - class T - fusible pull out assembly..

Features include:

- QuickSystem™ features
- High-quality, time proven Talon HQ sockets
- Removable back knockout plate to facilitate wiring
- Available in single and three phases designs
- Single position with 400amp tenant main
- All lever bypass stacks are ringless.

Lever Bypass With Fusible Switch Quick Reference:

- 400A 1 position
- 1200A horizontal bus rating
- UL Standard #UL67
- UL file #E27100
- AIC rating 100KAIC
- Voltage
 - Single phase 120/240V AC Max
 - Three phase in, single phase out 208Y/120V AC
 - Three Phase 240V AC Max
- All swing latches and rivets are stainless steel
- Outdoor = NEMA 3R rated
- Indoor = NEMA 1 rated
- G90 galvanized steel
- ANSI 61 paint

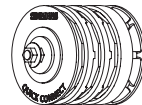

QuickConnect™
Included

Power Mod

Type WML Lever Bypass Meter Stacks

- 400A 1 position
- 1200A horizontal bus rating
- 400A Class T fuse (not included)



Fusible Switch Lever Bypass Ringless Meter Stacks

Outdoor Catalog Number	Indoor Catalog Number	Meter Positions Per Stack	Breaker Provisions	Maximum AIC	Dimensions (inches) ^①		
					Height	Width	Depth
Max. Tenant Fuse (Amps): 400							

Single-Phase In/Out

WML11400RJFS	ML11400RJFS	1	Class T fuse	100K	38.31	16.34	11.22
--------------	-------------	---	--------------	------	-------	-------	-------

Three-Phase In/ Single-Phase Out

WML12400RJFS	ML12400RJFS	1	Class T fuse	100K	38.31	16.34	11.22
--------------	-------------	---	--------------	------	-------	-------	-------

Three-Phase In/Out

WML13400RJFS	ML13400RJFS	1	Class T fuse	100K	38.31	16.34	11.22
--------------	-------------	---	--------------	------	-------	-------	-------

^① Dimensions shown are representative of the outside box dimensions and do not include allowances for mounting bumps, hubs, or hardware protrusions.



Power Mod

Meter Stacks: WML Lever Bypass Stacks Knockout Diagrams

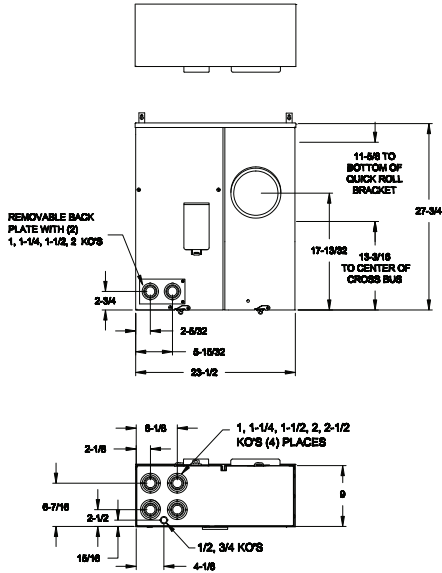

L-7	
WML13100RJ	ML13100RJ

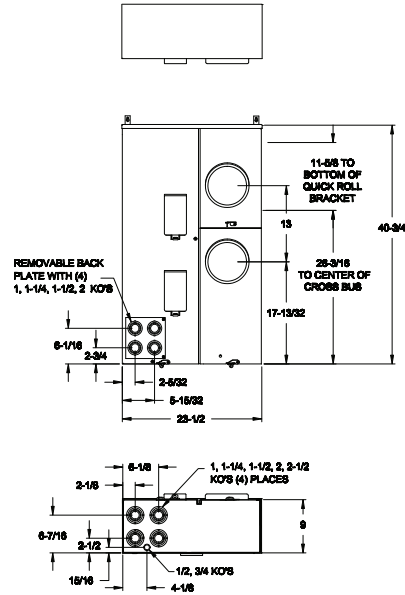

L-8	
WML23100RJ	ML23100RJ

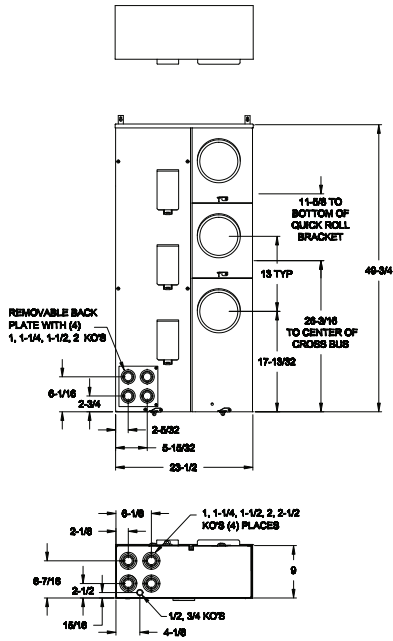

L-9	
WML33100RJ	ML33100RJ

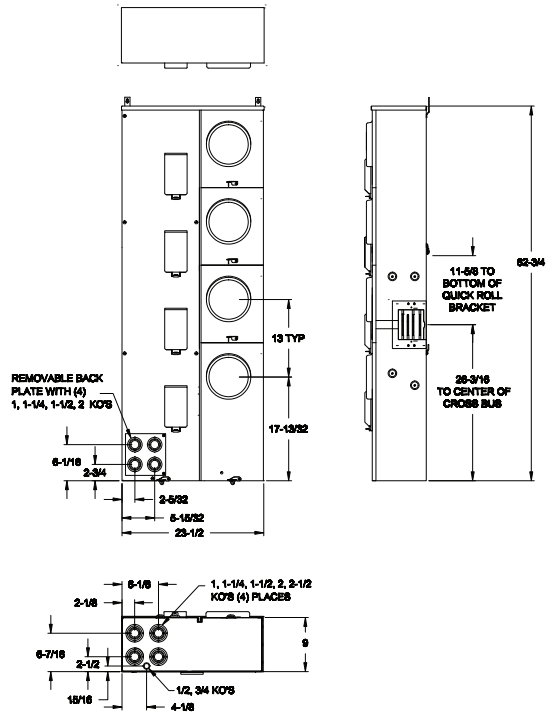

L-10	
WML43100RJ	ML43100RJ

Power Mod

Type WMLZF and WMLZ Utility Meter Stacks: Knockout Diagrams

Fusible Switch Lever Bypass Meter Stacks

The WMLZ and WMLZF lever bypass meter stacks are designed to allow the use of class T (400amp max) fuses ahead of all meter positions where the local serving utility may require it. WMLZF stacks feature a 400amp fusible pull out assembly which connects to a secondary 400amp horizontal bus that can feed downstream meter stacks. The WMLZ stacks include the secondary 400amp horizontal bus that can connect from the WMLZF meter stacks. The standard Power Mod 1200amp horizontal bus "passes thru" to feed downstream modules - the meter sockets in WMLZ and WMLZF do NOT connect directly to the 1200amp horizontal bus - only to the 400amp horizontal bus.

Features include:

- QuickSystem™ features
- High-quality, time-proven Talon HQ sockets
- 125 Amp capability for 3-phase in/single-phase out
- 3 to 6 positions in both the fused stack and the expansion stack
- 400 Amp class T fusible-pullout in WMLZF stacks
- Secondary 400 amp horizontal bus to supply power to down stream sockets

Xcel Residential Lever Bypass Quick Reference:

- 125A 3 – 6 position
- 1200A horizontal bus rating
- 400A secondary horizontal bus rating and vertical bus rating
- UL Standard # UL67
- UL file #E27100
- AIC rating (100K)
- Voltage -Three-phase in/ single-phase out 120/240V AC max
- All swing latches and rivets are stainless steel
- Outdoor = NEMA 3R rated
- Indoor = NEMA 1R rated
- G90 galvanized steel
- ANSI 61 paint



QuickConnect™
Included

Power Mod

Type WMLZF and WMLZ Utility Meter Stacks: Knockout Diagrams

- 125A 3 – 6 position
- 1200A horizontal bus
- 400A 2nd horizontal bus
- 400A vertical bus



Fused Residential Ringless Type Stacks: Lever Bypass 3-Phase, 4-Wire SN, Incoming and 1Phase, 3-Wire SN, Outgoing, Lever Bypass, 5-Jaw Sockets

Max. tenant breaker (Amps): 125							
Outdoor Catalog Number	Indoor Catalog Number	Meter Positions Per Stack	Breaker Provisions	Maximum AIC	Dimensions (inches)		
					Height	Width	Depth
WMLZF32125RJ	MLZF32125RJ	3	QP, MP-T, QPH, HQP, HQPH, MP-HT, MP-MT	100k	54.06	14.61	11.51
WMLZF42125RJ	MLZF42125RJ	4		100k	64.06	14.61	11.51
WMLZF52125RJ	MLZF52125RJ	5		100k	74.06	14.61	11.51
WMLZF62125RJ	MLZF62125RJ	6		100k	84.06	14.61	11.51

Non-Fused Residential Ringless Type Stacks: Lever Bypass 3-Phase, 4-Wire SN, Incoming and 1Phase, 3-Wire SN, Outgoing, Lever Bypass, 5-Jaw Sockets

Max. tenant breaker (Amps): 125							
Outdoor Catalog Number	Indoor Catalog Number	Meter Positions Per Stack	Breaker Provisions	Maximum AIC	Dimensions (inches)		
					Height	Width	Depth
WMLZ32125RJ	MLZ32125RJ	3	QP, MP-T, QPH, HQP, HQPH, MP-HT, MP-MT	100k	54.06	14.61	11.51
WMLZ42125RJ	MLZ42125RJ	4		100k	64.06	14.61	11.51
WMLZ52125RJ	MLZ52125RJ	5		100k	74.06	14.61	11.51
WMLZ62125RJ	MLZ62125RJ	6		100k	84.06	14.61	11.51

Accessories

Catalog Number	Description
ECWMLZFBUS*	WMLZ's horizontal bussing attachment kit (contains 3 bus bars)
ECWMLZEP	End enclosure plate WMLZ's and WMLZF's
ECWMLZBP	Bottom enclosure plate WMLZ and WMLZF
ECWML10	Replacement metal meter cover for 125A (W)MLZ(F) stacks

* Every WMLZ comes with a ECWMLZFBUS

Power Mod

Applications: WMLZ/ WMLZF – Fusible Residential Lever Bypass Meter Stacks

Flow of Current



- 1 Cables land on a tap box and current enters Power Mod line up on the main horizontal Bus.
- 2 Current is directed from the main horizontal bus down onto the WMLZF's vertical bus and into the 400 amp fuse pull out.
- 3 The current then goes up on the WMLZF's vertical bus to feed the sockets.
- 4 WMLZ's must be fed by a secondary horizontal bus from the WMLZF's
*Additional connections are required between the WMLZ and WMLZF.
- 5 The current then flows up from the secondary horizontal bus and on to the vertical bus to feed the sockets in the WMLZ's.
*More than one WMLZ can be fed from 1 WMLZF.
- 6 The main horizontal bus is used as a pass through on the WMLZ's for any additional modules attached to the line up.
*Quick Connect MUST be used between every module to maintain the line ups Neutral bonding, even if there are no extra modules attached at the end of the line up.

Power Mod

Type WMLZF and WMLZ Utility Meter Stacks: Knockout Diagrams

Fusible Lever Bypass Meter Stacks

3 Meter Stack
WMLZ32125RJ,
MLZ32125RJ

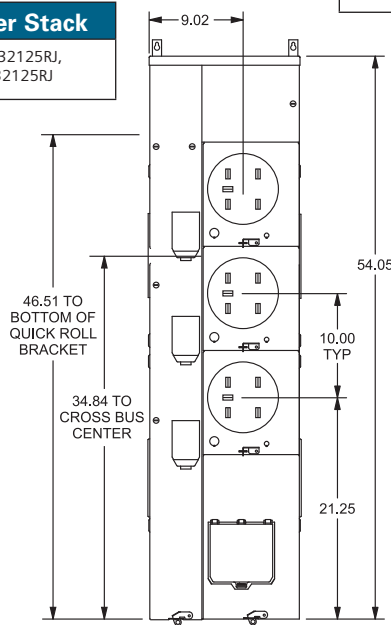

4 Meter Stack
WMLZ42125RJ,
MLZ42125RJ

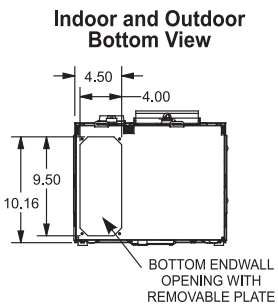
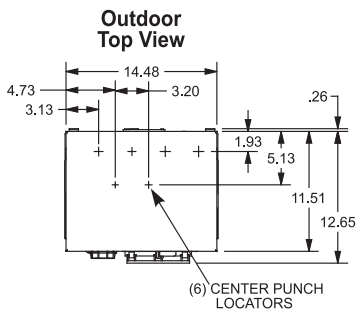
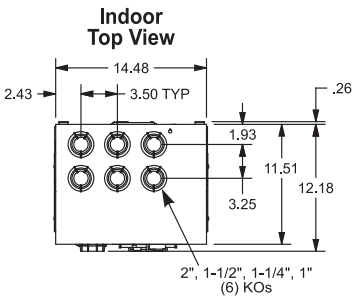
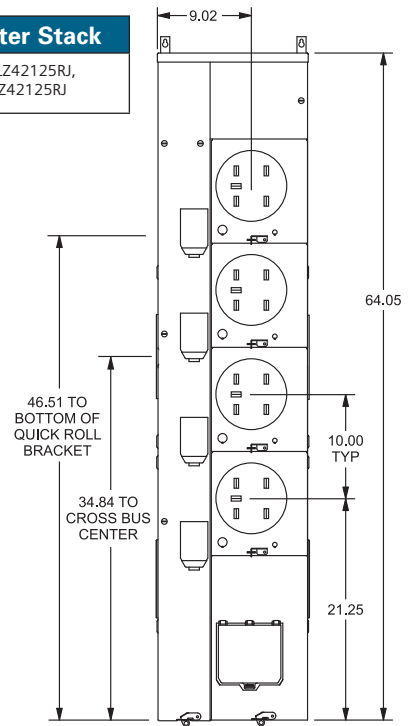

5 Meter Stack
WMLZ52125RJ,
MLZ52125RJ

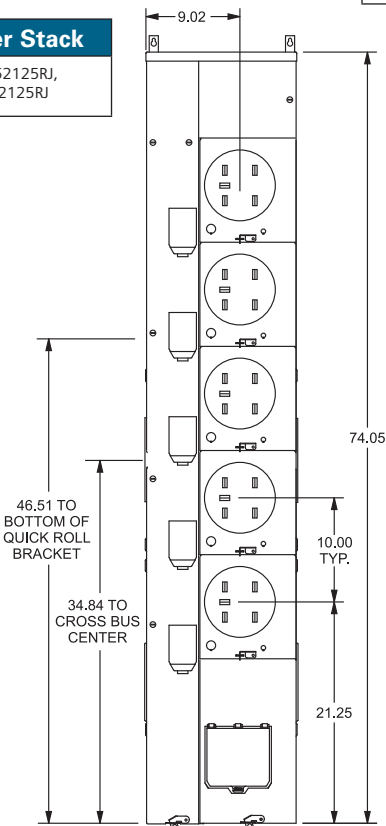

6 Meter Stack
WMLZ62125RJ,
MLZ62125RJ

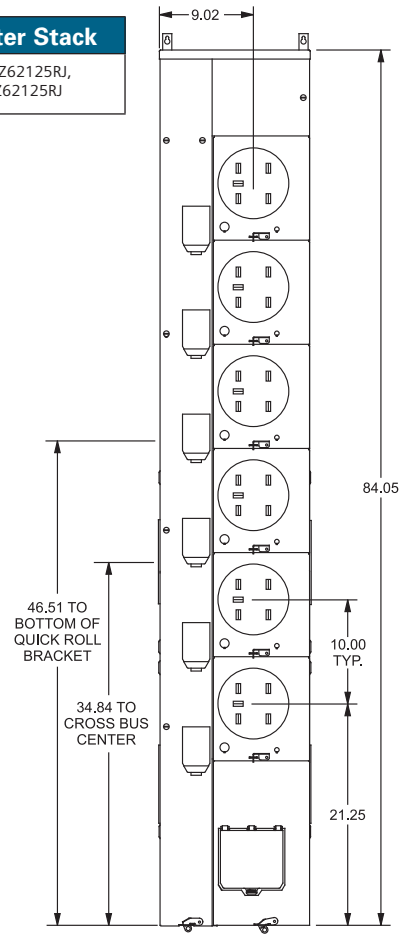

Power Mod

Type WMLZF and WMLZ Utility Meter Stacks: Knockout Diagrams

Non-Fused Lever Bypass Meter Stacks

3 Meter Stack

WMLZF32125RJ,
MLZF32125RJ

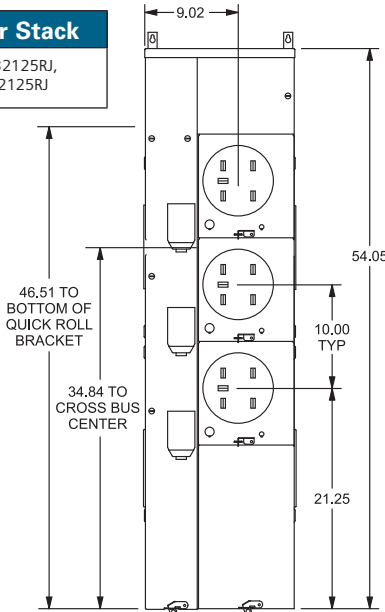

4 Meter Stack

WMLZF42125RJ,
MLZF42125RJ

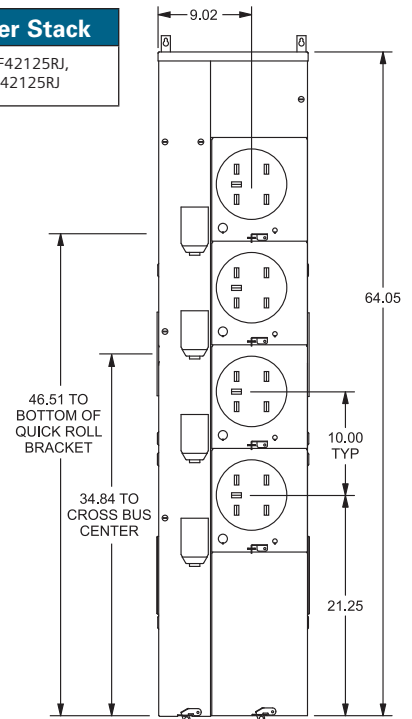

5 Meter Stack

WMLZF52125RJ,
MLZF52125RJ

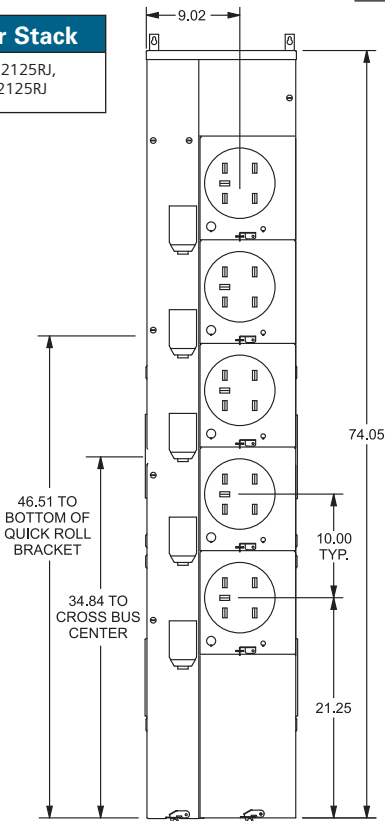

6 Meter Stack

WMLZF62125RJ,
MLZF62125RJ

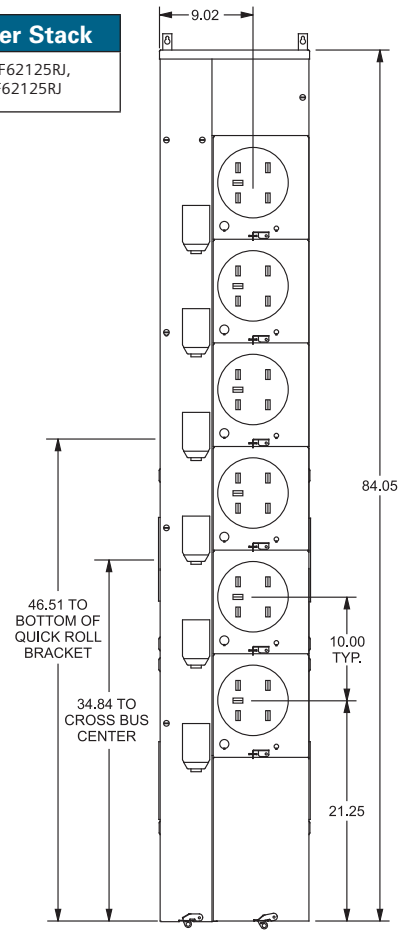

Indoor Top View

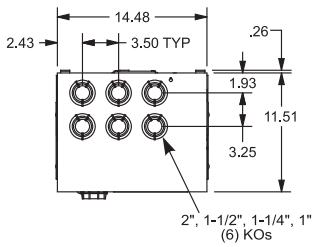

Outdoor Top View

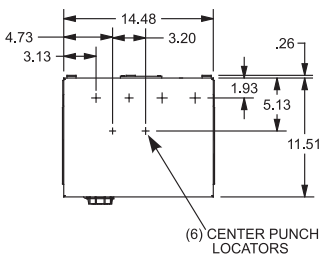

Indoor and Outdoor Bottom View

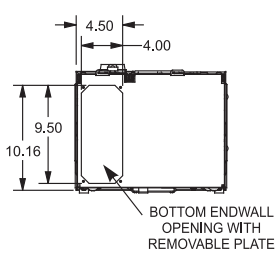

Power Mod

Type WMT Test Block Bypass Meter Stacks

Test Block Bypass Meter Stacks

Commercial Test Block Bypass Meter Stacks (type WMT) are designed to meet the requirements of those utilities specifying test block bypass meter sockets for commercial applications in areas subscribing to the EUSERC standards.

Features include:

- QuickSystem™ features
- High-quality, time-proven Siemens SMM switch-board meter socket
- Removable back knockout plate to facilitate wiring
- 225 Amp capability in single and three phase designs
- Up to 3 positions with 225 Amp tenant mains
- Wiring flexibility - tenant mains require only a single bend
- Three phase input, single phase output modules
- In line wiring: side knockouts allow wiring for adjacent units to pass through

Test Block Bypass Quick Reference

- 225A 1-3 positions
- 1200A horizontal bus rating
- UL Standard #'s UL67
- UL file # E27100
- AIC rating (100K)
- Voltage
 - 1 phase 120/240V AC Max
 - 3 phase in 1 phase out 120Y/208V AC Max
 - 3 phase 240V AC Max
- All swing latches and rivets are stainless steel.
- Outdoor= NEMA 3R rated
- Indoor= NEMA 1R rated
- G90 galvanized Steel
- ANSI 61 Paint
- EUSERC drawing #'s 312 and 353

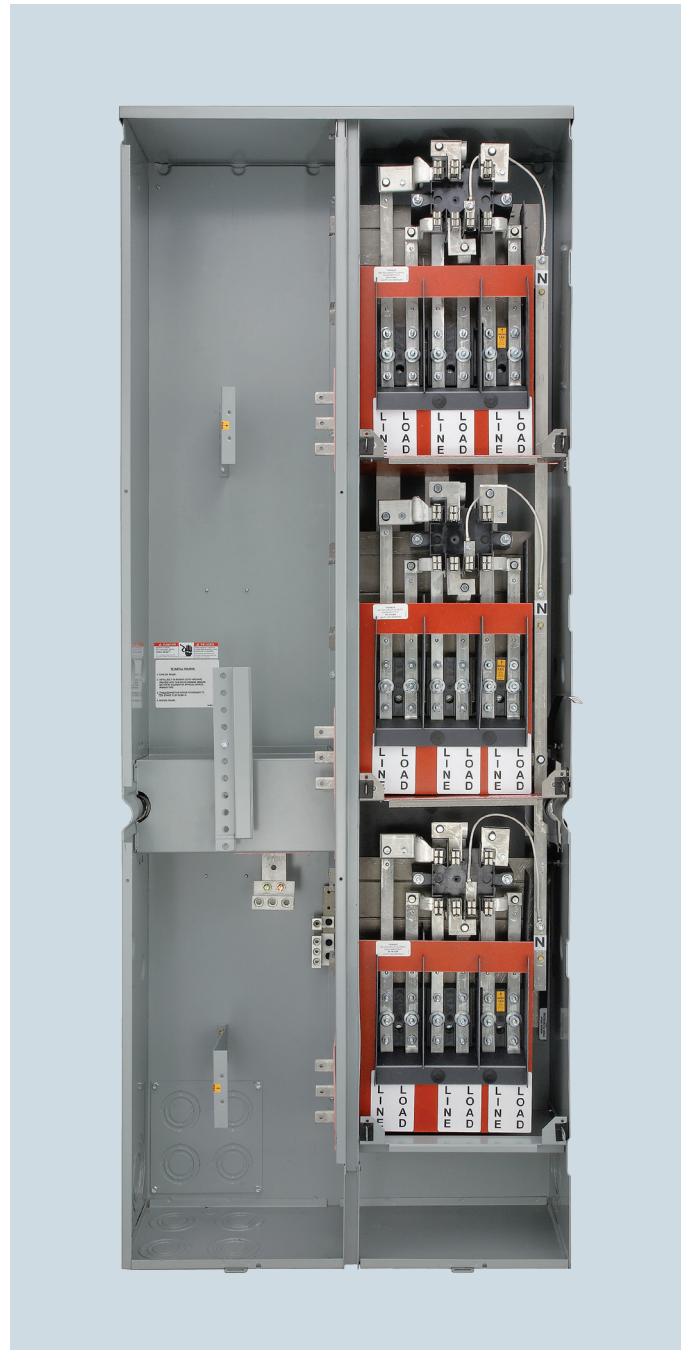

QuickConnect™
Included

Power Mod

Type WMT Test Block Bypass Meter Stacks

- 225A 1-3 positions
- 1200A horizontal bus rating
- AIC Rating (100k)

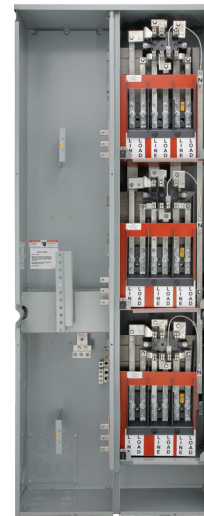

Commercial ring type meter stacks: Test Block Bypass^③

Outdoor Catalog number	Indoor Catalog number	Meter positions per stack	Breaker provisions	Maximum AIC	Dimensions (inches) ^①			Phase	Knockout diagram
					Height	Width	Depth		

1-phase, 3-wire SN, incoming and outgoing, test block bypass, 4-jaw sockets^{② ⑥}

Max. tenant breaker (Amps): 225									
WMT11225	MT11225	1	QS, QSH, QSHH, HQS, HQSH, QP, QPH, HQP, HQPH, MP-T, MP-HT, MP-MT	100k	40.50	21.50	9.00	—	TB-1
WMT21225	MT21225	2			46.00	21.50	9.00	—	TB-2
WMT31225	MT31225	3			65.50	21.50	9.00	—	TB-3

3-phase, 4-wire SN, incoming and 1-phase, 3-wire SN outgoing, test block bypass, 5-jaw sockets^{② ⑤}

Max. tenant breaker (Amps): 225									
WMT12225J	MT12225J	1	QS, QSH, QSHH, HQS, HQSH, QP, QPH, HQP, HQPH, MP-T, MP-HT, MP-MT	100k	40.50	21.50	9.00	AB	TB-1
WMT22AB225J	MT22AB225J	2			46.00	21.50	9.00	1-BC, 1-CA	TB-2
WMT22BC225J	MT22BC225J	2			46.00	21.50	9.00	1-AB, 1-CA	
WMT22CA225J	MT22CA225J	2			46.00	21.50	9.00	1-AB, 1-BC	
WMT32225J	MT32225J	3			65.50	21.50	9.00	1-AB, 1-BC, 1-CA	TB-3

3-phase, 4-wire SN, incoming and outgoing, test block bypass, 7-jaw sockets^④

Max. tenant breaker (Amps): 225									
WMT13225J	MT13225J	1	QR2, QRH2, HQR2, HQR2H, MQ, MQH, MQL	100k	40.50	25.50	9.00	—	TB-4
WMT23225J	MT23225J	2			46.00	25.50	9.00	—	TB-5
WMT33225J	MT33225J	3			65.50	25.50	9.00	—	TB-6

① Dimensions shown are representative of outside box dimensions and do not include allowances for mounting bumps, hubs, or hardware protrusions.

② Not for use on 3-phase, 4-wire delta systems.
 ③ Max AIC determined by maximum AIC of tenant breakers when used in conjunction with a meter socket.

④ Rated for use with 240/120V Delta systems.
 ⑤ Not field phaseable.
 ⑥ Field installable 5th Jaw Kit available (ECMT5).

Power Mod

Type WMK K-Base Meter Stacks

K-Base Meter Stacks

Commercial K-Base Meter Stacks (type WMK) are designed to meet the requirements of those utilities specifying bolt-in meter sockets for 400 and 600 Amp residential and commercial applications.

Features include:

- QuickSystem™ features
- Exclusive Landis & Gyr K4, K5, and K7 meter sockets
- 1 position K4, K5, K7 modules with 400 and 600 Amp tenant mains
- 2 position K7 module with 400 Amp tenant main
- Space saving design

K-Base quick reference

- 400A and 600A 1-2 positions
- 1200A horizontal bus rating
- UL Standard # UL67
- UL file # E27100
- AIC Rating (25k)
- Voltage
 - Single Phase 120/240V AC Max
 - Three In Single Phase Out 208Y/120V AC
 - Three Phase 240V AC Max
- All swing latches and rivets are stainless steel
- NEMA 3R rated
- G90 Galvanized Steel
- ANSI 61 Paint

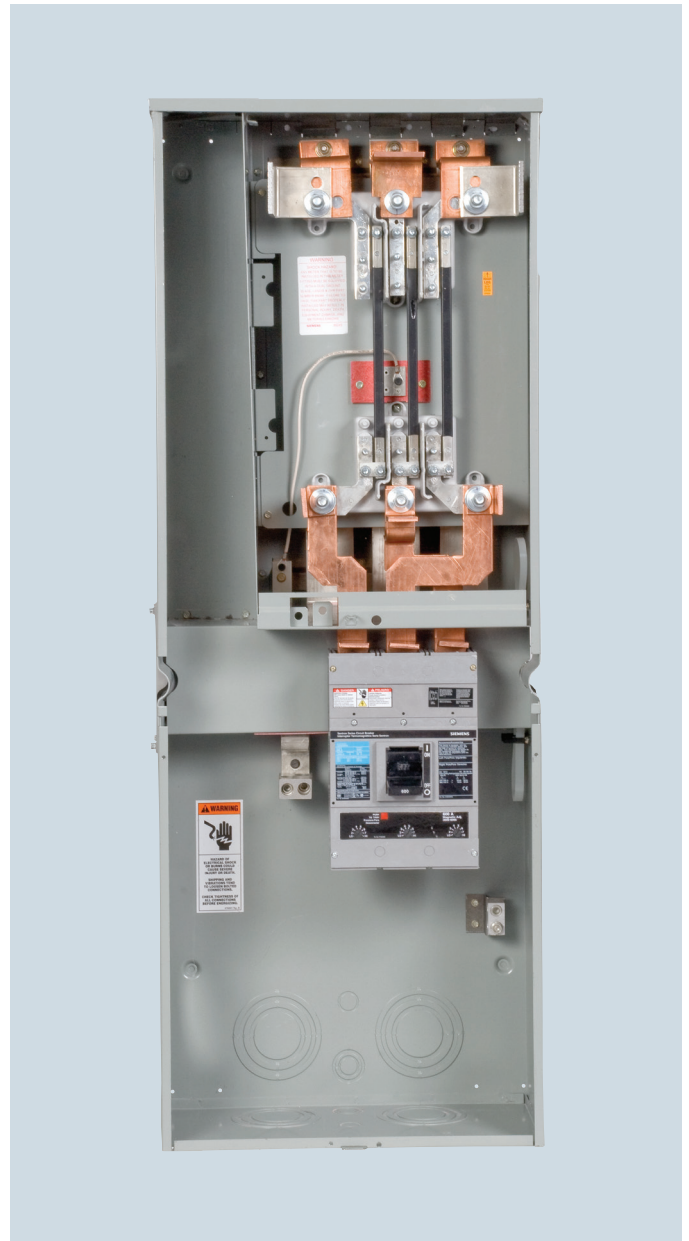

QuickConnect™
Included

Power Mod

Type WMK K-Base Meter Stacks

- 400A and 600A 1-2 positions
- 1200A horizontal bus rating
- AIC Rating (25k)



Commercial ringless type meter stacks: K-Base bolt-in, 25k AIC^{③ ⑥}

Catalog number	Meter positions per stack	Max. tenant breaker (Amps)	Breaker provision ^④	Maximum AIC Rating	Dimensions (inches) ^①			Phase	Knockout Diagram
					Height	Width	Depth		

1-phase, 3-wire SN, incoming and outgoing, K4 K-Base bolt-in

WMK11400R ^④	1	400	JXD62B400 Factory Inst.	25k	54.00	19.25	10.00	—	KB-1
WMK11600R ^⑦	1	600	LXD62B600 Factory Inst.	25k	54.00	19.25	10.00	—	

3-phase, 4-wire SN, incoming and 1-phase, 3-wire SN outgoing, K5 K-Base bolt-in^{② ⑥}

WMK12400RJ ^④	1	400	JXD62B400 Factory Inst.	25k	54.00	19.25	10.00	AB	KB-2
WMK22400RJ	2	400	JXD62B400 Factory Inst.	25k	72.87	27.00	11.00	AC	KB-3

3-phase, 4-wire SN, incoming and outgoing, K7 K-Base bolt-in^⑤

WMK13400RJ ^④	1	400	JXD63B400 Factory Inst.	25k	54.00	19.25	10.00	—	KB-2
WMK23400RJ ^④	2				72.88	27.00	11.00	—	KB-3
WMK13600RJ ^⑦	1	600	LXD63B600 Factory Inst.	25k	54.00	19.25	10.00	—	KB-2

Alternate amperage breakers

Add Suffix ➤	1 Meter Position Per Stack	Breaker Amperage
	T1	200A
	T2	250A
	T3	300A
	T4	350A
	T19	450A
	T20	500A

Add Suffix ➤	2 Meter Positions Per Stack	Breaker Amperage
	T5	200A/200A
	T6	200A/250A
	T7	200A/300A
	T8	200A/350A
	T9	200A/400A
	T10	250A/300A
	T11	250A/350A
	T12	250A/400A
	T13	300A/300A
	T14	300A/350A
	T15	300A/400A
	T16	350A/350A
	T17	350A/400A
	T18	250A/250A

- ① Dimensions shown are representative of outside box dimensions and do not include allowances for mounting bumps, hubs, or hardware protrusions.
- ② Not for use on 3-Phase 4-wire delta systems.
- ③ Max AIC determined by maximum AIC of tenant breakers when used in conjunction with a meter socket. Higher overall ratings may be achieved through approved series rating combinations.
- ④ Alternate amperage breakers are available. Please see table below for suffix that needs to be added for ordering. Extended leadtime may apply. Contact sales office for more details.
- ⑤ Rated for use with 240/120V Delta systems
- ⑥ Not field phaseable
- ⑦ Alternate amperage breakers are available (T19 and T20). Please see table at left for suffix that needs to be added for ordering. Extended leadtime may apply. Contact sales office for more details.

Power Mod

Type WMK K-Base Meter Stacks: Knockout Diagrams

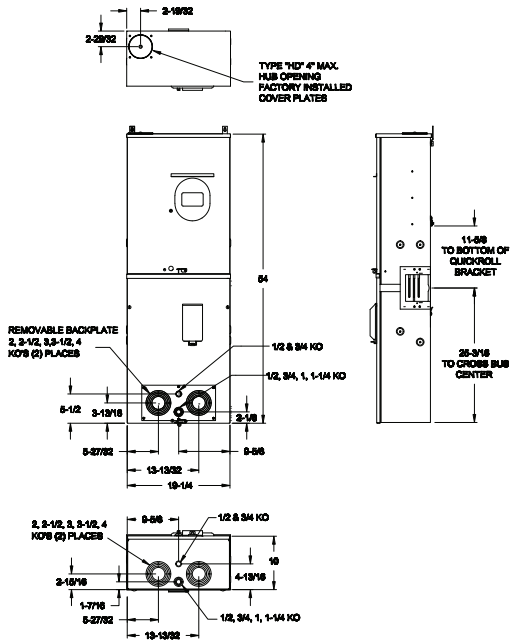

KB-1
WMK11400R
WMK11600R

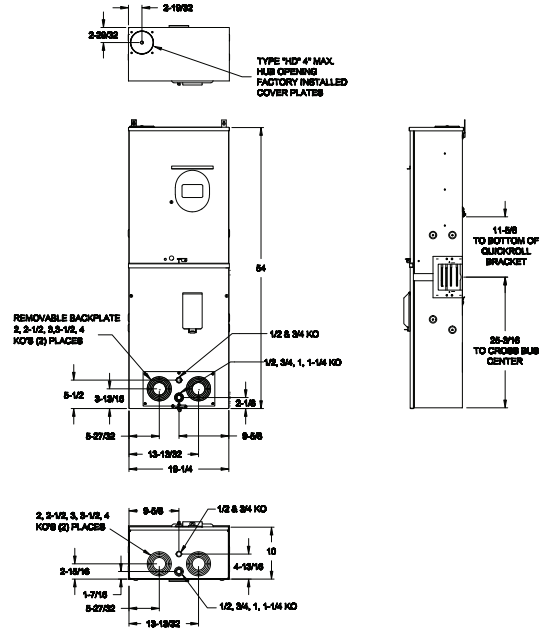

KB-2
WMK12400RJ
WMK13400RJ

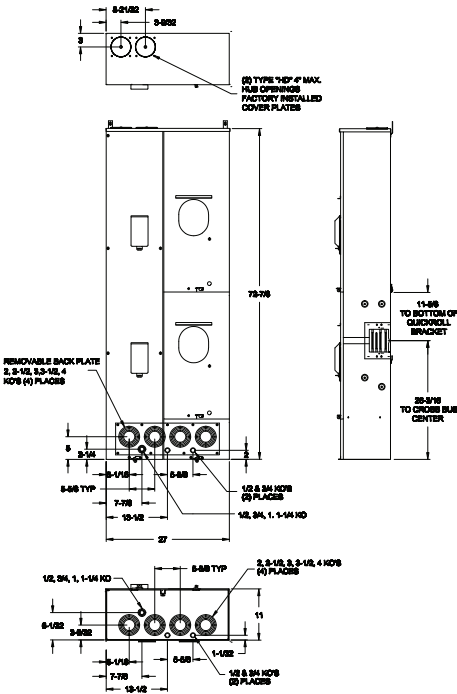

KB-3
WMK22400RJ
WMK23400RJ

Power Mod

Type WC House Power Module

WC Series House Power Module

Power Mod's patented WC family of house power modules offers the ability to combine power distribution to branch circuits within a module that is connected directly to the horizontal bus. This reduces wall space needed, decreases labor and material cost (for installing a separate panel), and simplifies the electrical distribution system.

Key Features of the WC family are:

- Ring or Ringless Covers (horn bypass available with ringless)
- Three or single phase horizontal bus with single phase output
- 20 space, 40 circuit 100K AIC rated interior
- Available subfeed breaker which can be used for large remote loads (such as elevators) or alternative energy inputs (solar)
- Removable knock out plate
- Load wires can exit out of the top, back, or bottom

The line of WC house power modules allow for un-precedented flexibility and savings. All of this while featuring the industry-leading QuickSystem that allows for the fastest install time.

Series House Power Module quick reference

- 1 Position, Single Phase Meter Socket
- 250 Amp maximum rating per device.
- 1200 Amp thru-bus rating
- UL standard 67
- UL file no. E27100
- AIC rating: 100k
- Voltage:
 - Single phase 120/240V AC max.
 - Three phase in single phase out
 - 120/208V AC max.
 - 240/120V AC max.
- All swing latches and rivets are stainless steel.
- Outdoor= NEMA 3R rated
- 20 space, 40 circuit PL Series copper bus interior
- G90 galvanized steel
- ANSI 61 paint
- Optional subfeed or alternative energy input (solar) up to 125amps.

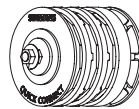
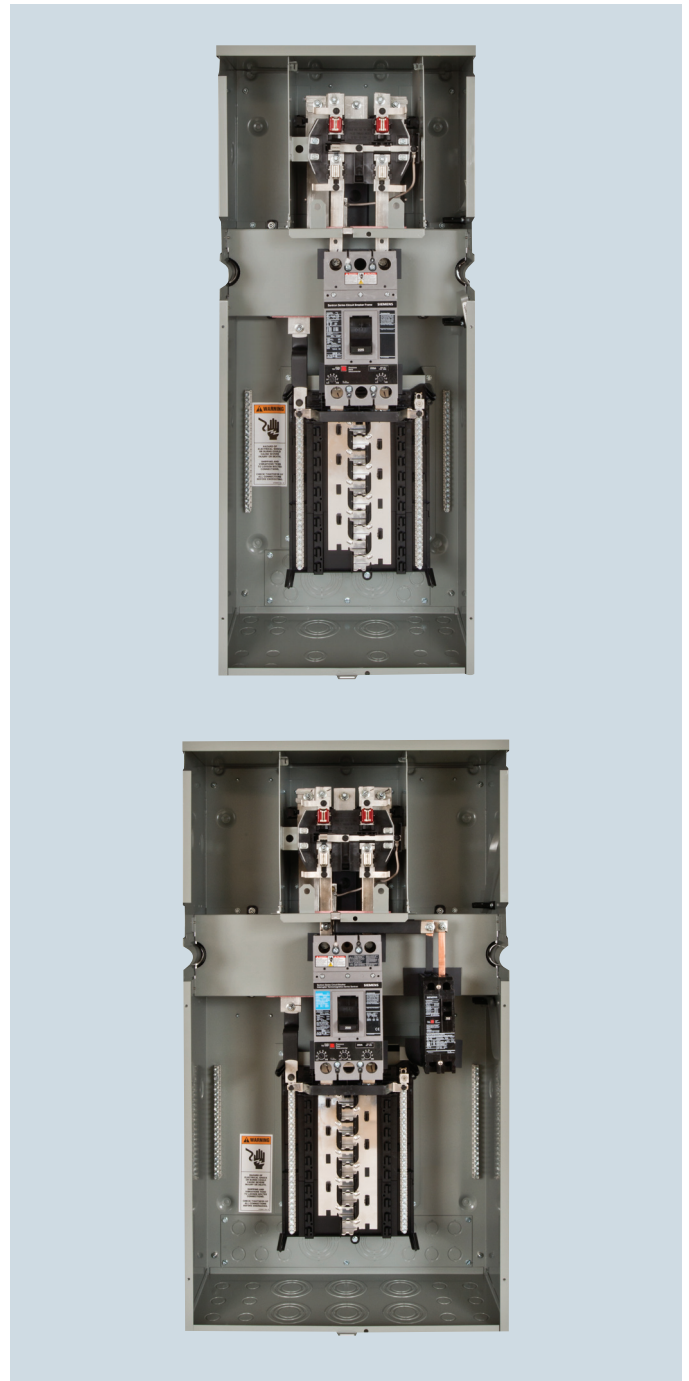

QuickConnect™
Included

Power Mod

Type WC House Power Module: Ring Style

Main Features:

- 1 Position, Single Phase Meter Socket
- 250 Amp maximum rating per device. See below tables for breakdown of allowed amperages depending on the main and subfeed breaker combinations.
- 1200 Amp horizontal bus rating

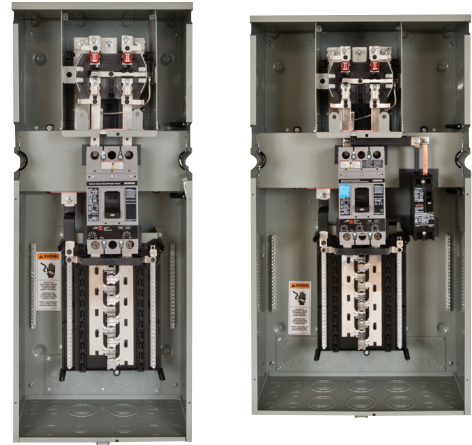

Residential 4-Jaw Ring Type Meter-Loadcenter Stacks: 1-Phase, 3-wire, SN, Horizontal Bus, Distribution, and Subfeed

Catalog Number	Main Breaker - Distribution ^②		Distribution		Subfeed Breaker (Type HED4) ^②	Maximum AIC	Dimensions (inches) ^①			Knockout Diagram
	Amperage	Type	Spaces	Circuits	Amperage		Height	Width	Depth	
WC2040B1T1	225	HFXD6	20	40	N/A	100k	39.10	16.22	12.14	WC-1
WC2040B1T2	200	HFXD6	20	40	50	100k	39.10	21.75	12.14	WC-2
WC2040B1T3	175	HFXD6	20	40	60	100k	39.10	21.75	12.14	
WC2040B1T4	175	HFXD6	20	40	70	100k	39.10	21.75	12.14	
WC2040B1T5	150	HFXD6	20	40	80	100k	39.10	21.75	12.14	
WC2040B1T6	150	HFXD6	20	40	90	100k	39.10	21.75	12.14	
WC2040B1T7	150	HFXD6	20	40	100	100k	39.10	21.75	12.14	
WC2040B1T8	150	HFXD6	20	40	110	100k	39.10	21.75	12.14	
WC2040B1T9	125	HFXD6	20	40	125	100k	39.10	21.75	12.14	

Residential 5-Jaw Ring Type Meter-Loadcenter Stacks: 3-Phase, 4-wire SN, Horizontal Bus and 1-Phase, 3-wire, SN, Distribution and Subfeed

Catalog Number	Main Breaker - Distribution ^②		Distribution		Subfeed Breaker (Type HED4) ^②	Max. AIC	Dimensions (inches) ^①			Phasing ^③	Knockout Diagram
	Amperage	Type	Spaces	Circuits	Amperage		Height	Width	Depth		
WC2040B2T1J	225	HFXD6	20	40	N/A	100k	39.10	16.22	12.14	AC	WC-1
WC2040B2T2J	200	HFXD6	20	40	50	100k	39.10	21.75	12.14	AC	WC-2
WC2040B2T3J	175	HFXD6	20	40	60	100k	39.10	21.75	12.14	AC	
WC2040B2T4J	175	HFXD6	20	40	70	100k	39.10	21.75	12.14	AC	
WC2040B2T5J	150	HFXD6	20	40	80	100k	39.10	21.75	12.14	AC	
WC2040B2T6J	150	HFXD6	20	40	90	100k	39.10	21.75	12.14	AC	
WC2040B2T7J	150	HFXD6	20	40	100	100k	39.10	21.75	12.14	AC	
WC2040B2T8J	150	HFXD6	20	40	110	100k	39.10	21.75	12.14	AC	
WC2040B2T9J	125	HFXD6	20	40	125	100k	39.10	21.75	12.14	AC	

① Dimensions shown are representative of outside box dimensions and do not include allowances for mounting bumps, endwalls, covers, hubs, or hardware protrusions. Dimensions are subject to change.

② Breakers are factory installed.
③ Can be re-phased in the field.

Power Mod

Type WC House Power Module: Ringless Style

Main Features:

- 1 Position, Single Phase Meter Socket
- 250 Amp maximum rating per device. See below tables for breakdown of allowed amperages depending on the main and subfeed breaker combinations.
- 1200 Amp horizontal bus rating

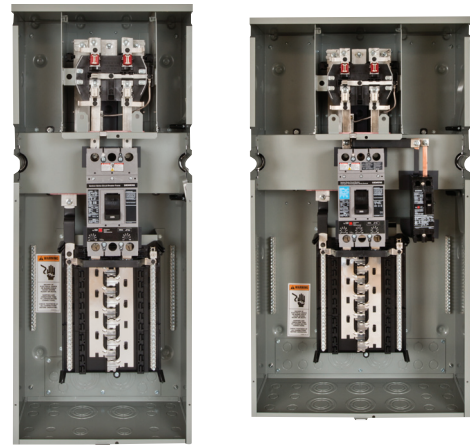

Residential 4 or 5-Jaw Ringless Type Meter-Loadcenter Stacks: 1-Phase, 3-wire, SN, Horizontal Bus, Distribution, and Subfeed

Catalog Number			Main Breaker-Distribution ^②		Distribution		Subfeed Breaker (Type HED4) ^②	Max. AIC	Dimensions ^①			Knockout Diagram
No bypass, 4J	No bypass, 5J	Horn Bypass, 5J	Amp.	Type	Spaces	Circuits	Amperage		Height	Width	Depth	
WC2040B1T1R	WC2040B1T1RJ	WC2040B1T1RJJB	225	HFXD6	20	40	N/A	100k	39.10	16.22	12.14	WC-1
WC2040B1T2R	WC2040B1T2RJ	WC2040B1T2RJJB	200	HFXD6	20	40	50	100k	39.10	21.75	12.14	WC-2
WC2040B1T3R	WC2040B1T3RJ	WC2040B1T3RJJB	175	HFXD6	20	40	60	100k	39.10	21.75	12.14	
WC2040B1T4R	WC2040B1T4RJ	WC2040B1T4RJJB	175	HFXD6	20	40	70	100k	39.10	21.75	12.14	
WC2040B1T5R	WC2040B1T5RJ	WC2040B1T5RJJB	150	HFXD6	20	40	80	100k	39.10	21.75	12.14	
WC2040B1T6R	WC2040B1T6RJ	WC2040B1T6RJJB	150	HFXD6	20	40	90	100k	39.10	21.75	12.14	
WC2040B1T7R	WC2040B1T7RJ	WC2040B1T7RJJB	150	HFXD6	20	40	100	100k	39.10	21.75	12.14	
WC2040B1T8R	WC2040B1T8RJ	WC2040B1T8RJJB	150	HFXD6	20	40	110	100k	39.10	21.75	12.14	
WC2040B1T9R	WC2040B1T9RJ	WC2040B1T9RJJB	125	HFXD6	20	40	125	100k	39.10	21.75	12.14	

Residential 5-Jaw Ringless Type Meter-Loadcenter Stacks: 3-Phase, 4-wire SN, Horizontal Bus and 1-Phase, 3-wire, SN, Distribution and Subfeed

Catalog Number		Main Breaker-Distribution ^②		Distribution		Subfeed Breaker (Type HED4) ^②	Max. AIC	Dimensions ^①			Phasing ^③	Knockout Diagram
No bypass	Horn Bypass	Amp.	Type	Spaces	Circuits	Amperage		Height	Width	Depth		
WC2040B2T1RJ	WC2040B2T1RJJB	225	HFXD6	20	40	N/A	100k	39.10	16.22	12.14	AC	WC-1
WC2040B2T2RJ	WC2040B2T2RJJB	200	HFXD6	20	40	50	100k	39.10	21.75	12.14	AC	WC-2
WC2040B2T3RJ	WC2040B2T3RJJB	175	HFXD6	20	40	60	100k	39.10	21.75	12.14	AC	
WC2040B2T4RJ	WC2040B2T4RJJB	175	HFXD6	20	40	70	100k	39.10	21.75	12.14	AC	
WC2040B2T5RJ	WC2040B2T5RJJB	150	HFXD6	20	40	80	100k	39.10	21.75	12.14	AC	
WC2040B2T6RJ	WC2040B2T6RJJB	150	HFXD6	20	40	90	100k	39.10	21.75	12.14	AC	
WC2040B2T7RJ	WC2040B2T7RJJB	150	HFXD6	20	40	100	100k	39.10	21.75	12.14	AC	
WC2040B2T8RJ	WC2040B2T8RJJB	150	HFXD6	20	40	110	100k	39.10	21.75	12.14	AC	
WC2040B2T9RJ	WC2040B2T9RJJB	125	HFXD6	20	40	125	100k	39.10	21.75	12.14	AC	

① Dimensions shown are representative of outside box dimensions and do not include allowances for mounting bumps, endwalls, covers, hubs, or hardware protrusions. Dimensions are subject to change.

② Breakers are factory installed.
③ Can be re-phased in the field.

Power Mod

Type WC House Power Module: Knockout Diagrams

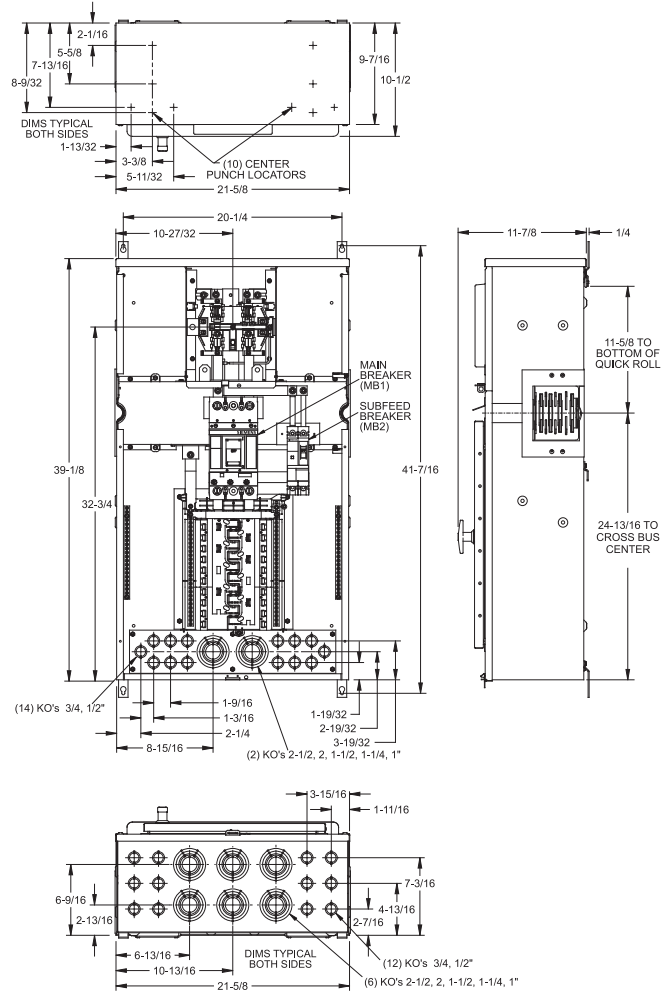
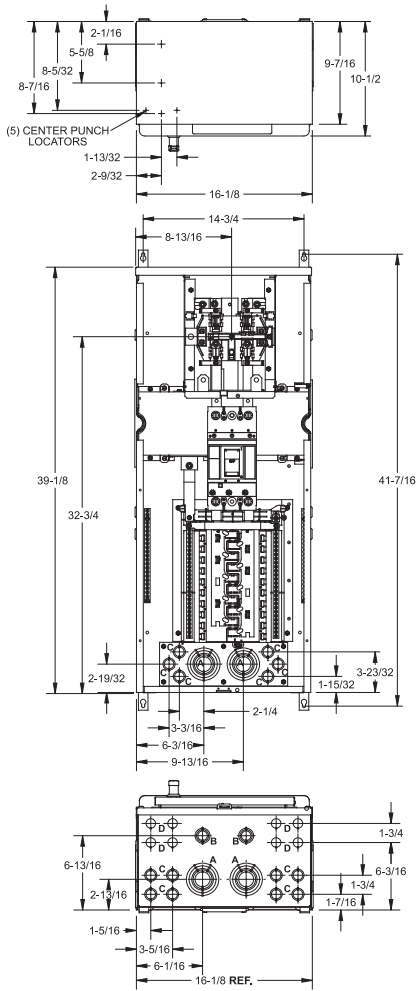

WC-1	
WC2040B1T1	WC2040B2T1J
WC2040B1T1R	WC2040B2T1RJ
WC2040B1T1RJ	WC2040B2T1RJB
WC2040B1T1RJB	

KO Chart		
DESIGNATION	KO SIZE	QTY
A	2-1/2, 2, 1-1/2, 1-1/4, 1"	4
B	1, 3/4, 1/2"	2
C	3/4, 1/2"	14
D	1/2"	8

WC-2		
WC2040B1T2	WC2040B1T2RJ	WC2040B2T2J
WC2040B1T2R	WC2040B1T2RJB	WC2040B2T2RJ
WC2040B1T3	WC2040B1T3RJ	WC2040B2T3RJ
WC2040B1T3R	WC2040B1T3RJB	WC2040B2T3J
WC2040B1T4	WC2040B1T4RJ	WC2040B2T3RJ
WC2040B1T4R	WC2040B1T4RJB	WC2040B2T3RJB
WC2040B1T5	WC2040B1T5RJ	WC2040B2T4J
WC2040B1T5R	WC2040B1T5RJB	WC2040B2T4RJ
WC2040B1T6	WC2040B1T6RJ	WC2040B2T4RJB
WC2040B1T6R	WC2040B1T6RJB	WC2040B2T5J
WC2040B1T7	WC2040B1T7RJ	WC2040B2T5RJ
WC2040B1T7R	WC2040B1T7RJB	WC2040B2T5RJB
WC2040B1T8	WC2040B1T8RJ	WC2040B2T6J
WC2040B1T8R	WC2040B1T8RJB	WC2040B2T6RJ
WC2040B1T9	WC2040B1T9RJ	WC2040B2T6RJB
WC2040B1T9R	WC2040B1T9RJB	WC2040B2T7J
		WC2040B2T7RJ
		WC2040B2T7RJB
		WC2040B2T8J
		WC2040B2T8RJ
		WC2040B2T8RJB
		WC2040B2T9J
		WC2040B2T9RJ
		WC2040B2T9RJB

Power Mod

Type WCL Lever Bypass House Power Module

WCL Series House Power Module

Power Mod's patented WCL (lever bypass) family of house power modules offers the ability to combine power distribution to branch circuits within a module that is connected directly to the horizontal bus. This reduces wall space needed, decreases labor and material cost (for installing a separate panel), and simplifies the electrical distribution system.

Key Features of the WCL family are:

- Talon HQ Lever Bypass ringless meter socket
- Phasing:
 - Single phase horizontal bus with single phase HQ socket and 20 space 40 circuit PL Series copper interior
 - Three phase horizontal bus with single phase HQ socket (phased AC) and 20 space 40 circuit PL Series copper interior
 - Three phase horizontal bus with three phase HQ socket and 24 space 42 circuit PL Series copper interior
- 100K AIC
- Available subfeed breaker which can be used for large remote loads (such as elevators) or alternative energy inputs (solar)
- Removable knock out plate
- Load wires can exit out of the top, back, or bottom

The line of WCL house power modules allow for un-precedented flexibility and savings. All of this while featuring the industry-leading QuickSystem that allows for the fastest install time.

Lever Bypass Series House Power Module quick reference

- Voltage
 - Single Phase 120/240V AC Max
- Talon HQ Lever Bypass Meter Socket
- 1 Position, Single Phase Meter Socket
- 250 Amp maximum rating per device
- 1200A horizontal bus rating
- UL Standard # UL67
- UL file # E27100
- AIC rating 100K
- Voltage
 - Single phase 120/240V AC max
 - Three phase
 - 120/208V AC max.
 - 240/120V AC max.
- All swing latches and rivets are stainless steel.
- Outdoor= NEMA 3R rated
- Interiors: 20 space/40 circuit single phase or 24 space 42 circuit three phase PL Series copper bus
- G90 Galvanized Steel
- ANSI 61 Paint
- Optional subfeed or alternative energy input (solar) up to 125 Amps

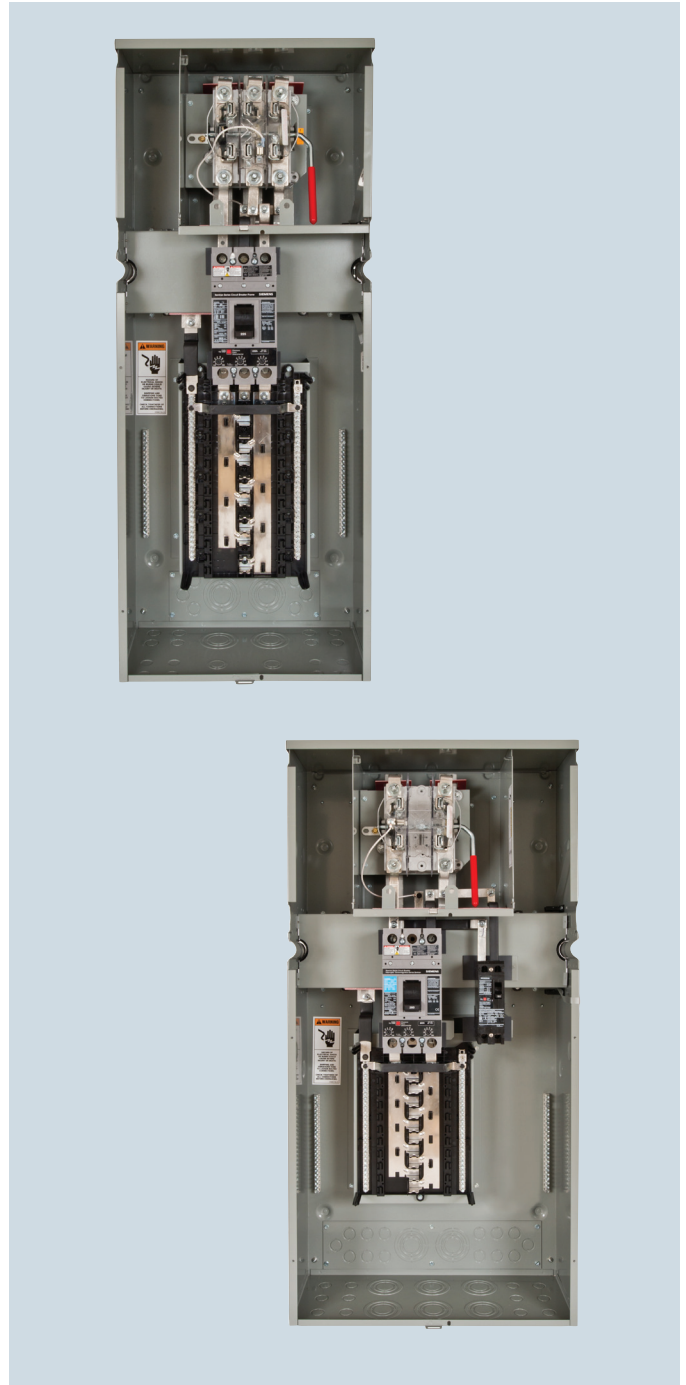

QuickConnect™
Included

Power Mod

Type WCL Lever Bypass House Power Module

Main Features:

- Talon HQ Lever Bypass Meter Socket
- 1 Position, Single Phase Meter Socket
- 250amp maximum rating per device. See below tables for breakdown of allowed amperages depending on the main and subfeed breaker combinations
- 1200A horizontal bus rating

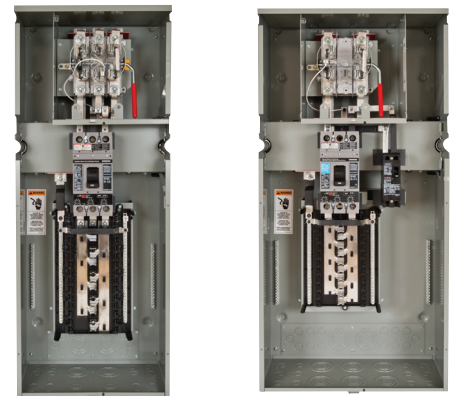

3
METER
CENTERS

Residential 4 or 5-Jaw Ringless Type Meter-Loadcenter Stacks: 1-Phase, 3-wire, SN, Horizontal Bus, Distribution, and Subfeed

Catalog Number	Main Breaker-Distribution ^②		Distribution		Subfeed Breaker (Type HED4) ^②	Max. AIC	Dimensions ^①			Knockout Diagram
	Amperage	Type	Spaces	Circuits	Amperage		Height	Width	Depth	
WCL2040B1T1RJ	225	HFXD6	20	40	N/A	100k	44.63	17.93	12.14	WCL-1
WCL2040B1T2RJ	200	HFXD6	20	40	50	100k	44.63	22.35	12.14	WCL-2
WCL2040B1T3RJ	175	HFXD6	20	40	60	100k	44.63	22.35	12.14	
WCL2040B1T4RJ	175	HFXD6	20	40	70	100k	44.63	22.35	12.14	
WCL2040B1T5RJ	150	HFXD6	20	40	80	100k	44.63	22.35	12.14	
WCL2040B1T6RJ	150	HFXD6	20	40	90	100k	44.63	22.35	12.14	
WCL2040B1T7RJ	150	HFXD6	20	40	100	100k	44.63	22.35	12.14	
WCL2040B1T8RJ	150	HFXD6	20	40	110	100k	44.63	22.35	12.14	
WCL2040B1T9RJ	125	HFXD6	20	40	125	100k	44.63	22.35	12.14	

Commercial 5-Jaw Ringless Type-Lever Bypass Meter-Loadcenter Stacks: 3-Phase, 4-wire SN, Horizontal Bus and 1-Phase, 3-wire, SN, Distribution and Subfeed

Catalog Number	Main Breaker-Distribution ^②		Distribution		Subfeed Breaker (Type HED4) ^②	Max. AIC	Dimensions ^①			Phasing ^③	Knockout Diagram
	Amperage	Type	Spaces	Circuits	Amperage		Height	Width	Depth		
WCL2040B2T1RJ	225	HFXD6	20	40	N/A	100k	44.63	17.93	12.14	AC	WCL-1
WCL2040B2T2RJ	200	HFXD6	20	40	50	100k	44.63	22.35	12.14	AC	WCL-2
WCL2040B2T3RJ	175	HFXD6	20	40	60	100k	44.63	22.35	12.14	AC	
WCL2040B2T4RJ	175	HFXD6	20	40	70	100k	44.63	22.35	12.14	AC	
WCL2040B2T5RJ	150	HFXD6	20	40	80	100k	44.63	22.35	12.14	AC	
WCL2040B2T6RJ	150	HFXD6	20	40	90	100k	44.63	22.35	12.14	AC	
WCL2040B2T7RJ	150	HFXD6	20	40	100	100k	44.63	22.35	12.14	AC	
WCL2040B2T8RJ	150	HFXD6	20	40	110	100k	44.63	22.35	12.14	AC	
WCL2040B2T9RJ	125	HFXD6	20	40	125	100k	44.63	22.35	12.14	AC	

Commercial 7-Jaw Ringless Type-Lever Bypass Meter-Loadcenter Stacks: 3-Phase, 4-wire SN, Horizontal Bus, Distribution and Subfeed

Catalog Number	Main Breaker-Distribution ^②		Distribution		Subfeed Breaker (Type HED4) ^②	Max. AIC	Dimensions ^①			Phasing ^③	Knockout Diagram
	Amperage	Type	Spaces	Circuits	Amperage		Height	Width	Depth		
WCL2442B3T1RJ	225	HFXD6	24	42	N/A	100k	44.63	17.93	12.14	AC	WCL-1
WCL2442B3T2RJ	200	HFXD6	24	42	50	100k	44.63	22.35	12.14	AC	WCL-2
WCL2442B3T3RJ	175	HFXD6	24	42	60	100k	44.63	22.35	12.14	AC	
WCL2442B3T4RJ	175	HFXD6	24	42	70	100k	44.63	22.35	12.14	AC	
WCL2442B3T5RJ	150	HFXD6	24	42	80	100k	44.63	22.35	12.14	AC	
WCL2442B3T6RJ	150	HFXD6	24	42	90	100k	44.63	22.35	12.14	AC	
WCL2442B3T7RJ	150	HFXD6	24	42	100	100k	44.63	22.35	12.14	AC	
WCL2442B3T8RJ	150	HFXD6	24	42	110	100k	44.63	22.35	12.14	AC	
WCL2442B3T9RJ	125	HFXD6	24	42	125	100k	44.63	22.35	12.14	AC	

① Dimensions shown are representative of outside box dimensions and do not include allowances for mounting

bumps, endwalls, covers, hubs, or hardware protrusions. Dimensions are subject to change.

② Breakers are factory installed.
③ Cannot be re-phased in the field.

Power Mod

Type WCL Lever Bypass House Power Module: Knockout Diagrams

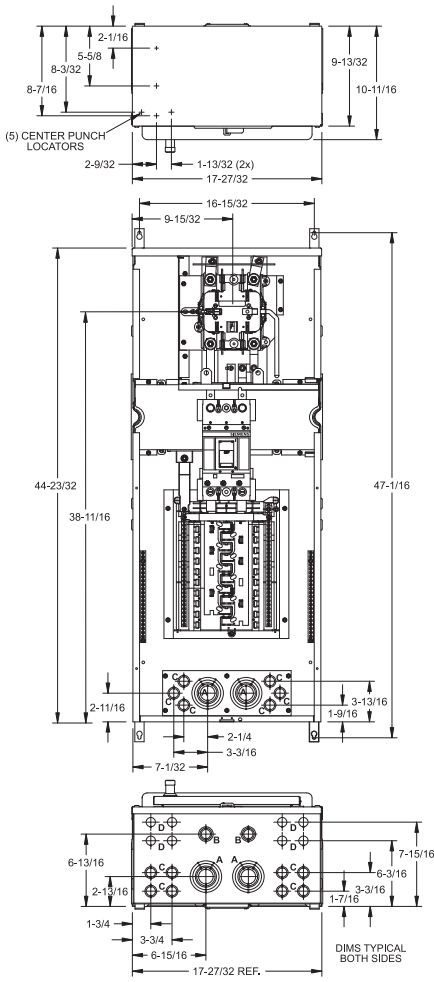

WCL-1	
WCL2040B1T1RJ	
WCL2040B2T1RJ	
WCL2040B3T1RJ	

Knockout Chart		
DESIGNATION	KO SIZE	QTY
A	2-1/2, 2, 1-1/2, 1-1/4, 1"	4
B	1, 3/4, 1/2"	2
C	3/4, 1/2"	14
D	1/2"	8

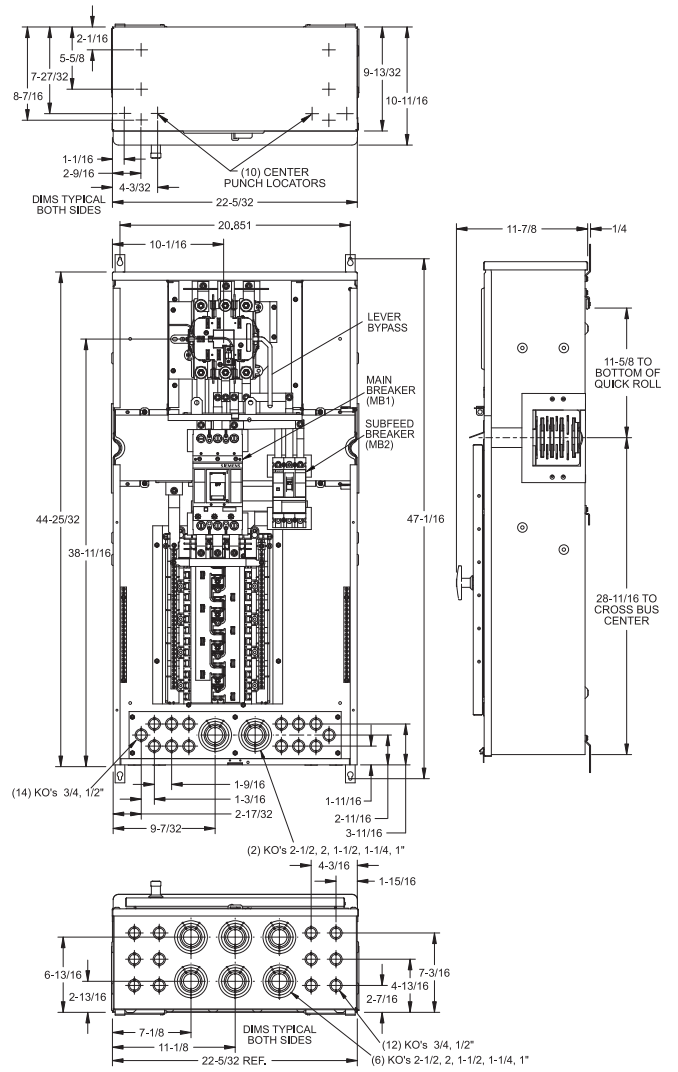

WCL-2		
WCL2040B1T2RJ	WCL2040B2T2RJ	WCL2040B3T2RJ
WCL2040B1T3RJ	WCL2040B2T3RJ	WCL2040B3T3RJ
WCL2040B1T4RJ	WCL2040B2T4RJ	WCL2040B3T4RJ
WCL2040B1T5RJ	WCL2040B2T5RJ	WCL2040B3T5RJ
WCL2040B1T6RJ	WCL2040B2T6RJ	WCL2040B3T6RJ
WCL2040B1T7RJ	WCL2040B2T7RJ	WCL2040B3T7RJ
WCL2040B1T8RJ	WCL2040B2T8RJ	WCL2040B3T8RJ
WCL2040B1T9RJ	WCL2040B2T9RJ	WCL2040B3T9RJ

3
METER
CENTERS

Power Mod

Type WCT Test Block Bypass House Power Module

WCT Series House Power Module

Power Mod's patented WCT (test-block bypass) family of house power modules offers the ability to combine power distribution to branch circuits within a module that is connected directly to the thru bus. This reduces wall space needed, decreases labor and material cost (for installing a separate panel), and simplifies the electrical distribution system.

Key Features of the WCT family are:

- Siemens SMM Switchboard ring-style meter socket
- Phasing:
 - Single phase horizontal bus with a single phase meter socket and 20 space 40 circuit PL Series copper interior
 - Three phase horizontal bus with a single phase meter socket (phased AC) and 20 space 40 circuit PL Series copper interior
 - Three phase horizontal bus with three phase meter socket and 24 space 42 circuit PL Series copper interior
- 100K AIC
- Available subfeed breaker which can be used for large remote loads (such as elevators) or alternative energy inputs (solar)
- Removable knock out plate
- Load wires can exit out of the top, back, or bottom

The line of WCT house power modules allow for un-precedented flexibility and savings. All of this while featuring the industry-leading QuickSystem that allows for the fastest install time.

Test Block Bypass Series House Power Module Quick Reference

- Siemens SMM Switchboard ring-style
- 1 position, Single Phase Meter Socket
- 250amp, maximum rating per device
- 1200amp horizontal bus rating
- UL standard #'s UL 67
- UL file # E270100
- AIC rating 100K
- Voltage
 - 1 phase 120/240V AC max
 - 3 phase 120/208V AC max
 - 3 phase 240/120V AC max
- All swing latches and rivets are stainless steel
- Outdoor= NEMA 3R rated
- Interiors:
 - 20 spaces/40 circuits single phase
 - 24 spaces/42 circuits 3 phase PL Series copper bus
- G90 galvanized steel
- ANSI 61 paint
- Optional subfeed or alternative energy input (solar) up to 125amps
- EUSERC drawing #'s 312 and 353

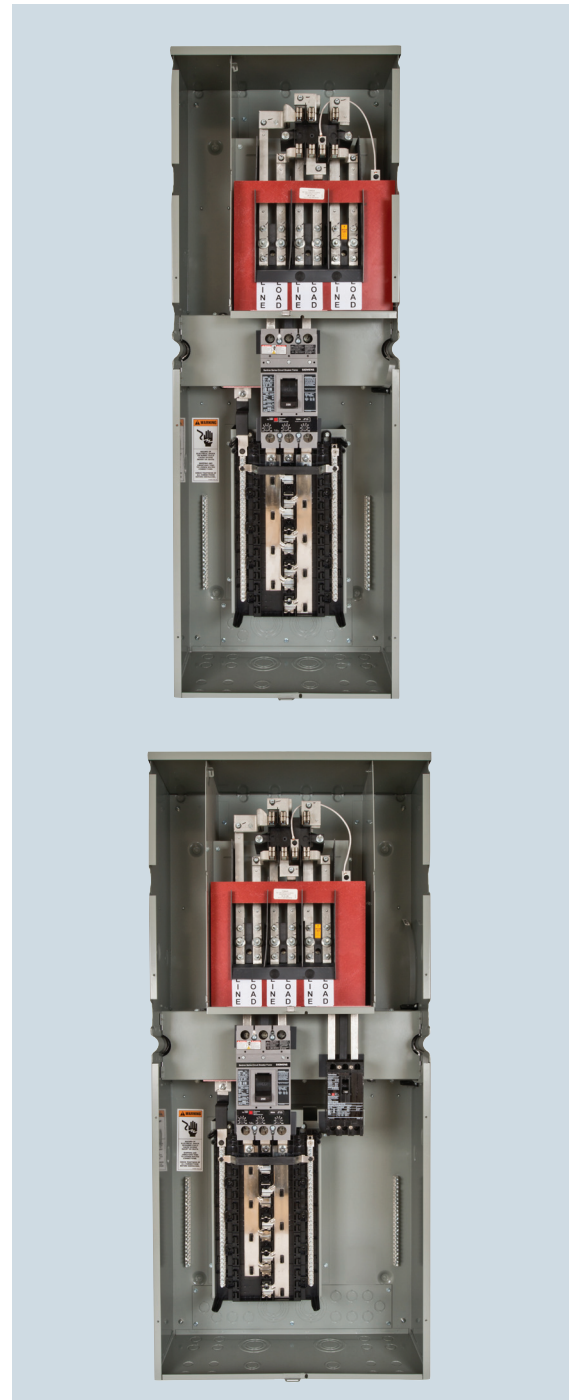

QuickConnect™
Included

Power Mod

Type WCT Test Block Bypass House Power Module

Main Features:

- Siemens SMM Switchboard ring-style
- 1 Position, Single Phase Meter Socket
- 250amp maximum rating per device. See below tables for breakdown of allowed amperages depending on the main and subfeed breaker combinations.
- 1200 Amp horizontal bus rating.



Commercial 4-Jaw Ring Type-Test Block Bypass Meter-Loadcenter Stacks: 1-Phase, 3-wire, SN, Horizontal Bus, Distribution, and Subfeed

Catalog Number	Main Breaker-Distribution ^②		Distribution		Subfeed Breaker (Type HED4) ^②	Max. AIC	Dimensions ^①			Knockout Diagram
	Amperage	Type	Spaces	Circuits	Amperage		Height	Width	Depth	
WCT2040B1T1	225	HFXD6	20	40	N/A	100k	52.1	18.42	12.14	WCT-1
WCT2040B1T2	200	HFXD6	20	40	50	100k	52.1	18.42	12.14	WCT-2
WCT2040B1T3	175	HFXD6	20	40	60	100k	52.1	18.42	12.14	
WCT2040B1T4	175	HFXD6	20	40	70	100k	52.1	18.42	12.14	
WCT2040B1T5	150	HFXD6	20	40	80	100k	52.1	18.42	12.14	
WCT2040B1T6	150	HFXD6	20	40	90	100k	52.1	18.42	12.14	
WCT2040B1T7	150	HFXD6	20	40	100	100k	52.1	18.42	12.14	
WCT2040B1T8	150	HFXD6	20	40	110	100k	52.1	18.42	12.14	
WCT2040B1T9	125	HFXD6	20	40	125	100k	52.1	18.42	12.14	

Commercial 5-Jaw Ring Type-Test Block Bypass Meter-Loadcenter Stacks: 3-Phase, 4-wire SN, Horizontal Bus and 1-Phase, 3-wire, SN, Distribution and Subfeed

Catalog Number	Main Breaker-Distribution ^②		Distribution		Subfeed Breaker (Type HED4) ^②	Max. AIC	Dimensions ^①			Phasing ^③	Knockout Diagram
	Amperage	Type	Spaces	Circuits	Amperage		Height	Width	Depth		
WCT2040B2T1J	225	HFXD6	20	40	N/A	100k	52.1	18.42	12.14	AC	WCT-1
WCT2040B2T2J	200	HFXD6	20	40	50	100k	52.1	18.42	12.14	AC	WCT-2
WCT2040B2T3J	175	HFXD6	20	40	60	100k	52.1	18.42	12.14	AC	
WCT2040B2T4J	175	HFXD6	20	40	70	100k	52.1	18.42	12.14	AC	
WCT2040B2T5J	150	HFXD6	20	40	80	100k	52.1	18.42	12.14	AC	
WCT2040B2T6J	150	HFXD6	20	40	90	100k	52.1	18.42	12.14	AC	
WCT2040B2T7J	150	HFXD6	20	40	100	100k	52.1	18.42	12.14	AC	
WCT2040B2T8J	150	HFXD6	20	40	110	100k	52.1	18.42	12.14	AC	
WCT2040B2T9J	125	HFXD6	20	40	125	100k	52.1	18.42	12.14	AC	

Commercial 7-Jaw Ring Type-Test Block Bypass Meter-Loadcenter Stacks: 3-Phase, 4-wire SN, Horizontal Bus, Distribution and Subfeed

Catalog Number	Main Breaker-Distribution ^②		Distribution		Subfeed Breaker (Type HED4) ^②	Max. AIC	Dimensions ^①			Phasing ^③	Knockout Diagram
	Amperage	Type	Spaces	Circuits	Amperage		Height	Width	Depth		
WCT2442B3T1J	225	HFXD6	24	42	N/A	100k	52.1	18.42	12.14	AC	WCT-1
WCT2442B3T2J	200	HFXD6	24	42	50	100k	52.1	18.42	12.14	AC	WCT-2
WCT2442B3T3J	175	HFXD6	24	42	60	100k	52.1	18.42	12.14	AC	
WCT2442B3T4J	175	HFXD6	24	42	70	100k	52.1	18.42	12.14	AC	
WCT2442B3T5J	150	HFXD6	24	42	80	100k	52.1	18.42	12.14	AC	
WCT2442B3T6J	150	HFXD6	24	42	90	100k	52.1	18.42	12.14	AC	
WCT2442B3T7J	150	HFXD6	24	42	100	100k	52.1	18.42	12.14	AC	
WCT2442B3T8J	150	HFXD6	24	42	110	100k	52.1	18.42	12.14	AC	
WCT2442B3T9J	125	HFXD6	24	42	125	100k	52.1	18.42	12.14	AC	

① Dimensions shown are representative of outside box dimensions and do not include allowances for

mounting bumps, endwalls, covers, hubs, or hardware protrusions. Dimensions are subject to change.

② Breakers are factory installed.
③ Cannot be re-phased in the field.

Power Mod

Type WCT Test Block Bypass House Power Module: Knockout Diagrams

3
METER
CENTERS

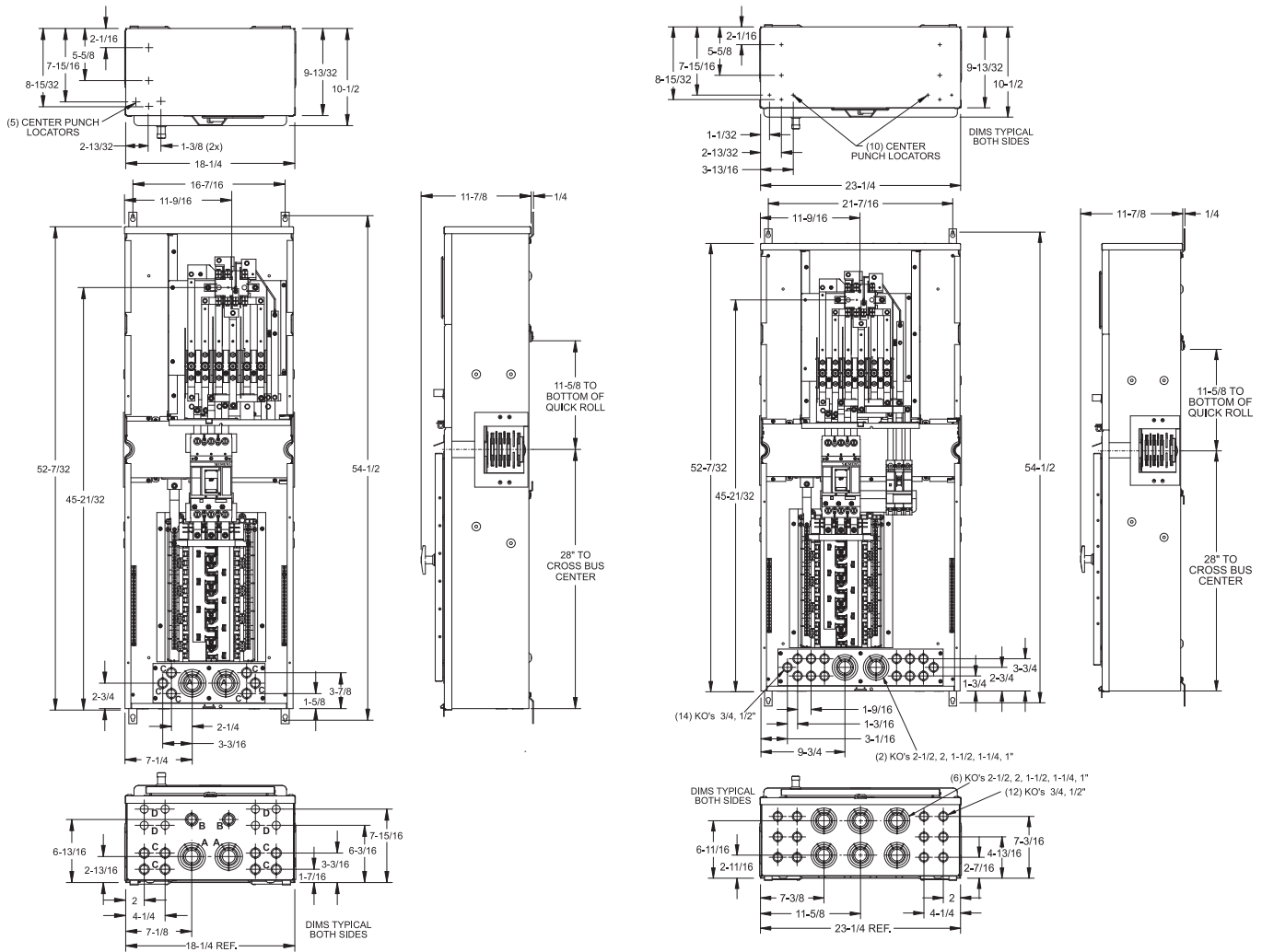

WCT-1

WCT2040B1T1
WCT2040B2T1J
WCT2040B3T1J

Knockout Chart

DESIGNATION	KO SIZE	QTY
A	2-1/2, 2, 1-1/2, 1-1/4, 1"	4
B	1, 3/4, 1/2"	2
C	3/4, 1/2"	14
D	1/2"	8

WCT-2

WCT2040B1T2	WCT2040B2T2J	WCT2442B3T2J
WCT2040B1T3	WCT2040B2T3J	WCT2442B3T3J
WCT2040B1T4	WCT2040B2T4J	WCT2442B3T4J
WCT2040B1T5	WCT2040B2T5J	WCT2442B3T5J
WCT2040B1T6	WCT2040B2T6J	WCT2442B3T6J
WCT2040B1T7	WCT2040B2T7J	WCT2442B3T7J
WCT2040B1T8	WCT2040B2T8J	WCT2442B3T8J
WCT2040B1T9	WCT2040B2T9J	WCT2442B3T9J

Power Mod

Type WSPD Surge Protection Modules

WSPD Surge Protection Modules

Surge protection modules for Power Mod (type WSPD) are horizontal bus connected modules that allow the user to view surge status as well as access the SPD control panel without breaking the utility seal on the enclosure. An optional breaker disconnect is available to enable the end user to replace the SPD (surge protection device) without having to disconnect utility power to the Power Mod installation.

Features include:

- QuickSystem™ features
- 100, 200, 300, 400, 500kA ratings available
- External, vandal resistant and lockable clear cover over SPD control panel
- Single phase horizontal bus and three phase horizontal bus
- Optional breaker disconnect that opens phase and neutral to make SPD replacement quick and easy

Surge Protection Module quick reference

- 100-500 kA rating
- 1200amp horizontal bus rating
- UL standard #67
- UL file # E27100
- AIC rating: 100K
- Voltage
 - Single phase 120/240V AC max
 - Three phase 240V AC max
- All swing latches and rivets are stainless steel
- NEMA 3R rated
- ANSI 61 paint

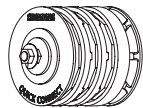

QuickConnect™
Included



Power Mod

Type WSPD Surge Protection Modules: Knockout Diagrams

Main Features:

- 100-500kA ratings
- 1200 amp horizontal bus rating
- Suitable for 100k AIC applications

Lugs not required.



1-phase, 3-wire SN, 120/240V AC

Catalog Number (with HEG Breaker Disconnect)	Catalog Number (no disconnect)	Breaker Type	kA Surge Current ^②	Dimensions (inches) ^①			Knockout Diagram
				Height	Width	Depth	
WSPD1B10A	WSPD1N10A	HEG	100	29.19	13.38	7.91	WSPD-B = Breaker WSPD-N = No breaker
WSPD1B20A	WSPD1N20A	HEG	200	29.19	13.38	7.91	
WSPD1B30A	WSPD1N30A	HEG	300	29.19	13.38	7.91	
WSPD1B40A	WSPD1N40A	HEG	400	29.19	13.38	7.91	
WSPD1B50A	WSPD1N50A	HEG	500	29.19	13.38	7.91	

3-phase, 4-wire SN, Delta 240/120V AC

Catalog Number (with HEG Breaker Disconnect)	Catalog Number (no disconnect)	Breaker Type	kA Surge Current ^②	Dimensions (inches) ^①			Knockout Diagram
				Height	Width	Depth	
WSPD3B10B	WSPD3N10B	HEG	100	29.19	13.38	7.91	WSPD-B = Breaker WSPD-N = No breaker
WSPD3B20B	WSPD3N20B	HEG	200	29.19	13.38	7.91	
WSPD3B30B	WSPD3N30B	HEG	300	29.19	13.38	7.91	
WSPD3B40B	WSPD3N40B	HEG	400	29.19	13.38	7.91	
WSPD3B50B	WSPD3N50B	HEG	500	29.19	13.38	7.91	

3-phase, 4-wire SN, Wye 208/120V AC

Catalog Number (with HEG Breaker Disconnect)	Catalog Number (no disconnect)	Breaker Type	kA Surge Current ^②	Dimensions (inches) ^①			Knockout Diagram
				Height	Width	Depth	
WSPD3B10C	WSPD3N10C	HEG	100	29.19	13.38	7.91	WSPD-B = Breaker WSPD-N = No breaker
WSPD3B20C	WSPD3N20C	HEG	200	29.19	13.38	7.91	
WSPD3B30C	WSPD3N30C	HEG	300	29.19	13.38	7.91	
WSPD3B40C	WSPD3N40C	HEG	400	29.19	13.38	7.91	
WSPD3B50C	WSPD3N50C	HEG	500	29.19	13.38	7.91	

① Dimensions shown are representative of outside box dimensions and do not include allowances for mounting

bumps, endwalls, covers, hubs, or hardware protrusions. Dimensions are subject to change.

② 200 - 500kA devices require additional lead time. Please contact sales office for details on lead time.

Power Mod

Type WSPD Surge Protection Modules: Knockout Diagrams

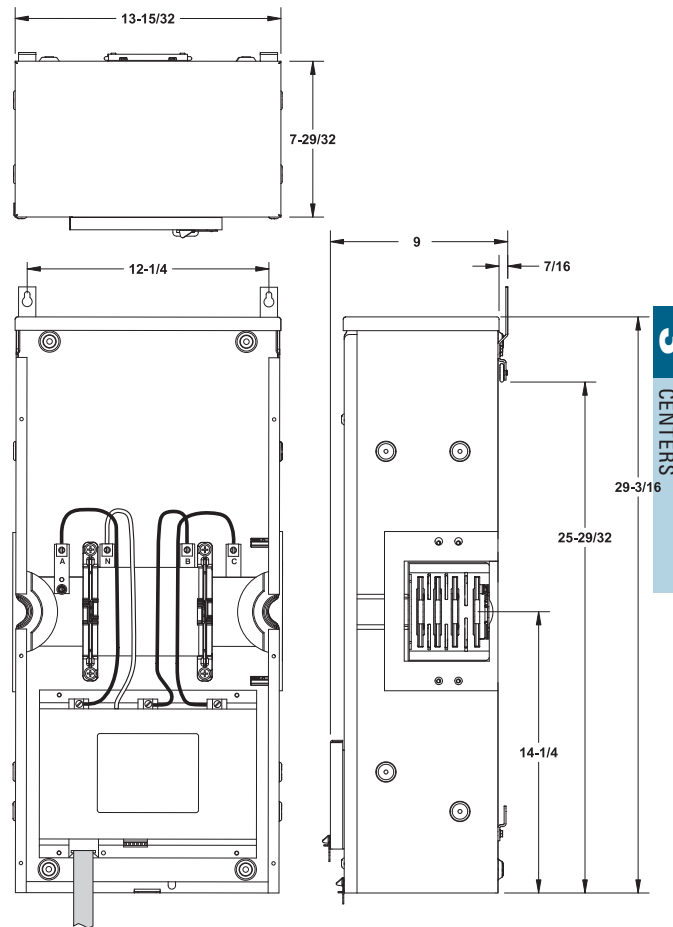
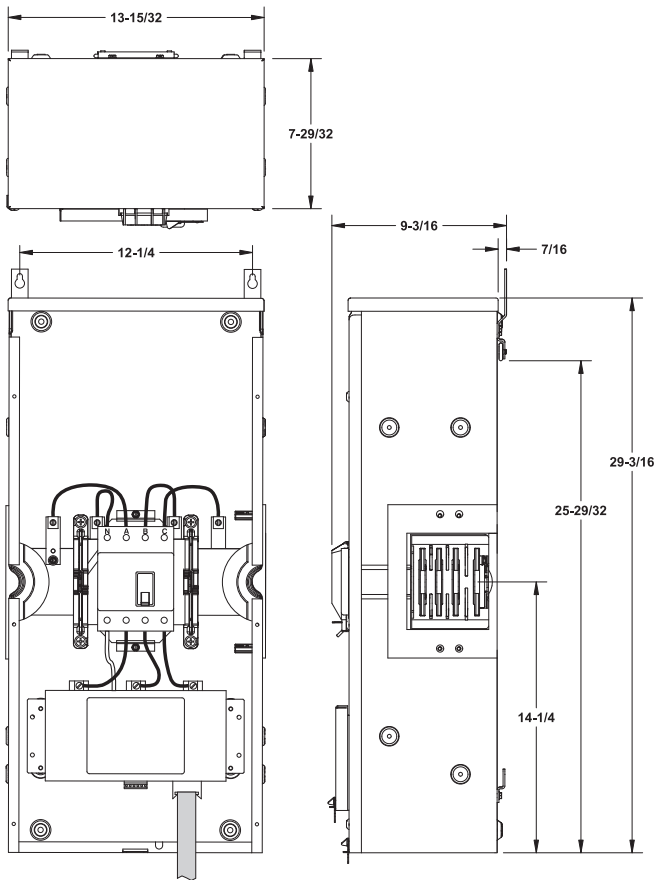

3
METER
CENTERS

WSPD-B

WSPD1B10A	WSPD3B10B
WSPD1B20A	WSPD3B10C
WSPD1B30A	WSPD3B20B
WSPD1B40A	WSPD3B20C
WSPD1B50A	WSPD3B30B
	WSPD3B30C
	WSPD3B40B
	WSPD3B40C
	WSPD3B50B
	WSPD3B50C

With breaker disconnect

WSPD-N

WSPD1N10A	WSPD3N10B
WSPD1N20A	WSPD3N10C
WSPD1N30A	WSPD3N20B
WSPD1N40A	WSPD3N20C
WSPD1N50A	WSPD3N30B
	WSPD3N30C
	WSPD3N40B
	WSPD3N40C
	WSPD3N50B
	WSPD3N50C

No breaker disconnect

Power Mod

Type WMN ConEd Residential Meter Stacks

WMN ConEd Residential Meter Stacks

Siemens Consolidated Edison Residential Meter Stacks are packed with features inside and out; our exclusive knock out plate offers flexibility when pulling wires to the stack, moveable neutrals and grounds to save wire, and all of the QuickSystem features all designed with the contractor in mind. Features 10" socket center-to-center distance to allow use of meter pulling tools.

3
METER
CENTERS

Surge Protection Module quick reference

- 2-6 gang
- 125/225 Amp per position
- 1200Amp horizontal bus rating
- UL standard 67
- UL file no. E27100
- AIC rating: (100K)
- Voltage
 - 3 phase in single phase out
 - 240V AC max
- All swing latches and rivets are stainless steel
- Outdoor = NEMA 3R rated
- Indoor = NEMA 1R rated
- G90 galvanized steel
- ANSI 61 paint

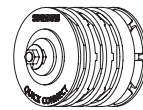

QuickConnect™
Included

Power Mod

Type WMN ConEd Residential Meter Stacks

Main Features:

- 2-6 gang
- 1200 amp horizontal bus rating
- Suitable for 100k AIC applications



Residential 5-jaw ring type meter stacks; 3-phase, 4-wire SN, incoming and 1-phase, 3 wire SN outgoing^③

Outdoor Catalog number	Indoor Catalog number	Meter positions per stack	Breaker provision	Maximum AIC ^④	Dimensions (inches) ^①			Knockout Diagram
					Height	Width	Depth	
Max. tenant breaker (Amps): 125								
WMN22125J	MN22125J	2	QP, QPH, HQP, HQPH, MP-T, MP-HT, MPMT	100k	35.31	12.97	8.09	WMN-1
WMN32125J	MN32125J	3		100k	46.31	12.97	8.09	WMN-2
WMN42125J	MN42125J	4		100k	56.31	12.97	8.09	WMN-3
WMN52125J	MN52125J	5		100k	66.31	12.97	8.09	WMN-4
WMN62125J	MN62125J	6		100k	76.31	12.97	8.09	WMN-5
Max. tenant breaker (Amps): 225^{②⑤}								
WMN22225J	MN22225J	2	QS, QSH, QSHH, HQS, HQSH, QP, QPH, HQP, HQPH, MP-T, MP-HT, MPMT	100k	35.31	16.09	8.09	WMN-6
WMN32225J	MN32225J	3		100k	46.31	16.09	8.09	WMN-7
WMN42225J	MN42225J	4		100k	56.31	16.09	8.09	WMN-8
WMN52225J	MN52225J	5		100k	66.31	16.09	8.09	WMN-9
WMN62225J	MN62225J	6		100k	76.31	16.09	8.09	WMN-10

① Dimensions shown are representative of outside box dimensions and do not include allowances for mounting bumps, endwalls, covers, hubs, or hardware protrusions. Dimensions are subject to change.

② 225A available in lower three positions only. 200A continuous for all other positions.

③ Must use QuickPhase features to route all sockets AWAY from high-leg when 240/120 Delta voltage is used.

④ Max AIC determined by maximum AIC of tenant breakers.

⑤ Install QP breakers below QS.

Power Mod

Type WMN ConEd Residential Meter Stacks: Knockout Diagrams

WMN-1

WMN22125J
MN22125J

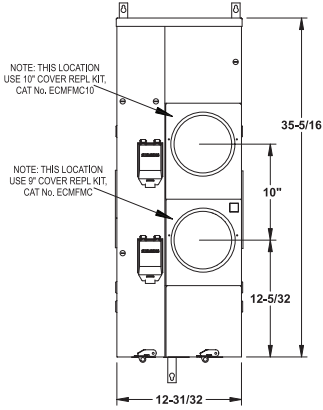

WMN-2

WMN32125J
MN32125J

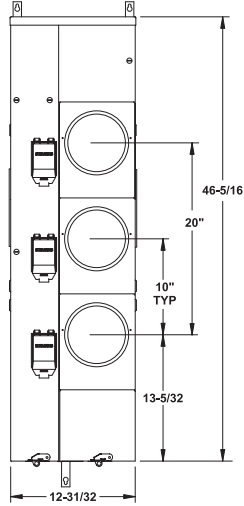

WMN-3

WMN42125J
MN42125J

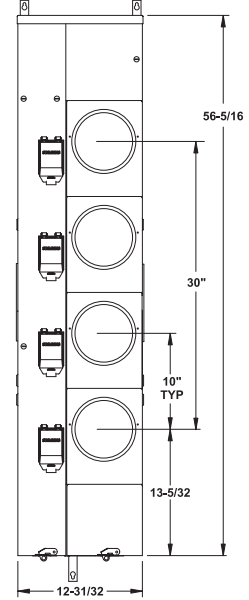

125 Amp Typical Top View for NEMA 1

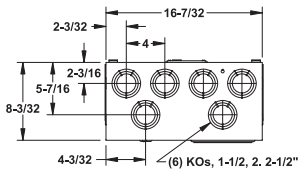

125 Amp Typical Top View for NEMA 3R

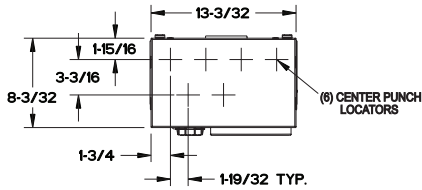

125 Amp Typical Bottom View

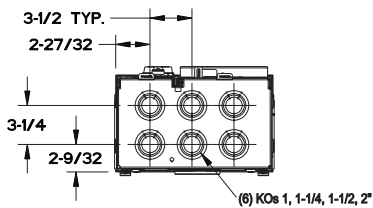

WMN-4

WMN52125J
MN52125J

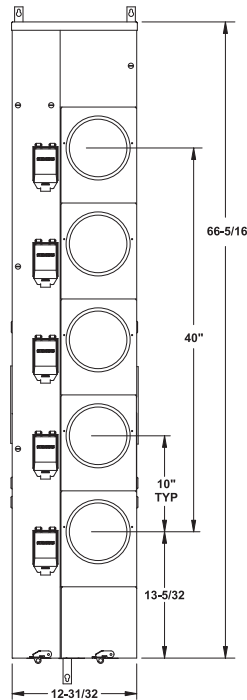

WMN-5

WMN52125J
MN62125J

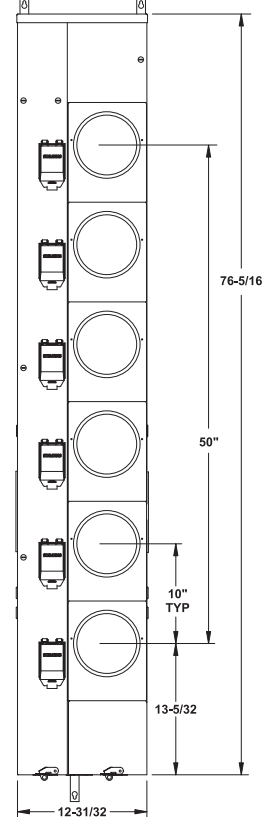

Power Mod

Type WMN ConEd Residential Meter Stacks: Knockout Diagrams

WMN-6
WMN22225J
MN22225J

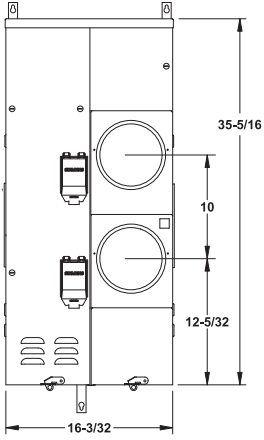

WMN-7
WMN32225J
MN32225J

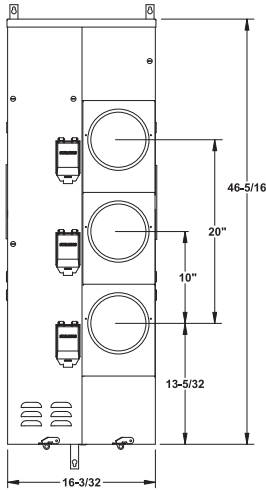

WMN-8
WMN42225J
MN42225J

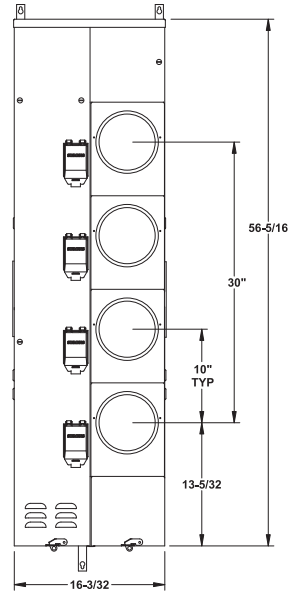

225 Amp Typical Top View for NEMA 1

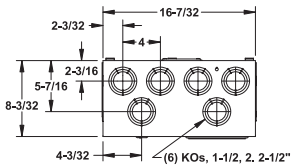

225 Amp Typical Top View for NEMA 3R

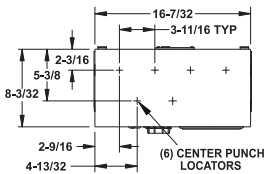

225 Amp Typical Bottom View

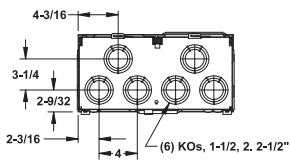

WMN-9
WMN52225J
MN52225J

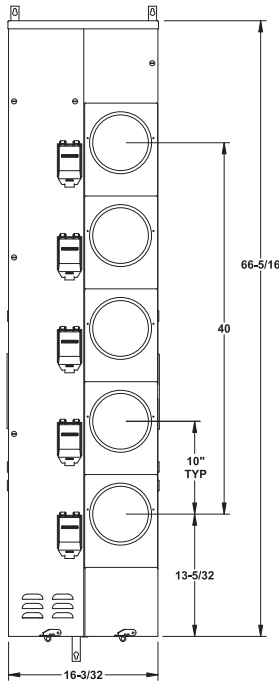

WMN-10
WMN62225J
MN62225J

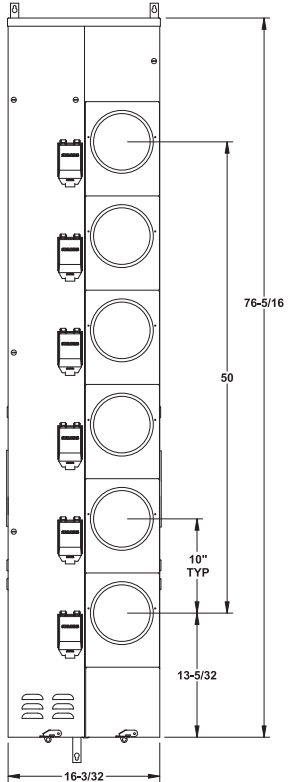

Power Mod

Type WTBN ConEd Tap boxes

Type WTBN ConEd Tap boxes

ConEd Tap Boxes (type WTBN) are designed to meet the requirements of the Consolidated Edison Utility service area. WTBN tap boxes feature a shallow depth for front and rear alignment with WMN stacks.

3

METER
CENTERS

ConEd Tap boxes

- 400-1200A module rating
- 1200Amp horizontal bus rating
- UL standard # UL67
- UL file no. E27100
- AIC rating: (100K AIC)
- Voltage
 - 3 phase in single phase out
 - 240V AC max
- All swing latches and rivets are stainless steel
- NEMA 3R rated
- G90 galvanized steel
- ANSI 61 paint

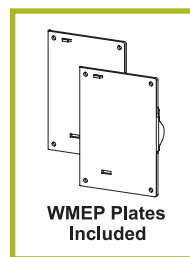

Power Mod





Type WTBN ConEd Tap boxes

Main Features:

- 400-1200A
- 1200 amp horizontal bus rating
- Suitable for 100k AIC applications



Tap Box modules: 3-phase, 4 wire SN, 208/120V AC Max

Catalog number (100k AC)	Catalog number (100k AC) Blank Endwall	Ampere Rating	Service feed [®]	Dimensions (inches) ^①			Line Side Connections (Lugs)	Knockout Diagram
				Height	Width	Depth		
WTBN3400CU	WTBN3400CUNH	400	OH/UG	48.81	17.63	8.063	1 Set Of 2 Studs 	WTBN-1
WTBN3600CU	WTBN3600CUNH	600	OH/UG	48.81	17.63	8.063	1 Set Of 2 Studs 	WTBN-2
WTBN3800CU	WTBN3800CUNH	800	OH/UG	52.84	25.63	8.094	2 Sets Of 2 Studs 	WTBN-3
WTBN31200CU	WTBN31200CUNH	1200	OH/UG	64.47	25.63	8.094	2 Sets Of 2 Studs 	WTBN-4

^① Dimensions shown are representative of outside box dimensions and do not include allowances for mounting

bumps, endwalls, covers, hubs, or hardware protrusions. Dimensions are subject to change.

[®] Devices have studs on top and bottom, but only one side should be used.

Power Mod

Type WTBN ConEd Tap boxes

3
METER
CENTERS

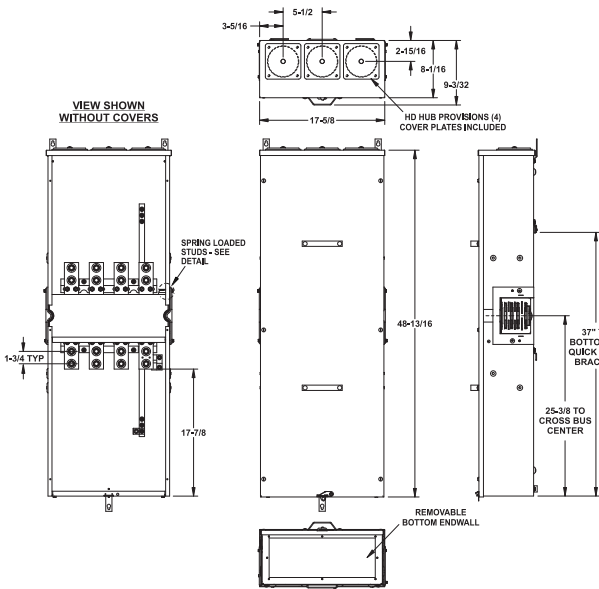

WTBN-1
WTBN3400CU

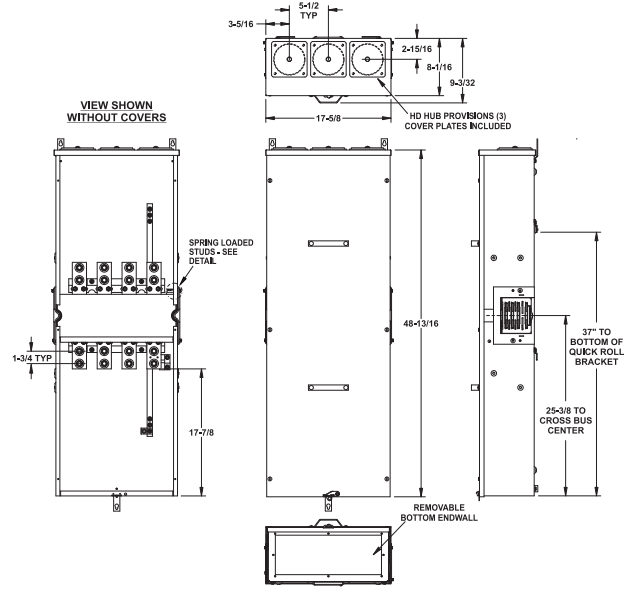

WTBN-2
WTBN3600CU

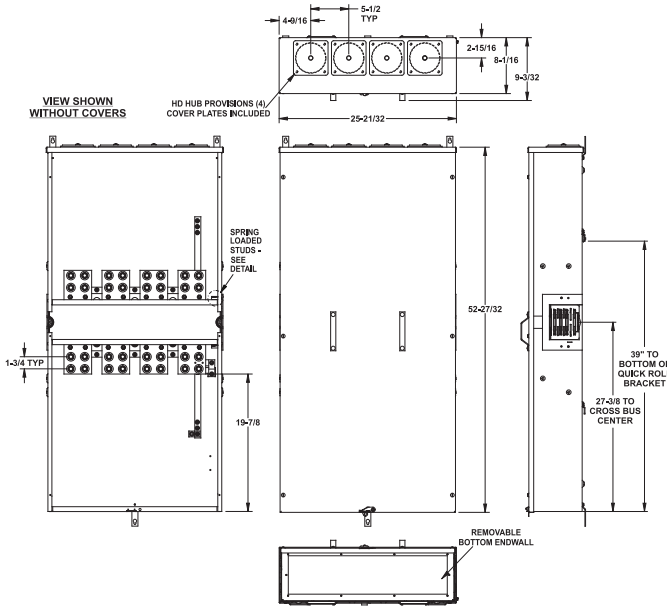

WTBN-3
WTBN3800CU

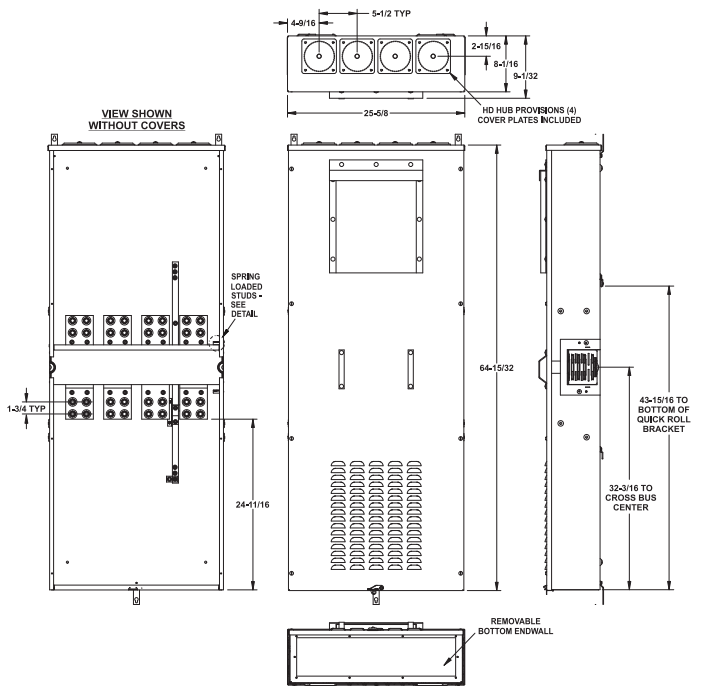

WTBN-4
WTBN31200CU

Power Mod



WMMB Aux Pull Box

Main Features:



- EUSERC compliant incoming pull section
- Dual cover handles
- Single and three phase models
- No horizontal bus
- EUSERC drawing number 343 and 347



EUSERC compliant pullbox modules: 1-phase, 3-wire SN, incoming, 120/240V AC max. ③

Catalog number	Ampere rating	Withstand rating ^②	Service feed	Dimensions (inches) ^①			KO drawing no.	Line terminal lugs no. and size per line and neutral	Knockout Diagrams
				Height	Width	Depth			
WMMB1400	400	65,000	UG	37.50	16.69	9.34	P-1	1 set of 2 studs 	P-1
WMMB1800	800	65,000	UG	45.50	19.44	12.72	P-2	1 set of 2 studs 	P-2
WMMB11200	1200	65,000	UG	47.50	25.94	12.72	P-3	3 sets of 2 studs 	P-3

EUSERC compliant pullbox modules: 3-phase, 4-wire SN, incoming, 240V AC max. ③

Catalog number	Ampere rating	Withstand rating ^②	Service feed	Dimensions (inches) ^①			KO drawing no.	Line terminal lugs no. and size per line and neutral	Knockout Diagrams
				Height	Width	Depth			
WMMB3400	400	65,000	UG	37.50	16.69	9.34	P-1	1 set of 2 studs 	P-1
WMMB3800	800	65,000	UG	45.50	25.94	12.72	P-2	2 set of 2 studs 	P-2
WMMB31200	1200	65,000	UG	47.50	33.83	12.72	P-3	3 sets of 2 studs 	P-3

Please Note: As of 4/10/2019 the **WMMB** modules no longer come with the pass through bushing. If it is required please order it as a separate part. The pass through bushing part number is **WMMBK**

① Dimensions shown are representative of outside box dimensions and do not include allowances for mounting bumps, endwalls, covers, hubs, or hardware protrusions. Dimensions are subject to change.

② Devices rated for 22,000. 65,000 rating requires cables to be tied together. Please see instructions with pullbox for details.

③ Devices do not have horizontal bus.

Power Mod

WMMB Aux Pull Box: Knockout Diagrams

3
METER
CENTERS

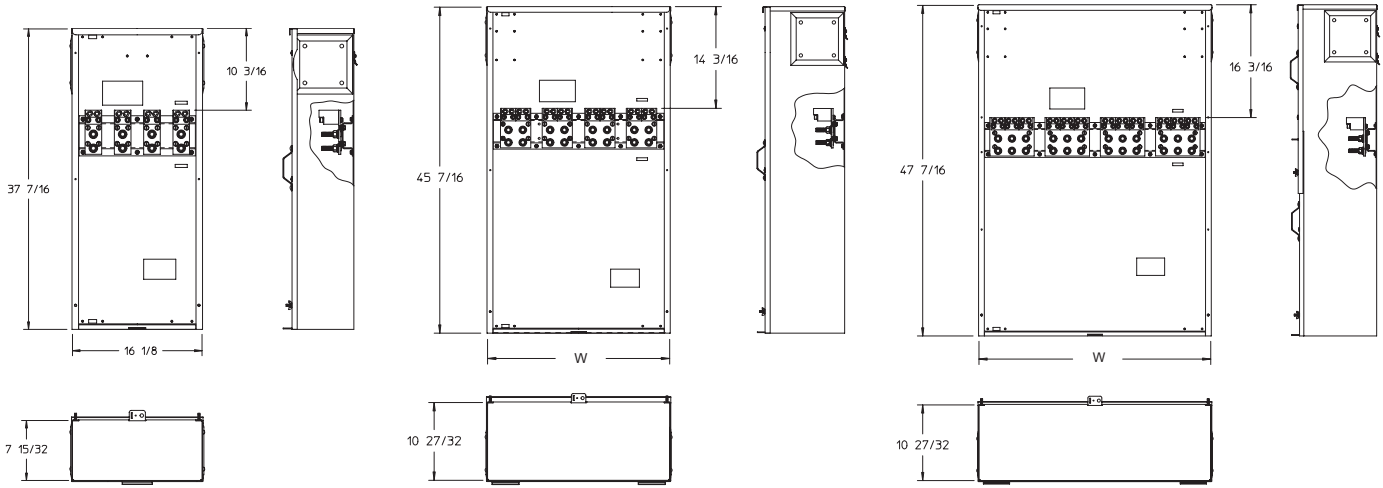

P-1	
WMMB1400	
WMMB3400	

P-2	
	Width
WMMB1800	19.44
WMMB3800	25.94

P-3	
	Width
WMMB11200	25.94
WMMB31200	33.83

Power Mod

Elbows and Spacers

Elbows and Spacers

Siemens offers a wide range of auxiliary modules to help product fit your application. All units come with appropriate hardware and instruction sheets for safe installation.

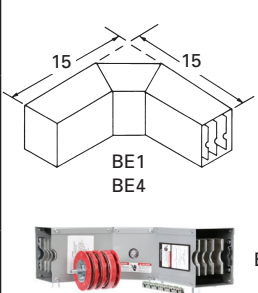
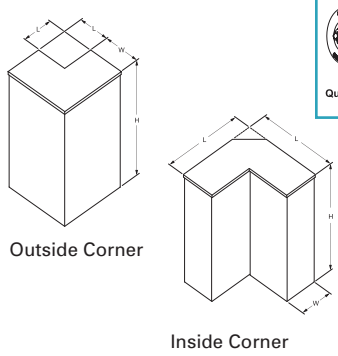
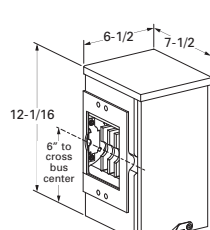

Bussed Elbow and Bussed Extensions/Spacers

	Catalog number	Description	Dimensions (inches) ^①		
			Height	Length	Width
NEMA 1 Elbows 	BE1 ^②	Indoor Bussed Elbow, 15", 1-phase, 3-wire, 1200 Amp maximum	5.62	15.06	4.87
	BE4 ^②	Indoor Bussed Elbow, 15", 3-phase, 4-wire, 1200 Amp maximum	5.62	15.06	4.87
	BE112 ^②	Indoor Bussed Elbow, 12", 1-phase, 3-wire, 1200 Amp maximum	5.62	12.09	4.87
	BE412 ^②	Indoor Bussed Elbow, 12", 3-phase, 4-wire, 1200 Amp maximum	5.62	12.09	4.87
NEMA 3R Elbows 	WELB318	Outdoor Elbow, Inside corner, 3-phase, 100k max AIC	30.06	18.31	7.97
	WELB118	Outdoor Elbow, Inside corner, 1-Phase, 100k max AIC	30.06	18.31	7.97
	WELB312	Outdoor Elbow, Inside corner, 3-phase, 100k max AIC	30.06	12.31	7.97
	WELB112	Outdoor Elbow, Inside corner, 1-Phase, 100k max AIC	30.06	12.31	7.97
	WELB307E	Outdoor Elbow, Outside corner, 3-phase, 100k max AIC	30.06	6.80	7.97
	WELB107E	Outdoor Elbow, Outside corner, 1-Phase, 100k max AIC	30.06	6.80	7.97
Bussed Extensions/Spacers 	WSP1	Outdoor Bussed Extension, 1-phase, 3-wire, 1200 Amp maximum	12.06	7.25	6.50
	WSP3	Outdoor Bussed Extension, 3-phase, 4-wire, 1200 Amp maximum	12.06	7.25	6.50

① Dimensions shown are representative of outside box dimensions and do not include allowances for mounting bumps, endwalls, covers, hubs, or hardware protrusions. Dimensions are subject to change.

② Do not connect indoor elbows directly to busway.

Uni-PAK

Uni-PAK Metering: Introduction

General Information

Siemens Uni-PAK Metering offers maximum flexibility and ease of installation to meet the service requirements of multiple position metering projects. The outdoor/indoor devices are available in two through six gang set-ups which consist of a pull section with main lugs or stud terminations, and 4/5 jaw meter sockets with tenant circuit breaker provisions.

Features include:

- Siemens exclusive 200 ampere/position feature the QS breaker for faster / easier installation
- Removable knock-out plate for back exit
- Mounting rail for wall hanging - Siemens Exclusive
- UL Listed for use with 60/75C degree wire
- Outdoor/indoor construction
- Overhead or underground service; load top, bottom or back

Standard Uni-Pak Quick Reference

- ANSI - Standard #C 12.7-1987
- NEMA - Standard #250-1985
- UL - File #E27100
- UL - Standard #50, 67,414
- Voltage 240V AC Maximum
- 125 amp or 200 amp Maximum per position
- 1000 Amps maximum bus
- 2-6 positions

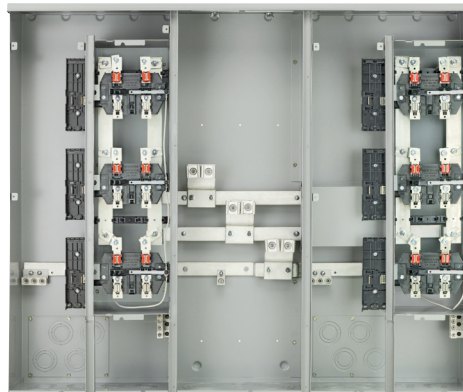
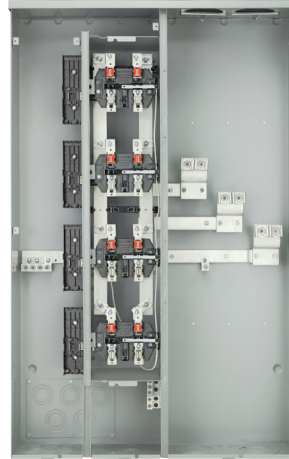

Uni-PAK

Uni-PAK Metering: Introduction

Uni-PAK Construction



Sturdy Steel Base Pan
Provides reinforcing durable support for each tenant main breaker.



Handle
available on larger devices to make lifting the unit easier.

Line Lugs Factory Installed (WP, WEP, WPC)



2 Pole up to 225A @100kAIC
Fits in 2 inch – compact width reduces enclosure size limiting total mounting space required.

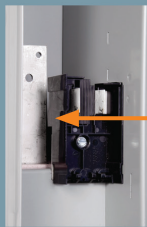

Rigid Molded Side Wall
Provides reinforcing vertical support for each tenant main breaker.



Main Breaker Retainer
Ensures secure connection for breaker wiring.

125 amp breakers can go into 225 amp positions without conversion kits.



Barrel Lock Capable Covers
Accepts common utility barrel locks to protect against unauthorized usage.



Lockable Breaker Cover

1 Extra Neutral And Ground Termination

Top And Bottom Exit

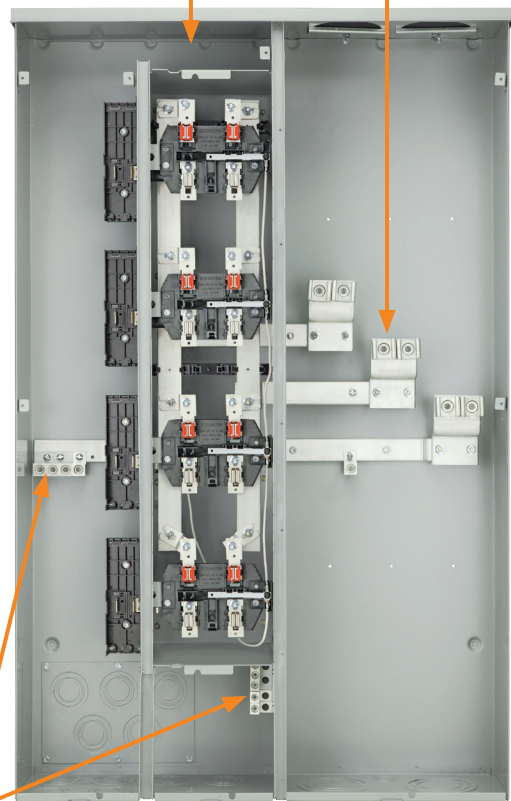

Uni-PAK

Uni-PAK Metering: Introduction

Uni-PAK Features and Benefits

Mounting Rail

Simplified mounting by using a separate rail to hang the device. (Please Note: a mounting rail is not applicable for two position 125A WP and WEP devices)

5Th Jaw Option

Located in 6 or 9 o'clock position. Factory or field installed

Horn Bypass Option

Factory or field installed.

Front Accessible Connections

All connections use similar hardware and use Belleville washers for tight connections.

Ring Or Ringless Covers

Individual ring or ringless type meter covers. Ring to ringless kits available to make last minute cover changes for specified utility requirements.

Apartment No. Emboss

Provides convenience and organization.

Removable Back End KO Plate

Simplifies and speeds up pulling wire. Entire plate can be removed to allow ample space for wire. Knockouts in the plate can be removed before or after stack installation.

More Features

- 1) Large range of ampacities 200- 1000A
- 2) 125 amp continuous duty sockets feed plug-in tenant breakers through 125 Amps
- 3) 200 amp continuous duty sockets feed plug-in tenant breakers through 225 Amps
- 4) UL Listed for short circuit ratings up to 100,000 RMS symmetrical Amps at 240V AC
- 5) Lever Bypass models available
- 6) EUSERC compliant models available
- 7) 2 - 6 number of meter positions
- 8) Outdoor/indoor construction
- 9) Overhead or underground service; load top, bottom or back
- 10) Compact design for ease of handling and installation
- 11) All unmetred bus is barriered and sealable to prevent unauthorized access.
- 12) Electrodeposited paint provides uniform coverage for long-lasting protection and sharp appearance
- 13) Complies with the following industry standards
 - ANSI - Standard # C 12.7-1987
 - NEMA - Standard #250-1985
 - UL - File #E10703
 - UL - Standard#50, 67, 414

Rain Channel

Rotates out of the way for easy KO access

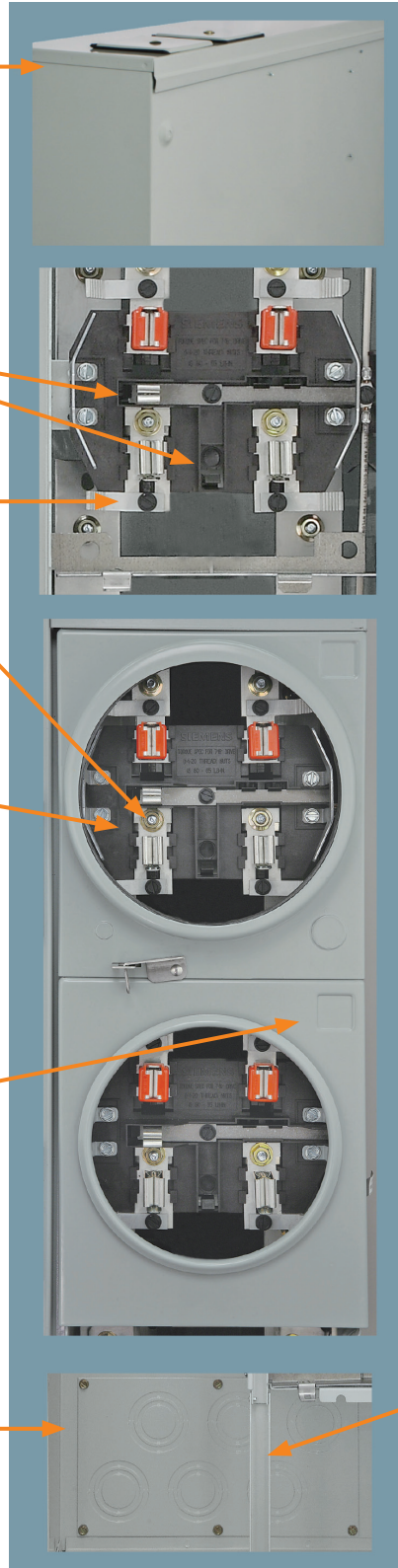

Uni-PAK

Uni-PAK Metering: WP Ring Style

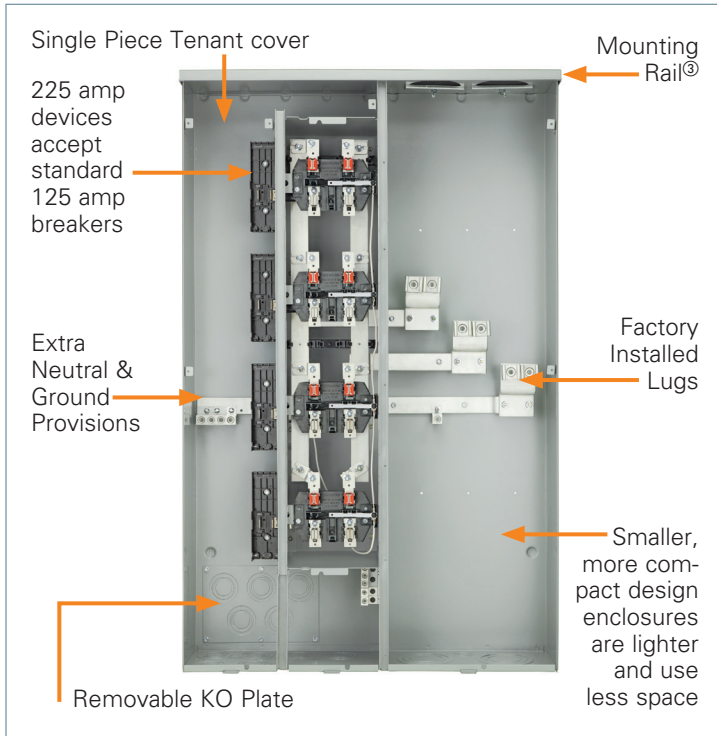

Features

- Individual split covers
- Ring style meter construction
- UL Listed for 60 / 75°C conductors. See equipment markings for applications
- For small apartment buildings, small professional and commercial buildings
- Completely self-contained meter centers
- Two to six 125A and 225A sockets breaker positions
- Outdoor surface mounted enclosures
- Compact, pre-bussed, easy to handle, hang and wire
- Barriercd, sealable compartment for unmetered current-carrying parts
- Al/Cu lay-in lugs, except two position 125A units
- Top or bottom feed
- Bottom and rear branch wiring exits (Neutral and ground at bottom only)
- ANSI #61 light gray electrodeposited paint on G90 galvanized steel
- Field installable 5th jaw kit

3 METER CENTERS

Ring Style Uni-PAK 120/240V 1 Phase, 3 Wire

Maximum Tenant Main	Bus Amperage	Meter Positions Per Pak	Catalog Number	Breaker Provision	Max. AIC	Dimensions ^①			5th Jaw Assembly	Line Lugs Wire Range
						Height	Width	Depth		
125	200	2	WP2211 ^③	QP, QPH, HQP, MP-T, MP-HT, MP-MT	65,000	26.26	13.80	5.81	ECMF5 6:00 or 9:00	#6-300 kcmil
	300	3	WP3311			38.75				25.42
	400	4	WP4411			47.75	38.95			
		5	WP4611			38.75				26.47
	500	4	WP5411			47.75	39.01			
	600	5	WP6511			38.75	40.01			
225	400	2	WP4212	QP, QPH, HQP, MP-T, MP-HT, MP-MT, QS, QSHH, HQS, HQSH	100,000	29.75	28.53	7.56	ECMF5 6:00 or 9:00	1/0-750 kcmil CU-AL or (2) 1/0-250 AL or (2) 1/0-3/0 CU
		3	WP4312			38.75				29.59
	4	4	WP4412			47.75	46.22			
		5	WP6412			38.75				51.03
	600	5	WP6512				WP6612			
	800	6	WP8612			WP10612				
		1000								

Uni-PAK Alternate Lug Kits (WP ONLY) ^②	
WPLK2400	400A Bus Lug Kit (2) #4-250
WPLK2600	600A Bus Lug Kit (3) #6-250

Replacement Factory Installed Lug Kits (WP & WEP Only)	
ECMLK3225	300 KCMIL - For use in devices with 200A rated bus (contains 1 lug assembly)
WPRLK600	600 KCMIL - For use in devices with 300A, 500A, 600A or 1000A rated bus (contains 1 lug assembly)
WPRLK750	750 KCMIL - For use in devices with 400A or 800A rated bus (contains 1 lug assembly)

① Dimensions shown are representative of outside box dimensions and do not include allowances for mounting

bumps, endwalls, covers, hubs, or hardware protrusions. Dimensions are subject to change.

② Designed for GA Power. Not limited thereto.

③ Mounting Rails are not applicable for two position 125A WP and WEP devices. These units are light enough to be mounted using the back wall mounting dimples.

Uni-PAK

Uni-PAK Metering: WP Ringless Style, No Bypass

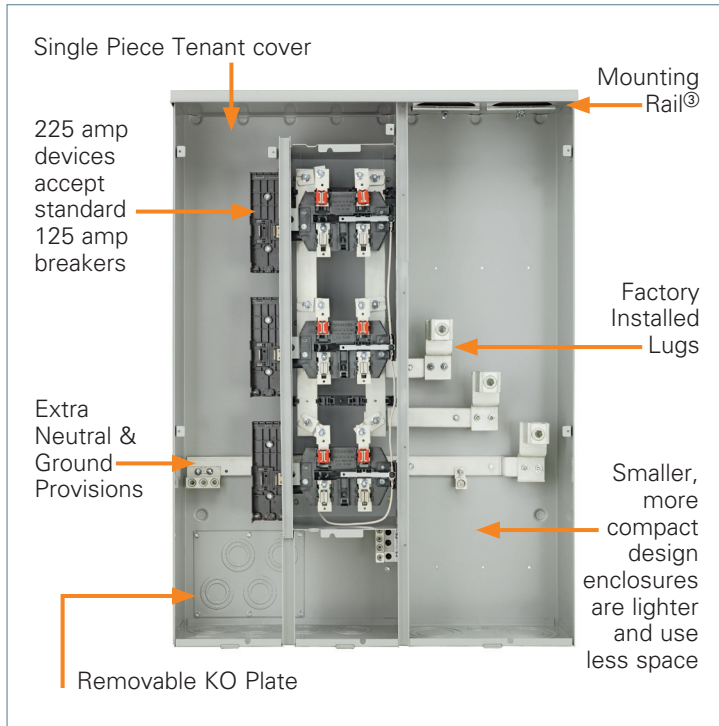

Features

- Ringless meter construction
- Individual split covers with barrel lock compatibility
- Available with horn bypass factory installed
- UL Listed for 60/75°C conductors See equipment markings for applications
- For small apartment buildings, small professional and commercial buildings
- Completely self-contained meter centers
- Two to six 125A and 225A breaker positions
- Compact, pre-bussed, easy to handle, hang and wire
- Barriercd, sealable compartment for unmetered current-carrying parts
- Al/Cu lay-in lugs, except two position 125A units
- Top or bottom feed
- Bottom and rear branch wiring exits (Neutral and ground at bottom only)
- ANSI #61 light gray electrodeposited paint on G90 galvanized steel
- 5th jaw kit included with each unit
- Outdoor surface mounted enclosures

Ringless Style Uni-PAK 120/240V 1 Phase, 3 Wire

Max. Tenant Main	Bus Amperage	Meter Positions Per Pak	Catalog Number	Breaker Provision	Max. AIC	Dimensions ^①			5th Jaw Assembly	Horn Bypass Kit	Line Lugs Wire Range
						Height	Width	Depth			

No Bypass

125	200	2	WP2211RJ ^③	QP, QPH, HQP, MP-T, MP-HT, MP-MT	65,000	26.26	13.80	5.81	INCL. 9:00 factory 6:00 field	ECMFH	#6-300 kcmil	
	300	3	WP3311RJ			38.75	25.42	#2-600 kcmil				
	400	4	WP4411RJ			47.75	38.95	1/0-750 kcmil CU-AL or (2) 1/0-250 AL or (2) 1/0-3/0 CU				
		5	WP4511RJ			38.75						
	500	4	WP5411RJ			47.75	26.47	(2) #2-600 kcmil				
	600	5	WP6511RJ			38.75	39.01					
6		WP6611RJ	40.01									
225	400	2	WP4212RJ	QP, QPH, HQP, MP-T, MP-HT, MP-MT, QS, QSH, QSHH, HQS, HQSH	100,000	29.75	28.53	7.56	INCL. 9:00 factory 6:00 field	ECMFH	1/0-750 kcmil CU-AL or (2) 1/0-250 AL or (2) 1/0-3/0 CU	
		3	WP4312RJ			38.75						
		4	WP4412RJ			47.75						29.59
	600	5	WP6512RJ			46.22	38.75				51.03	(2) #2-600 kcmil
		6	WP6612RJ									
	800	6	WP8612RJ								(2) 1/0-750 kcmil or (4) 1/0-250 AL or (4) 1/0-3/0 CU	
1000		WP10612RJ			(3) #2-500 kcmil							

Uni-PAK Alternate Lug Kits (WP ONLY) ^②	
WPLK2400	400A Bus Lug Kit (2) #4-250
WPLK2600	600A Bus Lug Kit (3) #6-250

Replacement Factory Installed Lug Kits (WP & WEP Only)	
ECMLK3225	300 KCMIL - For use in devices with 200A rated bus (contains 1 lug assembly)
WPRLK600	600 KCMIL - For use in devices with 300A, 500A, 600A or 1000A rated bus (contains 1 lug assembly)
WPRLK750	750 KCMIL - For use in devices with 400A or 800A rated bus (contains 1 lug assembly)

① Dimensions shown are representative of outside box dimensions and do not include allowances for mounting

bumps, endwalls, covers, hubs, or hardware protrusions. Dimensions are subject to change.
 ② Designed for GA Power. Not limited thereto.

③ Mounting Rails are not applicable for two position 125 WP and WEP devices. These units are light enough to be mounted using the back wall mounting dimples.

Uni-PAK

Uni-PAK Metering: WP Ringless Style, Horn Bypass

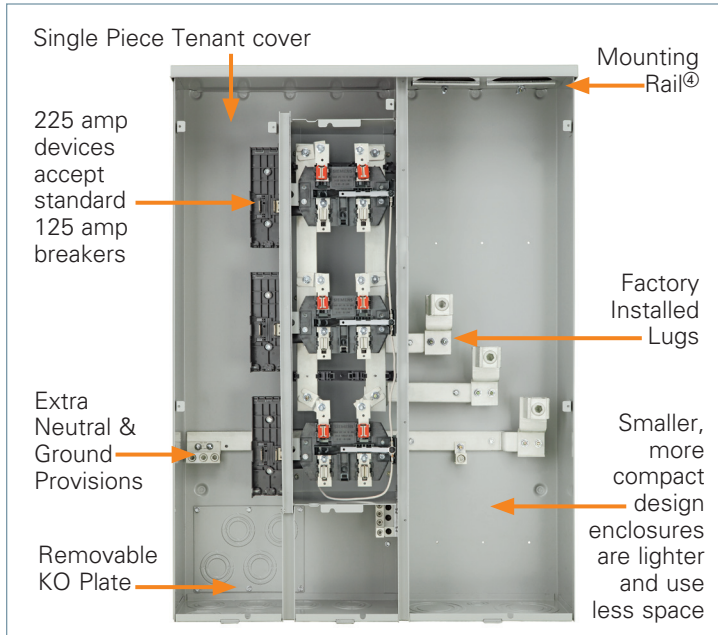

Features

- Ringless meter construction
- Individual split covers with barrel lock compatibility
- Horn bypass factory installed
- UL Listed for 60/75°C conductors See equipment markings for applications
- For small apartment buildings, small professional and commercial buildings
- Completely self-contained meter centers
- Two to six 125A and 225A breaker positions
- Barriercd, sealable compartment for unmetered current-carrying parts
- Al/Cu lay-in lugs, except two position 125A units
- Top or bottom feed
- Bottom and rear branch wiring exits (Neutral and ground at bottom only)
- ANSI #61 light gray electrodeposited paint on G90 galvanized steel
- 5th jaw kit included with each unit
- Outdoor surface mounted enclosures

METER CENTERS

Ringless Style Uni-PAK 120/240V 1 Phase, 3 Wire

Max. Tenant Main	Bus Amperage	Meter Positions Per Pak	Catalog Number	Breaker Provision	Max. AIC	Dimensions ^①			5th Jaw Assembly	Line Lugs Wire Range
						Height	Width	Depth		

Horn Bypass

125	200	2	WP2211RJJB ^④	QP, QPH, HQP, MP-T, MP-HT, MP-MT	65,000	26.26	13.80	5.81	INCL. 9:00 factory 6:00 field	#6-300 kcmil	
	300	3	WP3311RJJB			38.75				25.42	#2-600 kcmil
	400	4	WP4411RJJB			47.75					1/0-750 kcmil CU-AL or (2) 1/0-250 AL or (2) 1/0-3/0 CU
	400	5	WP4511RJJB			38.75	38.95			(2) #2-600 kcmil	
	500	4	WP5411RJJB			47.75	26.47				
	600	5	WP6511RJJB			38.75	40.00				
225	400	2	WP4212RJJB	QP, QPH, HQP, MP-T, MP-HT, MP-MT, QS, QSH, QSHH, HQS, HQSH	100,000	29.75	28.53	7.56	INCL. 9:00 factory 6:00 field	1/0-750 kcmil CU-AL or (2) 1/0-250 AL or (2) 1/0-3/0 CU	
		3	WP4312RJJB			38.75				29.59	(2) #2-600 kcmil
	4	WP6412RJJB	47.75								
	600	5	WP6512RJJB			38.75	46.22			(2) 1/0-750 kcmil or (4) 1/0-250 AL or (4) 1/0-3/0 CU	
		6	WP6612RJJB								
	800	6	WP8612RJJB			51.03				(3) #2-500 kcmil	
	1000	6	WP10612RJJB								

Horn Bypass, Alternate Enclosure Size and Lug Configuration^③

125	200	2	WPC2211RJJB ^④	QP, QPH, HQP, MP-T, MP-HT, MP-MT	65,000	32.53	13.80	5.81	INCL. 9:00 factory 6:00 field	#6-300 kcmil
225	400	2	WPC4212RJJB	QP, QPH, HQP, MP-T, MP-HT, MP-MT, QS, QSH, QSHH, HQS, HQSH	100,000	29.75	28.53	7.56		#6-350 kcmil
225	400	3	WPC4312RJJB	100,000	38.75					

Uni-PAK Alternate Lug Kits (WP ONLY) ^②	
WPLK2400	400A Bus Lug Kit (2) #4-250
WPLK2600	600A Bus Lug Kit (3) #6-250

Replacement Factory Installed Lug Kits (WP & WEP Only)	
ECMLK3225	300 KCMIL - For use in devices with 200A rated bus (contains 1 lug assembly)
WPRLK600	600 KCMIL - For use in devices with 300A, 500A, 600A or 1000A rated bus (contains 1 lug assembly)
WPRLK750	750 KCMIL - For use in devices with 400A or 800A rated bus (contains 1 lug assembly)

① Dimensions shown are representative of outside box dimensions and do not include allowances for mounting bumps, endwalls, covers, hubs, or hardware protrusions.

② Dimensions are subject to change.
 ③ Designed for GA Power. Not limited thereto.
 ④ Designed for use with Alliant Energy. Not limited thereto.

⑤ Mounting Rails are not applicable for two position 125A WP and WEP devices. These units are light enough to be mounted using the back wall mounting dimples.

Uni-PAK

Uni-PAK Metering: WEP Ringstyle EUSERC

3
METER
CENTERS

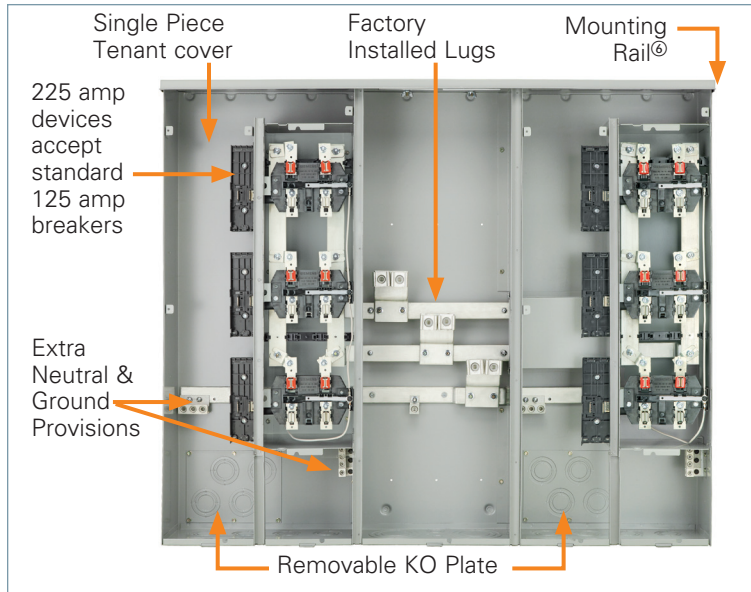

Features

- Individual split covers
- UL Listed for 60 / 75°C conductors. See equipment markings for applications
- Completely self-contained meter centers
- Outdoor surface mounted enclosures
- Semi flush with applicable field installed kit
- Barriercd, sealable compartment for unmeterecd current-carrying parts
- Al/Cu lay-in lugs, except two socket units
- Top or bottom feed
- Bottom and rear branch wiring exits (Neutral and ground at bottom only)
- Meets EUSERC specifications when NEMA stud kit and flushing ring (if required) is field added. Compression lugs, if required, are sold separately.

EUSERC Compliant Ring Style Uni-PAK 120/240V 1 Phase, 3 Wire

Max. Tenant Main	Bus Amperage	Meter Positions Per Pak	Catalog Number	Breaker Provision	Max. AIC	Dimensions ^①			5th Jaw Assembly	Line Lugs Wire Range	Semi-Flush Kit #	EUSERC Drawing #342 ^②
						Height	Width	Depth				
125	200	2	WEP2211 ^⑥	QP, QPH, HQP, MP-T, MP-HT, MP-MT	65,000	32.52	13.80	7.56	ECMF5 6:00 or 9:00	#6-300 kcmil	WPFK1	figure 1
	300	3	WEP3311			38.75				#2-600 kcmil	WPFK2	
	400	4	WEP4411			47.75	25.42			1/0-750 kcmil CU-AL or (2) 1/0-250 AL or (2) 1/0-3/0 CU	WPFK3	
		5	WEP4511			38.75	38.94			(2) #2-600 kcmil	WPFK4	
	500	4	WEP5411			47.75	31.28				WPFK5	
	600	6	WEP4611			38.75	44.82					
225	400	2	WEP4212	QP, QPH, HQP, MP-T, MP-HT, MP-MT, QS, QSH, QSHH, HQS, HQSH	100,000	29.75	28.53	7.56	ECMF5 6:00 or 9:00	1/0-750 kcmil CU-AL or (2) 1/0-250 AL or (2) 1/0-3/0 CU	WPFK6	figure 2
		3	WEP4312			38.75				WPFK7		
	600	4	WEP4412			47.75	34.41			(2) #2-600 kcmil	WPFK8	figure 3
		5	WEP6412			38.75	51.04				WPFK9	
	800	6	WEP6512							(2) 1/0-750 kcmil or (4) 1/0-250 AL or (4) 1/0-3/0 CU	WPFK10	N/A
			WEP6612									
	1000	WEP8612 ^②	(3) #2-500 kcmil			WPFK11						
	WEP10612 ^②											

EUSERC Dual-amp Uni-PAK for EV Car Charger^{③④}

Max. Tenant Main	Bus Amperage	Meter Positions Per Pak	Catalog Number	Breaker Provision	Max. AIC	Dimensions ^①			5th Jaw Assembly	Line Lugs Wire Range
						Height	Width	Depth		
Position 1: 50A Position 2: 200A	200A	2	WEP2212EV ^⑤	QP, QPH, HQP, QS, QSH, QSHH, HQS, HQSH	65,000	32.47	16.25	6.03	ECMF5	300 kcmil - #4 AWG

NEMA Stud Kits (WEP Only)^⑤

Catalog Number	Amperage	Note
WPSK400	400A	fits 300-400
WPSK600	600A	fits 500-600
WPSK800	800A	—
WPSK1000	1000A	—

Replacement Factory Installed Lug Kits (WP & WEP Only)

ECMLK3225	300 KCMIL - For use in devices with 200A rated bus (contains 1 lug assembly)
WPRLK600	600 KCMIL - For use in devices with 300A, 500A, 600A or 1000A rated bus (contains 1 lug assembly)
WPRLK750	750 KCMIL - For use in devices with 400A or 800A rated bus (contains 1 lug assembly)

① Dimensions shown are representative of outside box dimensions and do not include allowances for mounting bumps, endwalls, covers, hubs, or hardware protrusions. Dimensions are subject to change.

② Please note the EUSERC standard currently only covers up to 600 amp devices. Please consult utility prior to installation.

③ Applies to EUSERC drawing #342.

④ Uni-PAK designed for EV car charger. Has separate meter for utility company to offer lower rate for power to EV charger (50A top position).

⑤ To be used with compression or mechanical lugs. Power Mod type LK_N2(E) lug kits can be used. View cutsheet for

specific lug kit options.

⑥ Mounting Rails are not applicable for two position 125A WP and WEP devices nor the EV device. These units are light enough to be mounted using the back wall mounting dimples.

Uni-PAK

Uni-PAK Metering: WPL Ringless Style, Lever Bypass

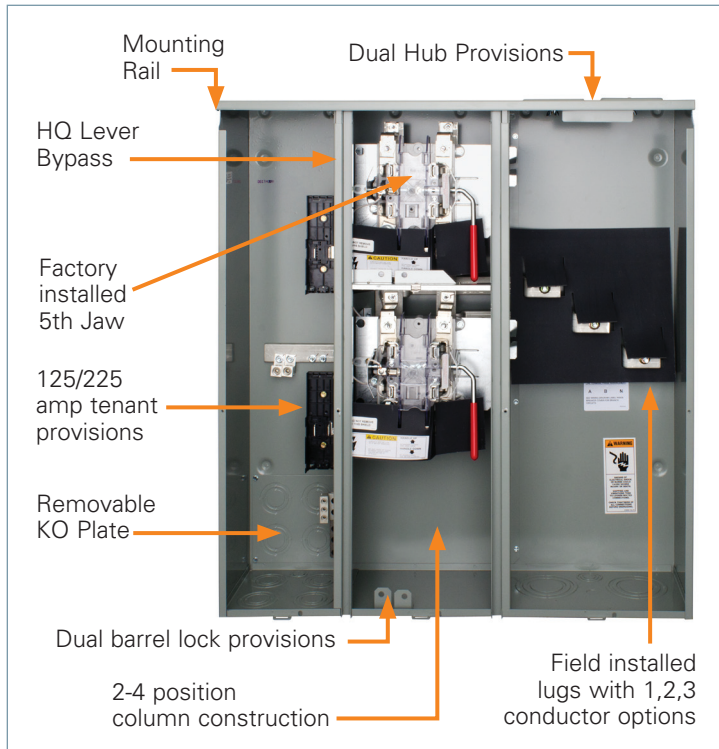

Features:

- Side mounted handles to help in lifting
- Provisions for one, two, or three incoming conductors per phase and neutral (lugs field installed)
- 225 amp branch tenant provisions @ 100,000 AIC
- Full line of 2-6 position devices
- Light and compact design
- Individual split cover
- UL Listed for 60/75 degrees C conductors. See equipment markings for applications
- For small apartment buildings, small professional and commercial buildings
- Completely self-contained meter centers
- Outdoor surface mounted enclosures
- Barriercd, sealable compartment for unmetered current-carrying parts
- Top or bottom fed
- Bottom and rear branch wiring exits (Neutral and ground at bottom only)
- ANSI #61 light gray electrodeposited paint on G90 galvanized steel.

Ringless Style Uni-PAK 120/240V 1 Phase, 3 Wire, Lever Bypass

Max. Tenant Main	Bus Amperage	Meter Positions Per Pak	Catalog Number	Breaker Provision	Max. AIC	Dimensions ^①			5th Jaw Assembly	Line Lugs Wire Range
						Height	Width	Depth		
225	400	2	WPL4212RJ	QP, QPH, HQP, MP-T, MP-HT, MP-MT, QS, QSH, QSHH, HQS, HQSH	100,000	36.88	33.72	9.84	INCL. 9:00 position	3/8" Stud – Field installed lugs ^②
		3	WPL4312RJ			49.88				
		4	WPL4412RJ WPL6412RJ			62.88				
	600	5	WPL6512RJ			49.75	53.56			
		6	WPL6612RJ				57.81			
			WPL8612RJ							
800	6	WPL8612RJ								
1000										

Lug Kits (WPL only)^②

Catalog Number	Wire Range
H56476	3/0-800 kcmil
H60162	(2) 1/0-250 kcmil OR (1) #4-600 kcmil
H68752-1	(3) #6-250 kcmil
H56732	(2) #4-350 kcmil
H56732-M	(2) #4-500 kcmil

^① Dimensions shown are representative of outside box dimensions and do not include allowances for mounting bumps, endwalls, covers, hubs, or hardware protrusions. Dimensions are subject to change.

^② Lug kits should be chosen based on the wire size being run to the unit. Wire should be sized according to the National Electrical Code. Lugs are sold separately. On 400-600A applications, a total of 3 lugs are required to wire the line side of the device. Lugs sold in packs of 2 pieces.

Uni-PAK

Uni-PAK Metering: Dimensional and Knockout Diagrams

WP2211

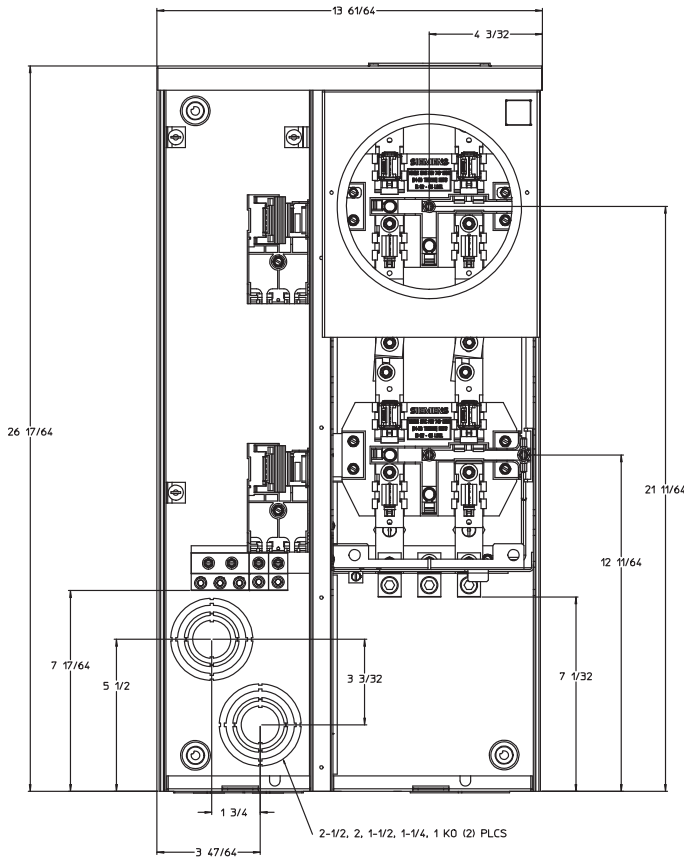

**Top view for
WP2211 and WEP2211**

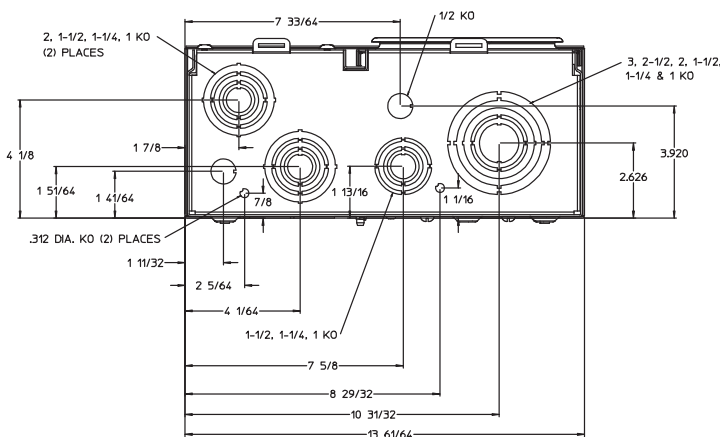
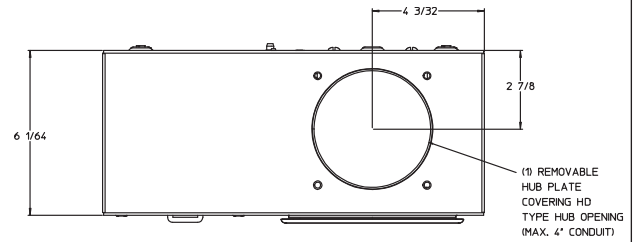

**Bottom view for
WP2211 and WEP2211**

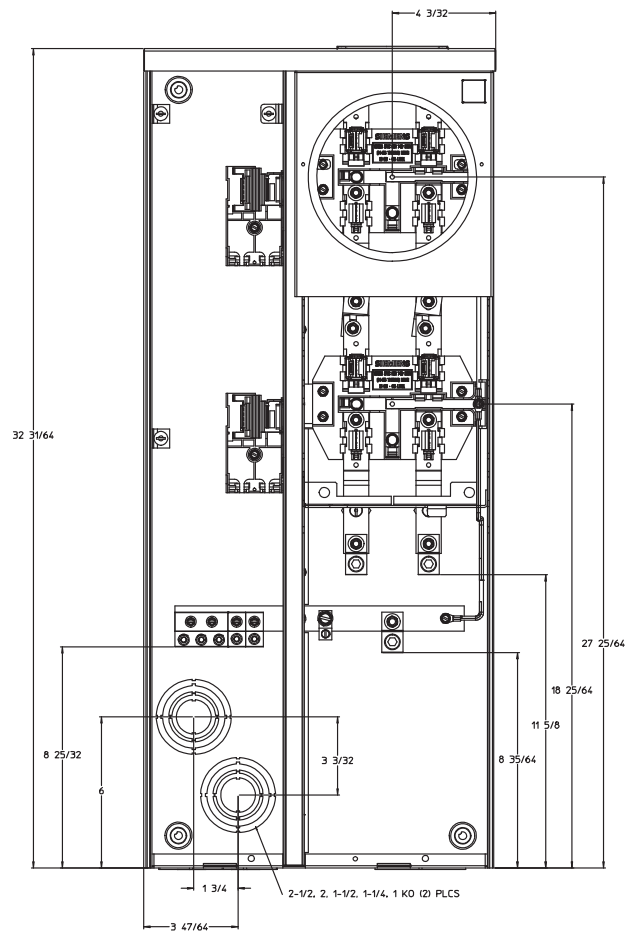

WEP2211

Uni-PAK

Uni-PAK Metering: Dimensional and Knockout Diagrams

WP3311 WEP3311

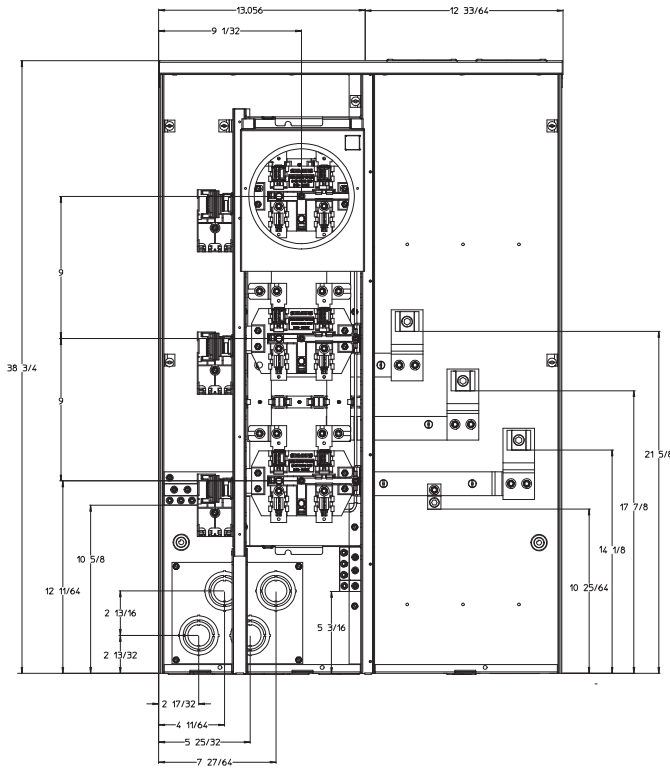

Top view for WP3311, WP4411, WEP3311 and WEP4411

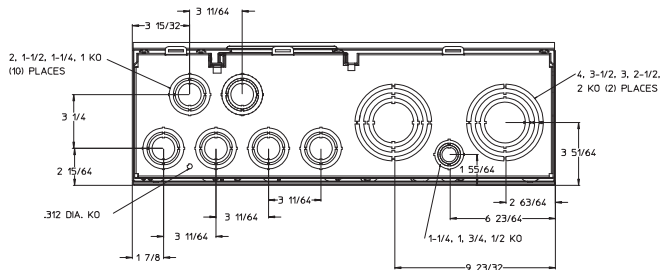
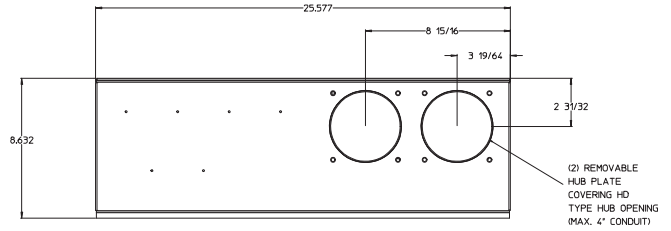

Bottom view for WP3311, WP4411, WEP3311 and WEP4411

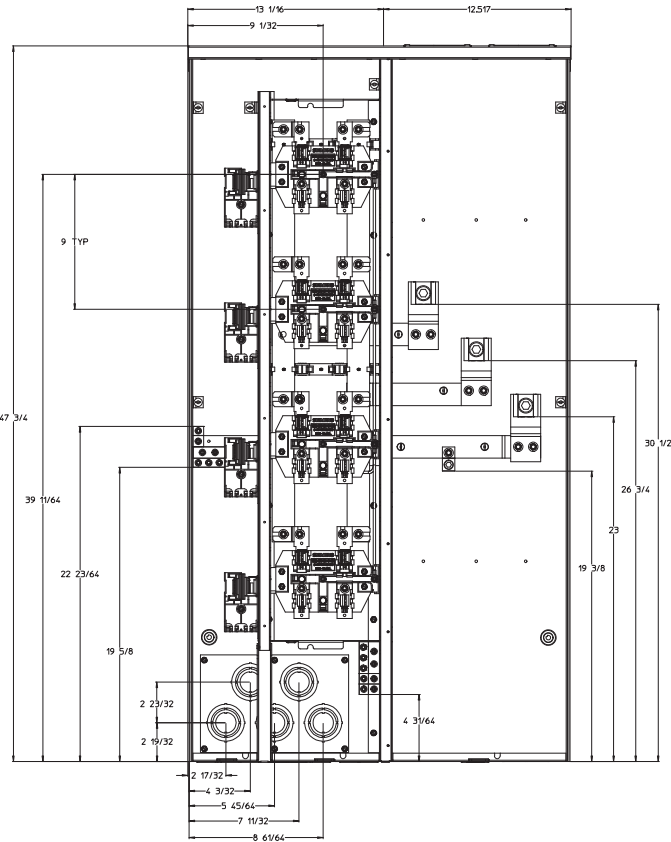

WP4411 WEP4411

Uni-PAK

Uni-PAK Metering: Dimensional and Knockout Diagrams

3
METER
CENTERS

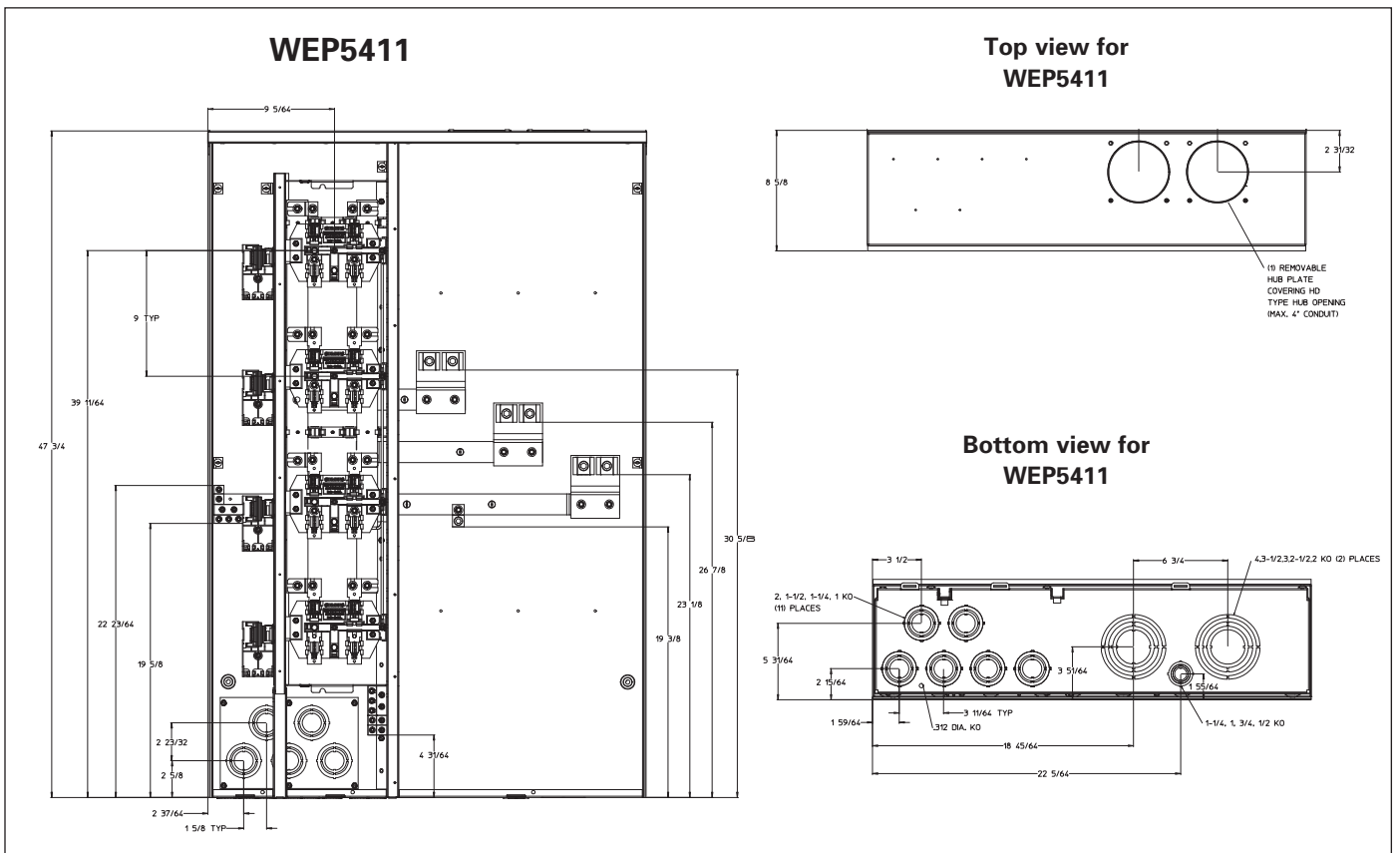
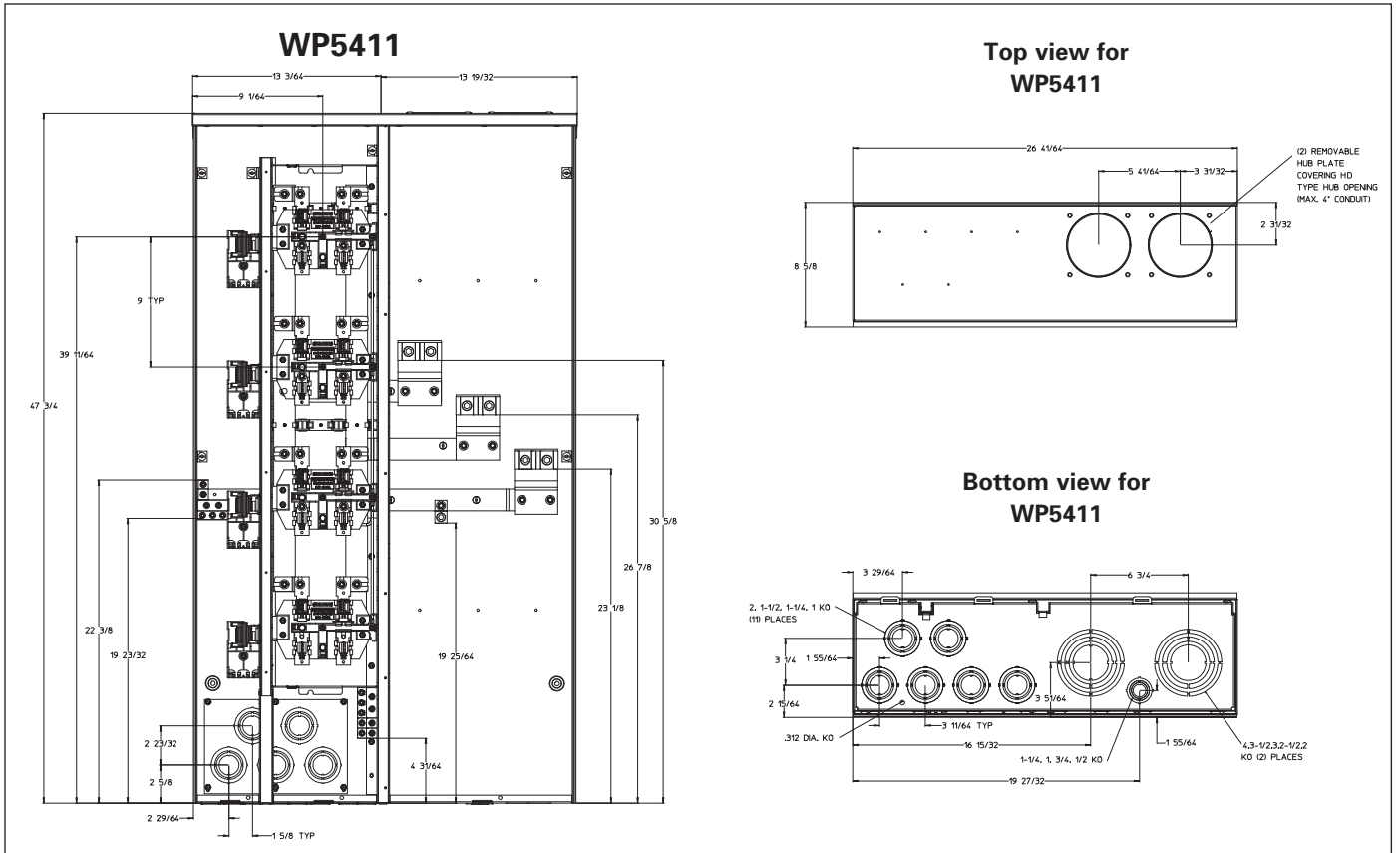

Uni-PAK

Uni-PAK Metering: Dimensional and Knockout Diagrams

WP4511 WEP4511

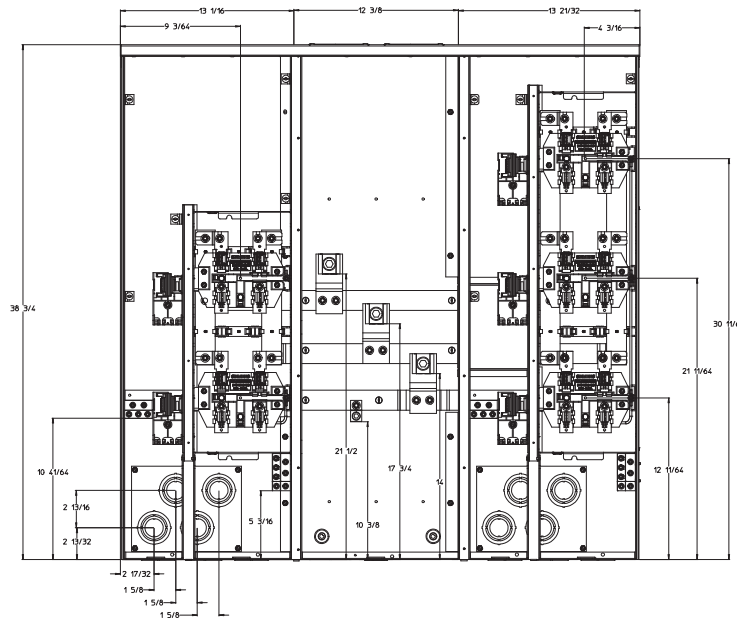

Bottom view for
WP4511, WP4611, WEP4511 and WEP4611

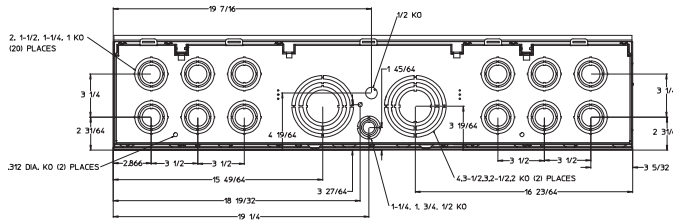

Top view for
WP4511, WP4611, WEP4511 and WEP4611

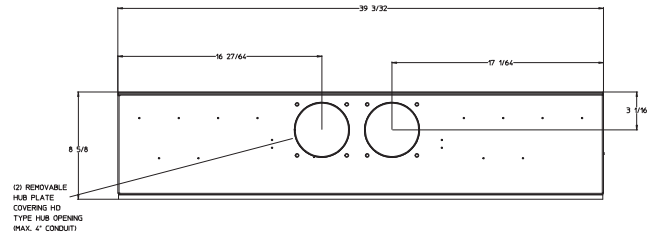

WP4611 WEP4611

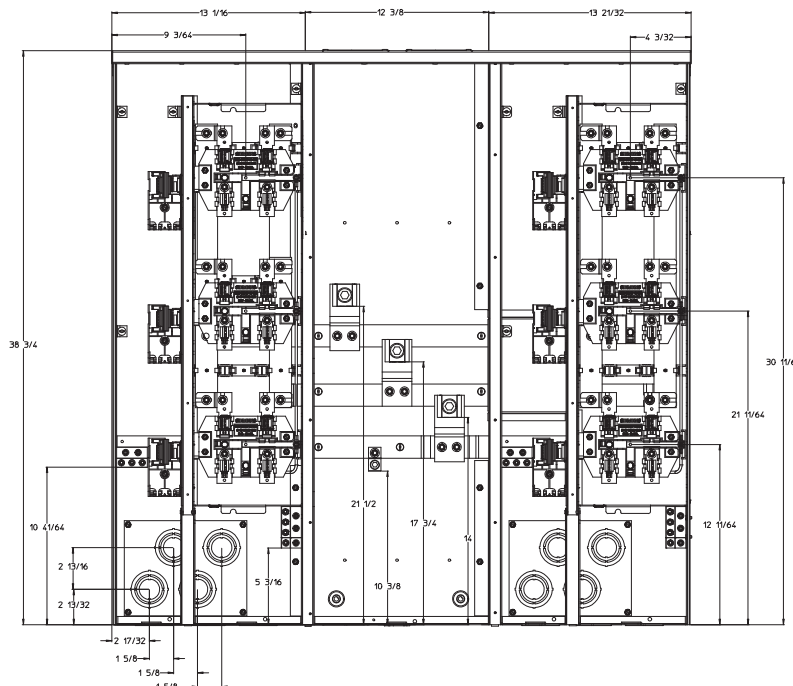

Uni-PAK

Uni-PAK Metering: Dimensional and Knockout Diagrams

WP6511

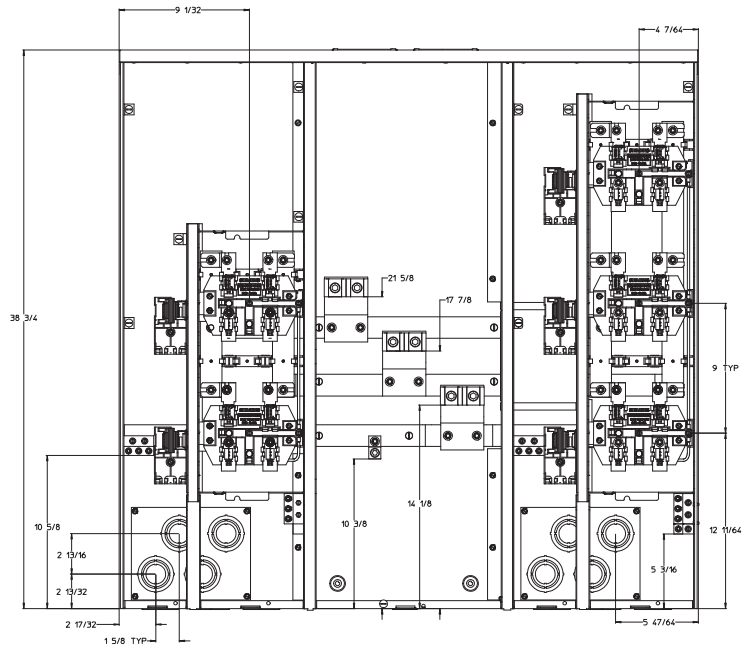

Top view for WP6511 and WP6611

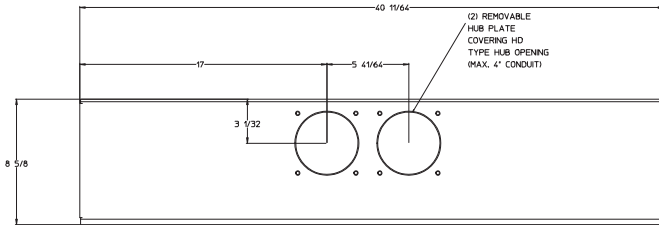

Bottom view for WP6511 and WP6611

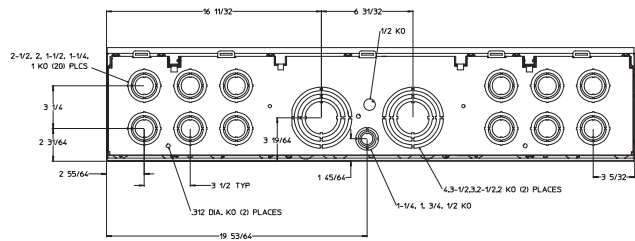

WP6611

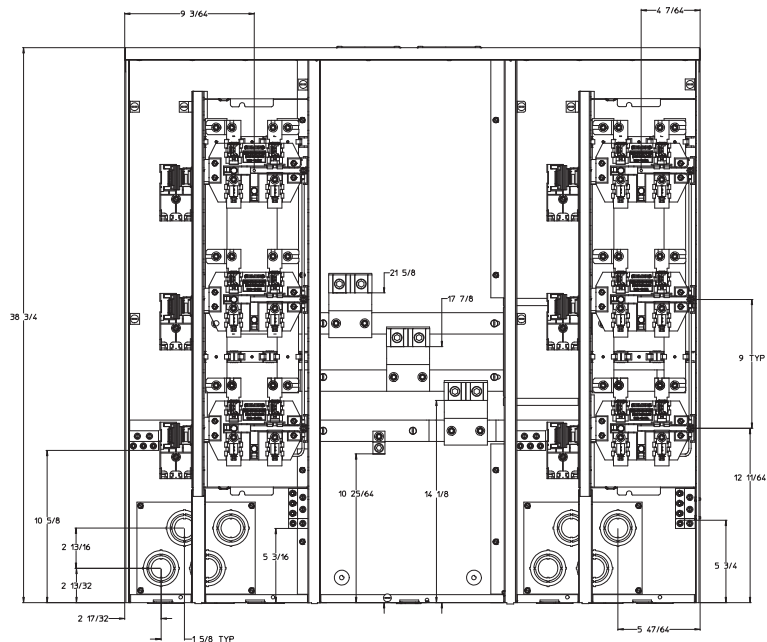

Uni-PAK

Uni-PAK Metering: Dimensional and Knockout Diagrams

WEP6511

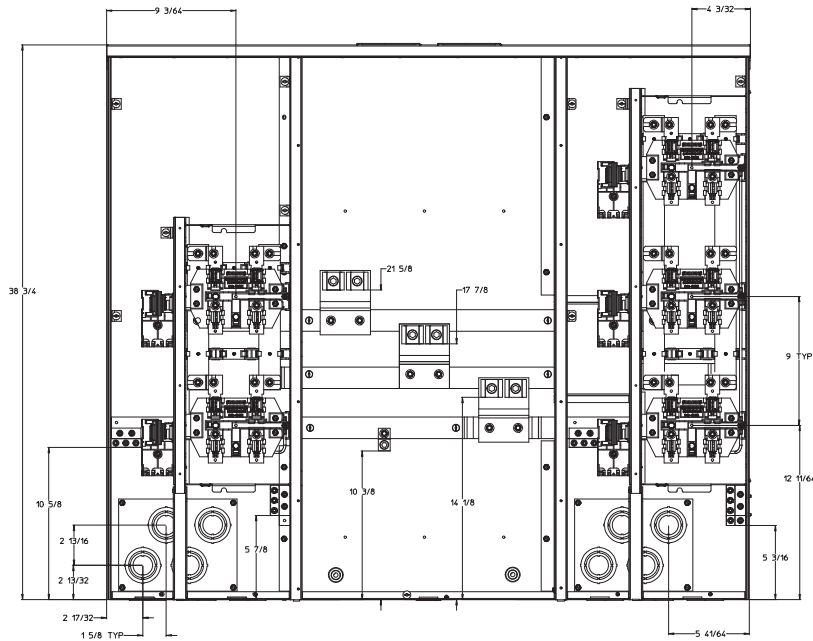

Top view for WEP6511 and WEP6611

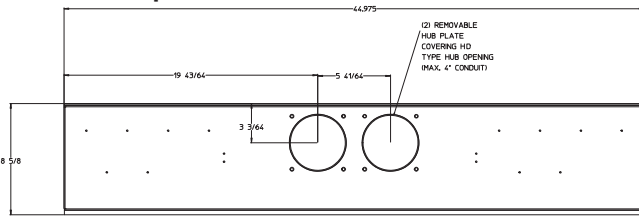

Bottom view for WEP6511 and WEP6611

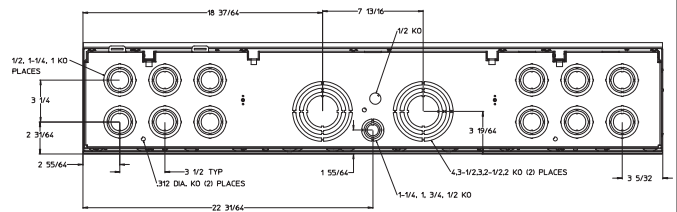

WEP6611

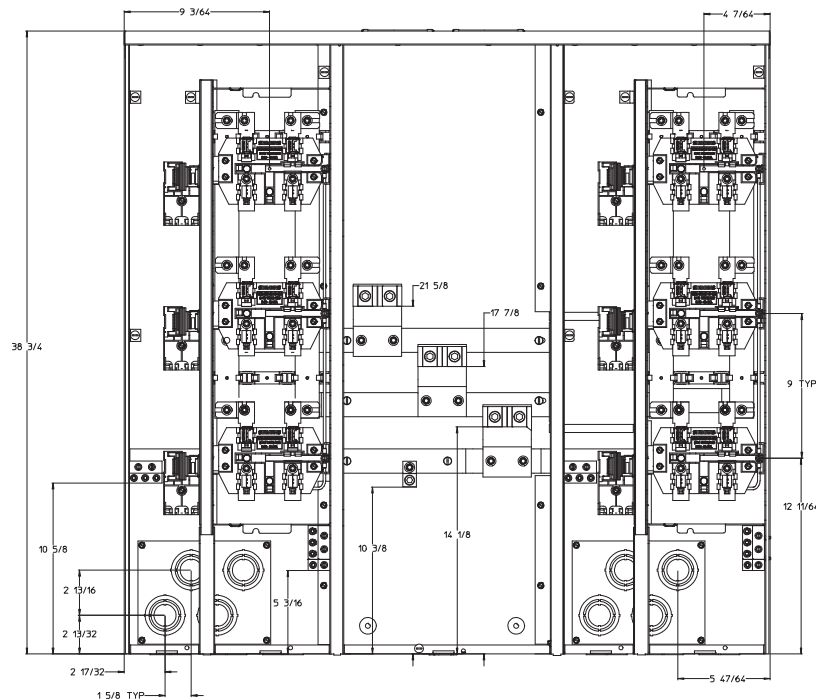

Uni-PAK

Uni-PAK Metering: Dimensional and Knockout Diagrams

WP4212 WEP4212

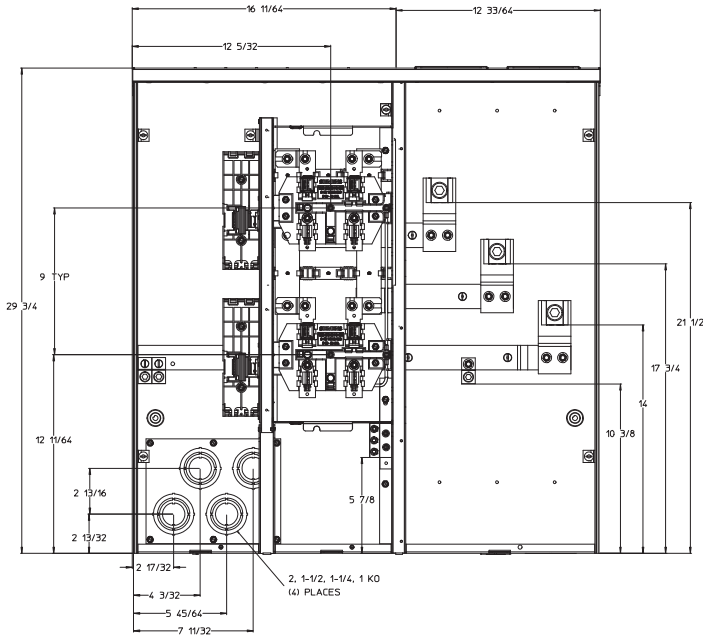

Top view for WP4212, WEP4212, WP4312 and WEP4312

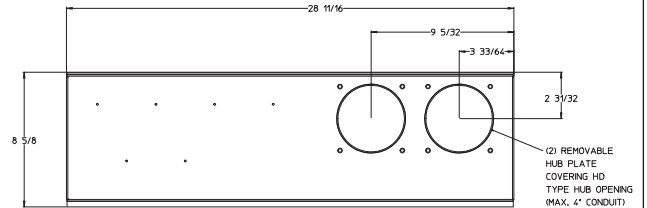

3
METER
CENTERS

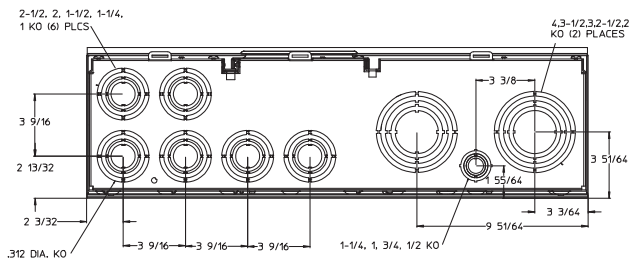

Bottom view for WP4212, WEP4212, WP4312 and WEP4312

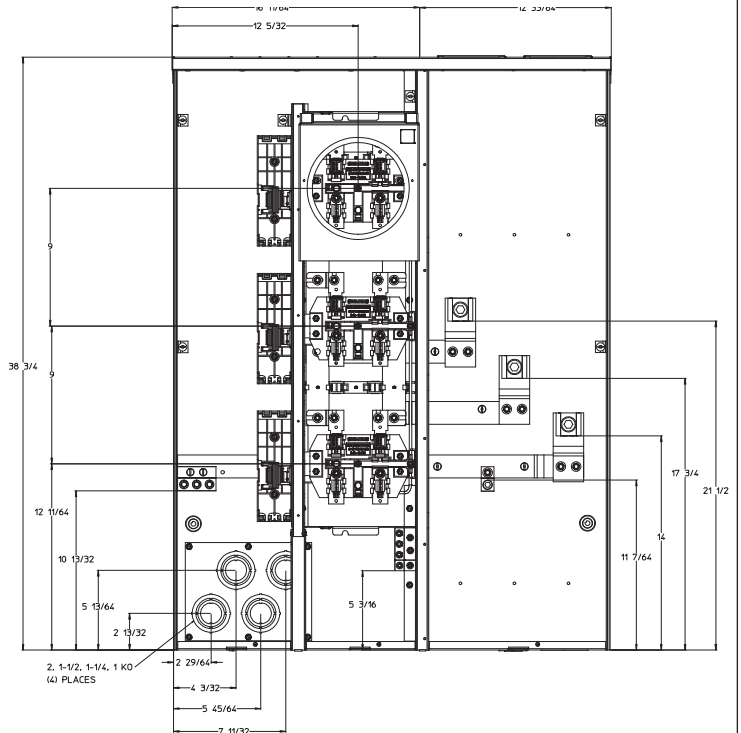

WP4312 WEP4312

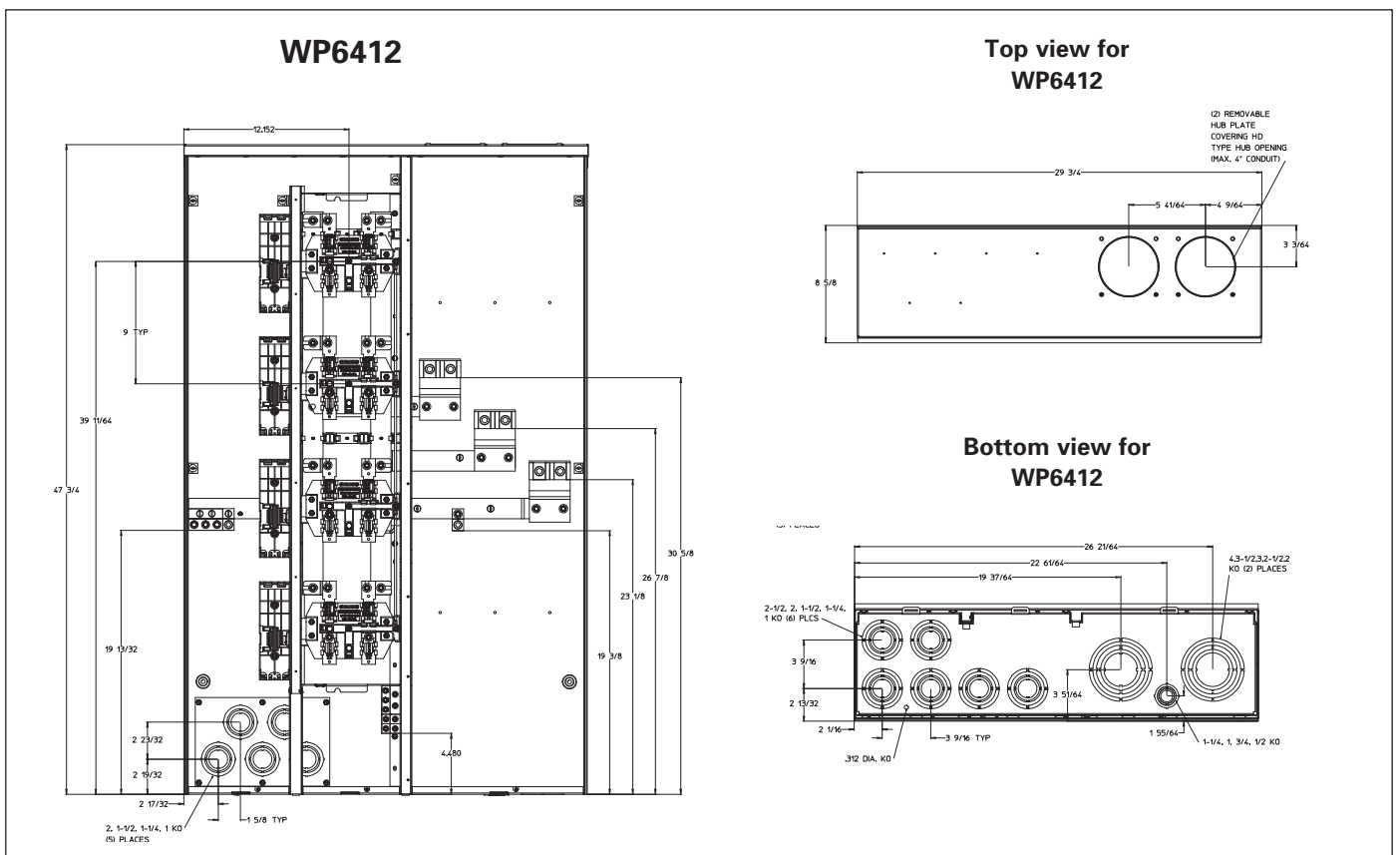
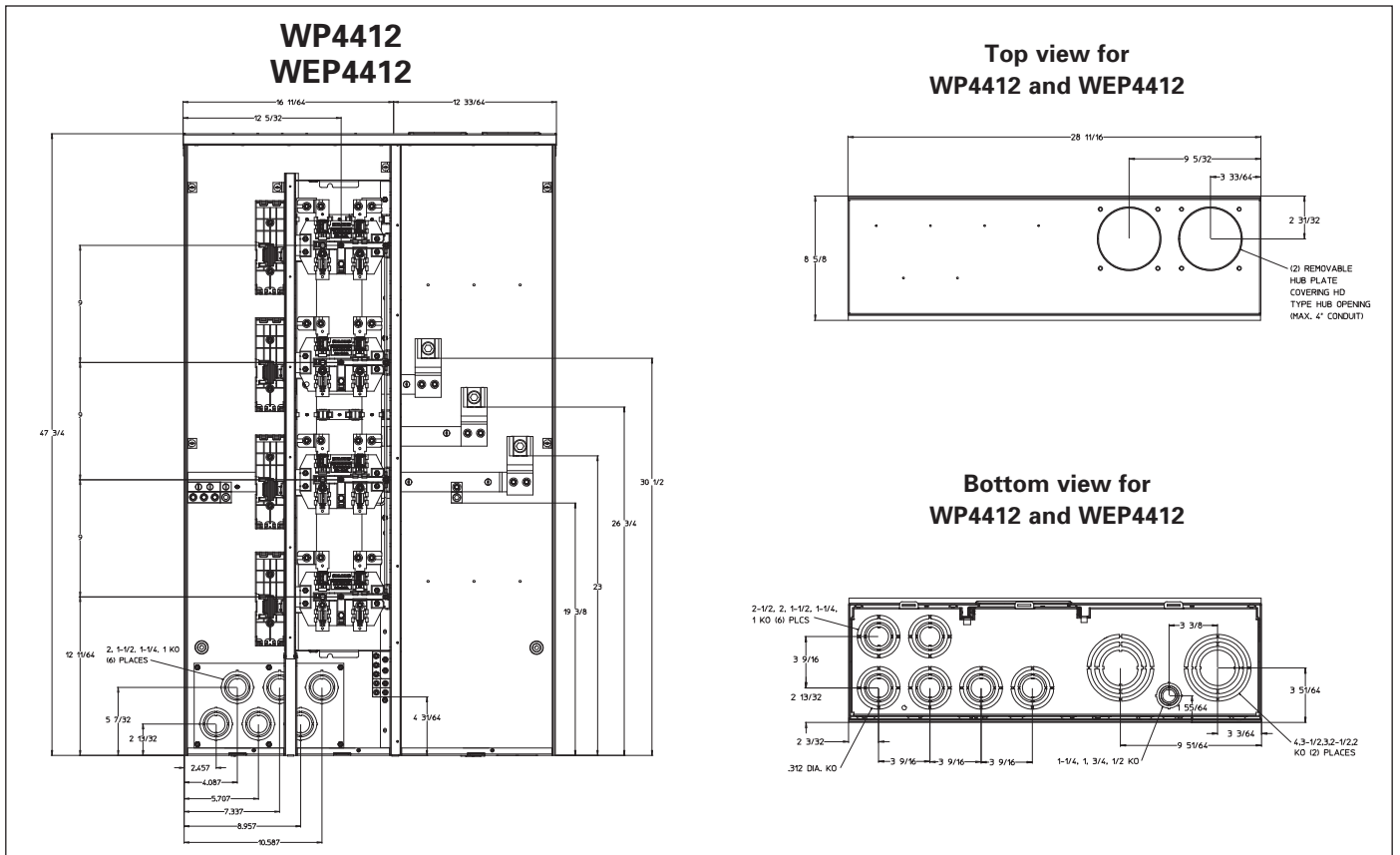

Uni-PAK

Uni-PAK Metering: Dimensional and Knockout Diagrams

WEP6412

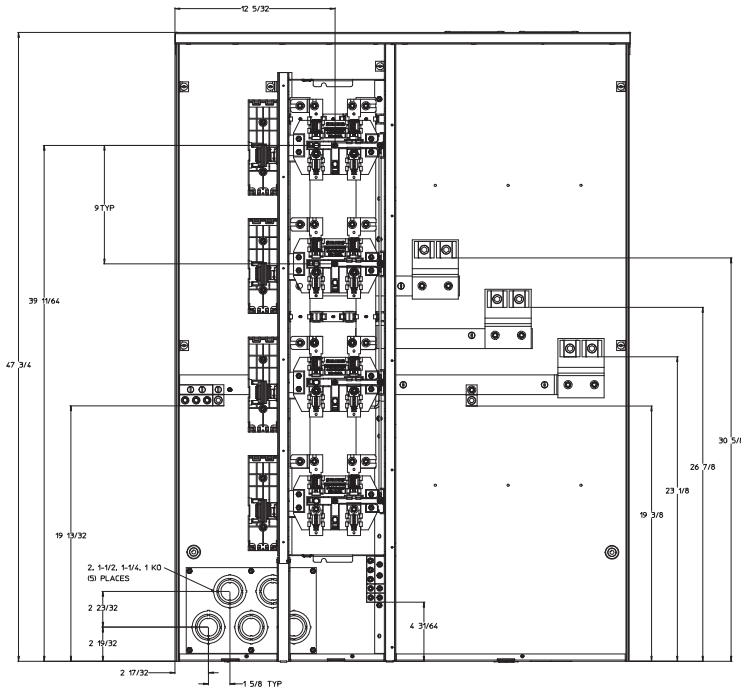

Top view for WEP6412

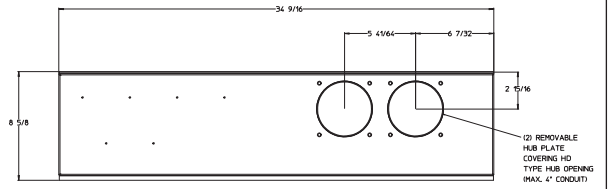

Bottom view for WEP6412

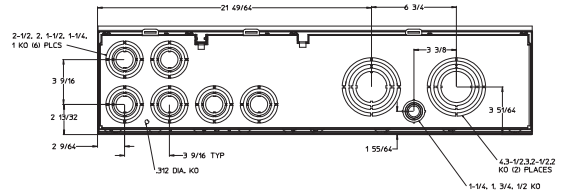

WP8612 WEP8612

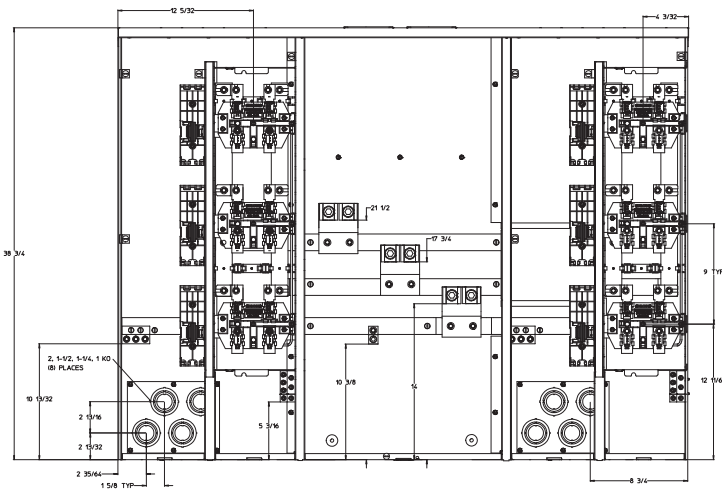

Top view for WP8612 and WEP8612

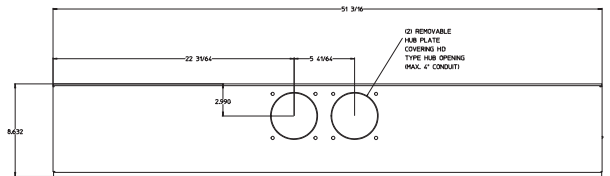

Bottom view for WP8612 and WEP8612

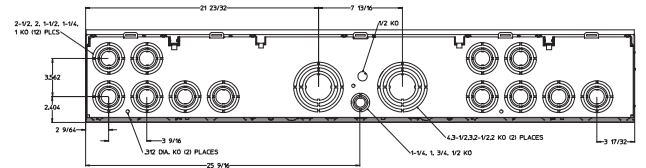

Uni-PAK

Uni-PAK Metering: Dimensional and Knockout Diagrams

WP6512

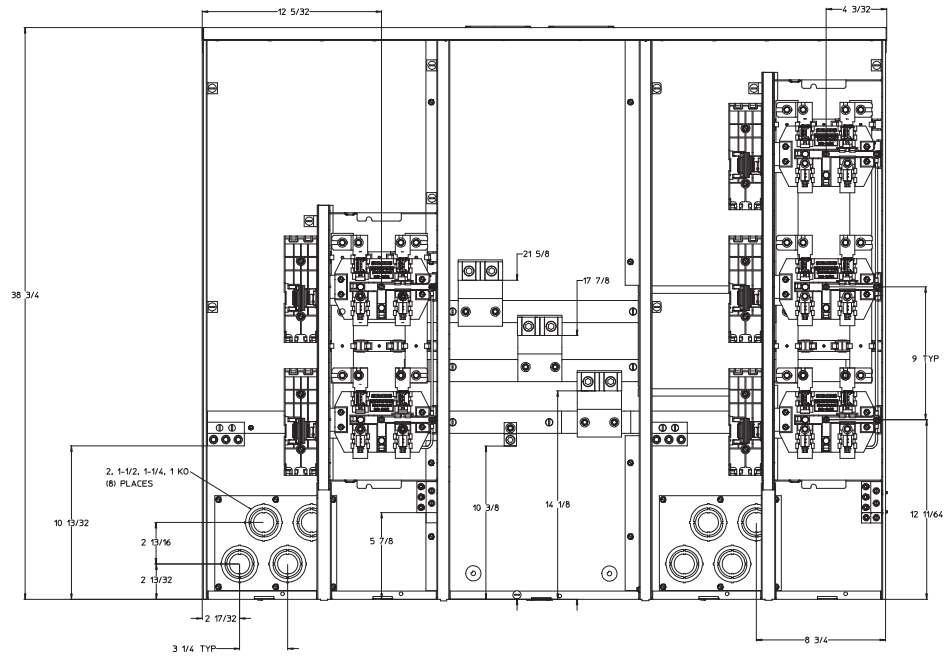

Top view for WP6512 and WP6612

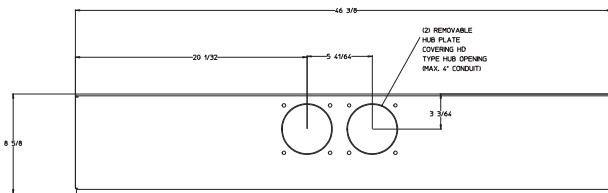

Bottom view for WP6512 and WP6612

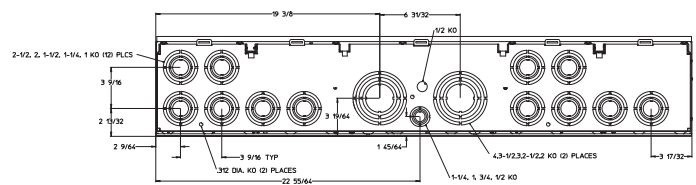

WP6612

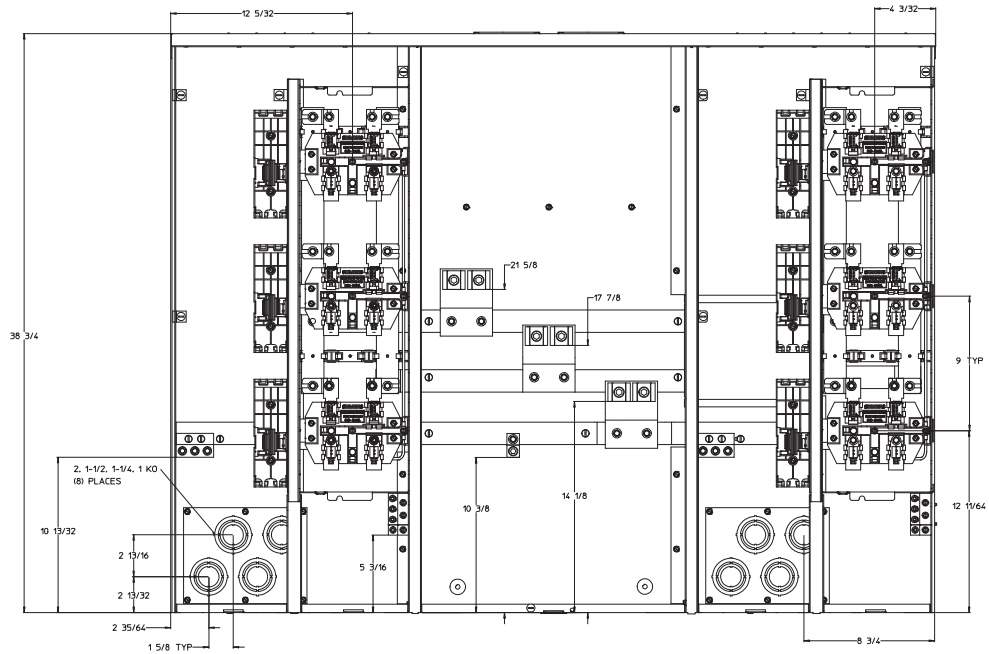

Uni-PAK

Uni-PAK Metering: Dimensional and Knockout Diagrams

WEP6512

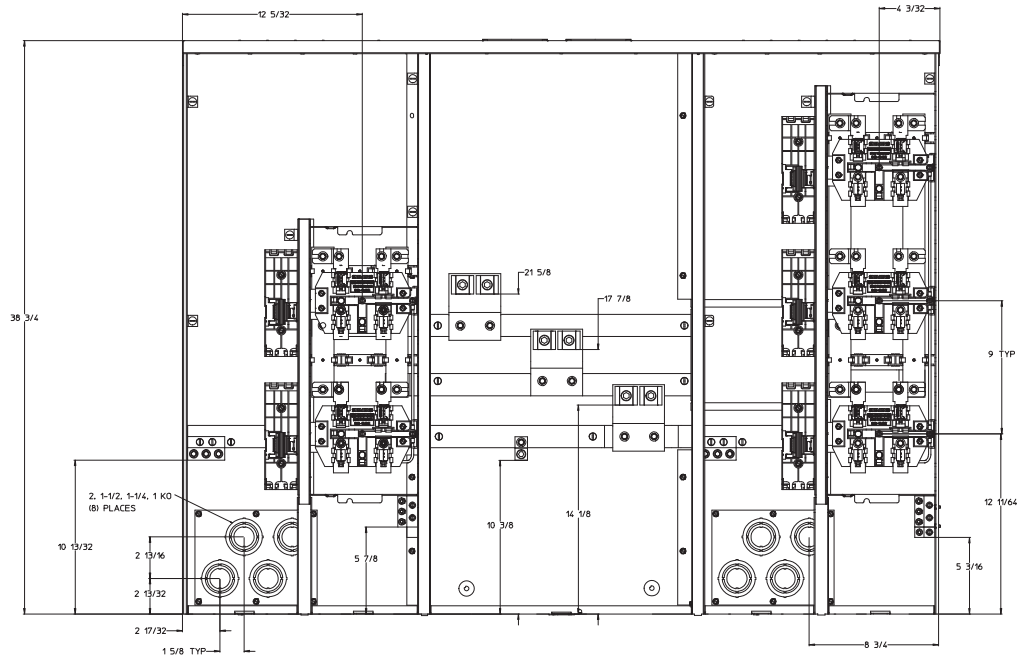

Top view for WEP6512 and WEP6612

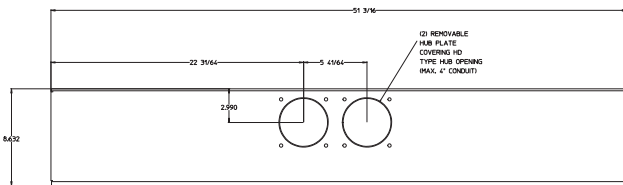

Bottom view for WEP6512 and WEP6612

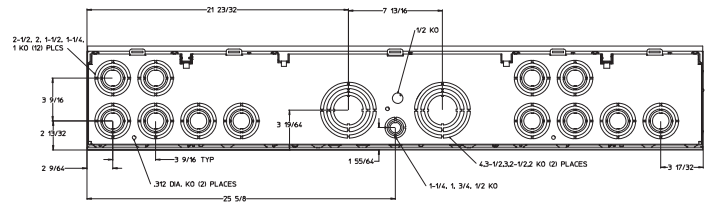

WEP6612

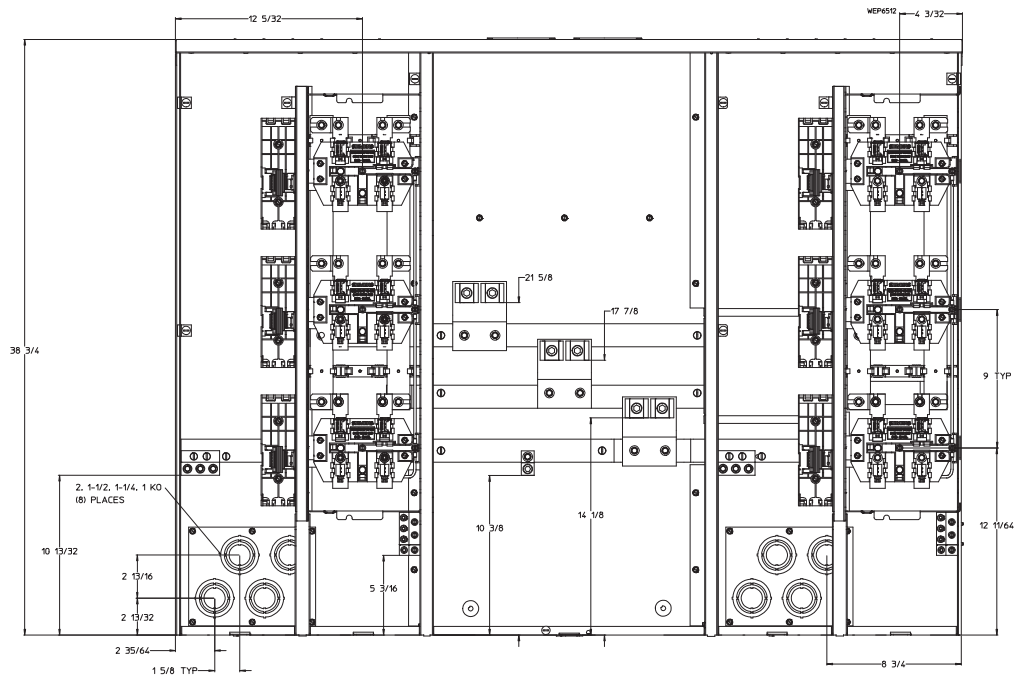

Uni-PAK

Uni-PAK Metering: Dimensional and Knockout Diagrams

WPL4312

Top view for WPL4312 and WPL4412

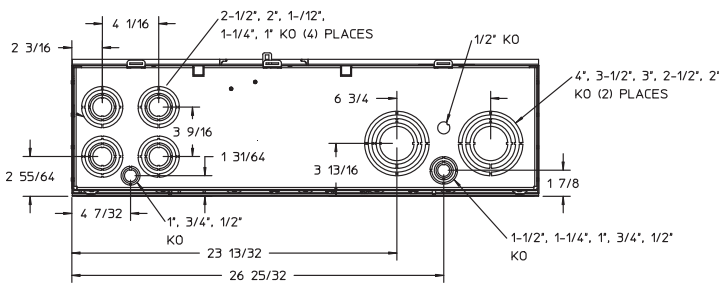
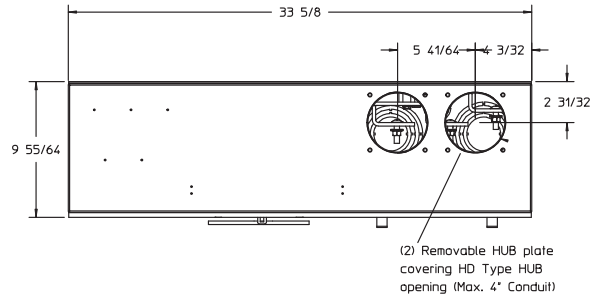
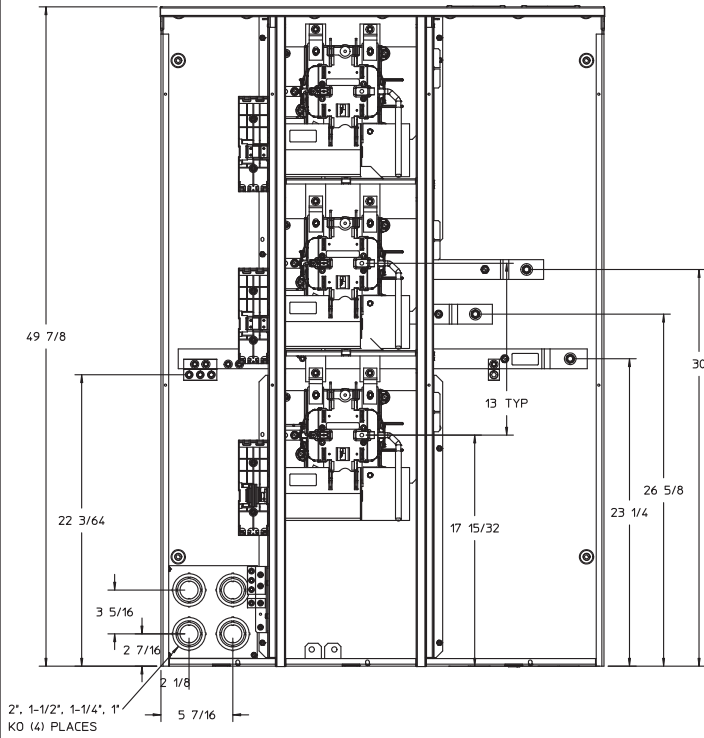

Bottom view for WPL4312 and WPL4412

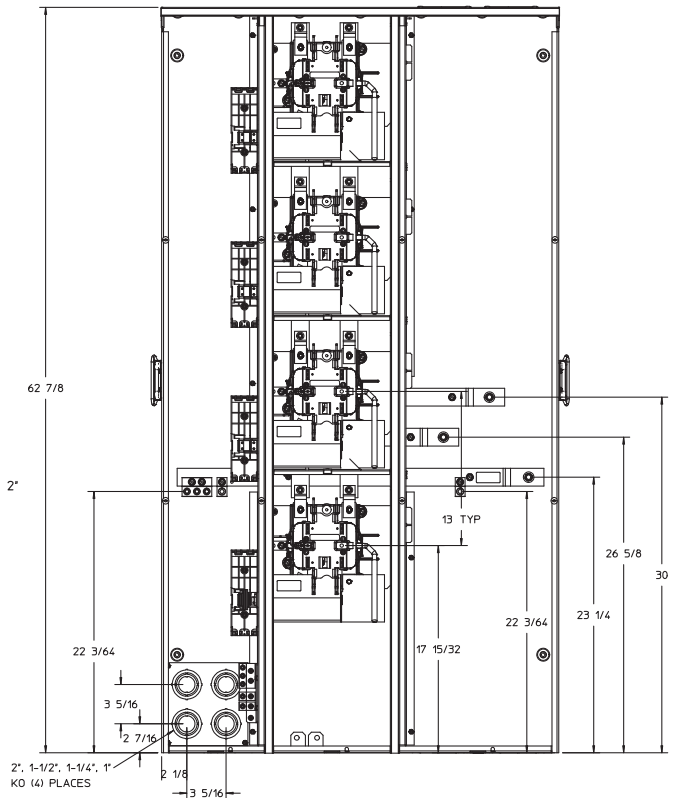

WPL4412

WPL6512

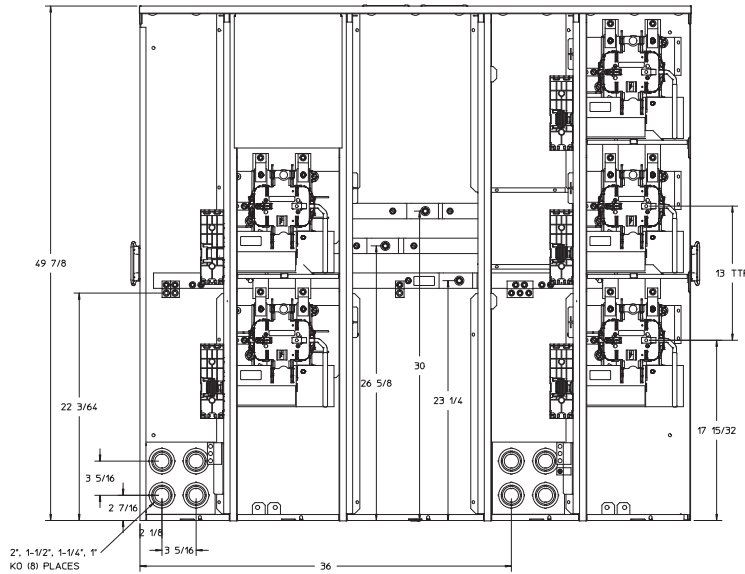

Top view for WPL6512 and WPL6612

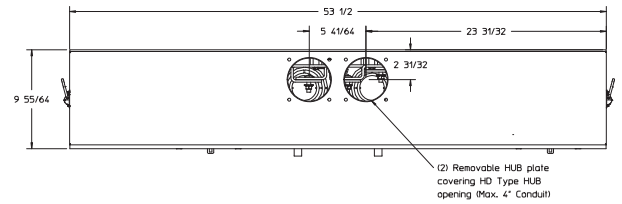

Bottom view for WPL6512 and WPL6612

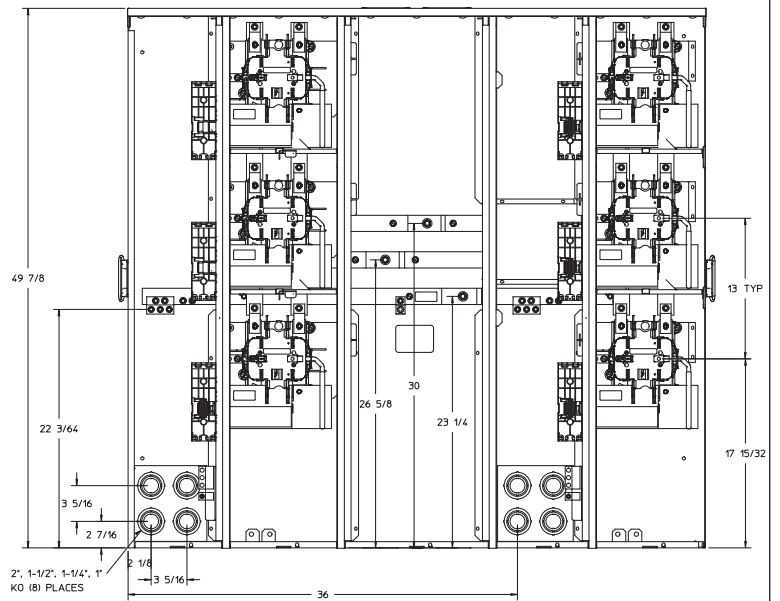
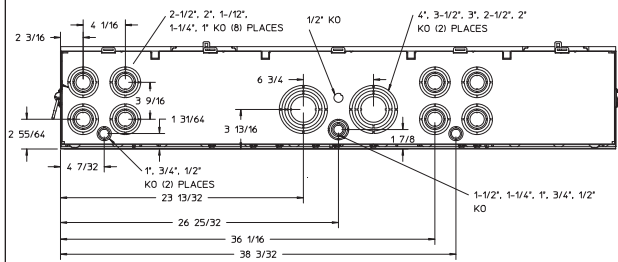

WPL6612

WPL8612 WPL10612

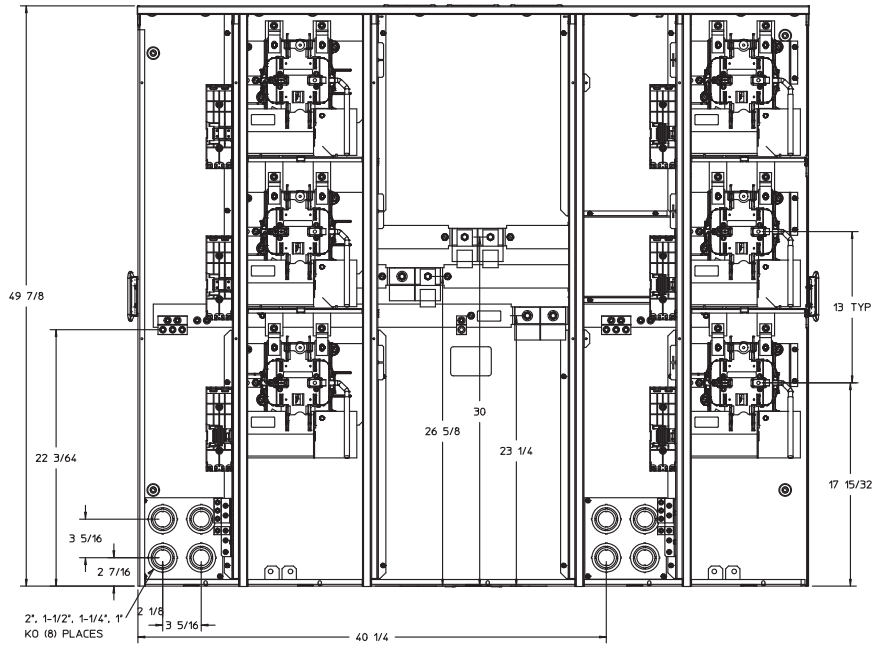

Top view for
WPL8612 and WPL10612

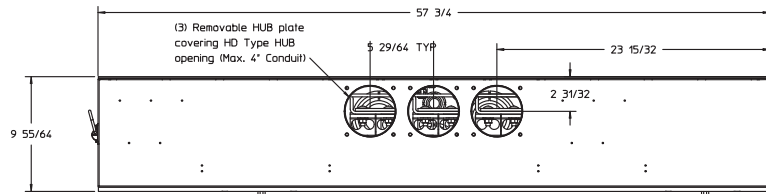

Bottom view for
WPL8612 and WPL10612

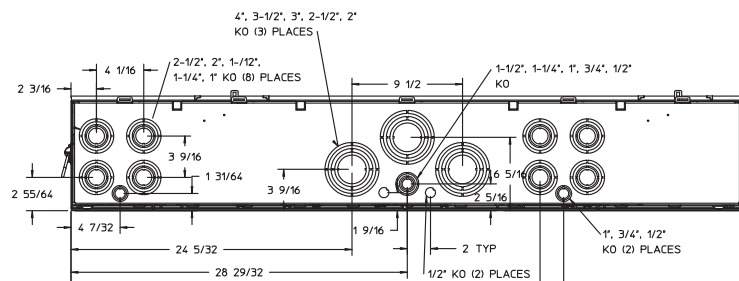

Power Mod and Uni-PAK

Multifamily Metering Accessories and Replacement Parts

Lugs, breakers and other accessories

Siemens offers a wide range of accessories to help your product fit the application. Eliminate the need for special orders with replacement part kits available for your convenience. All kits come with appropriate hardware and instruction sheets for installation.

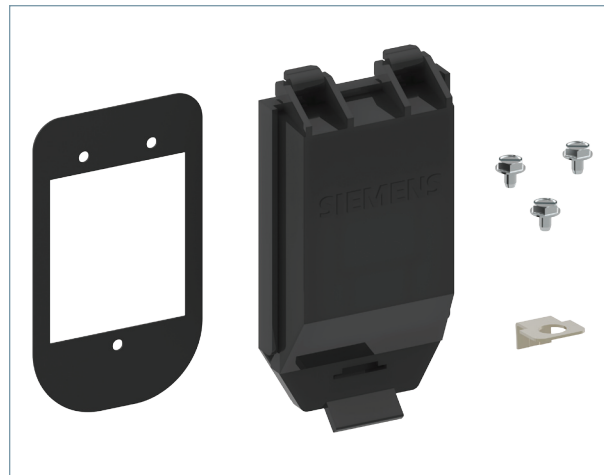
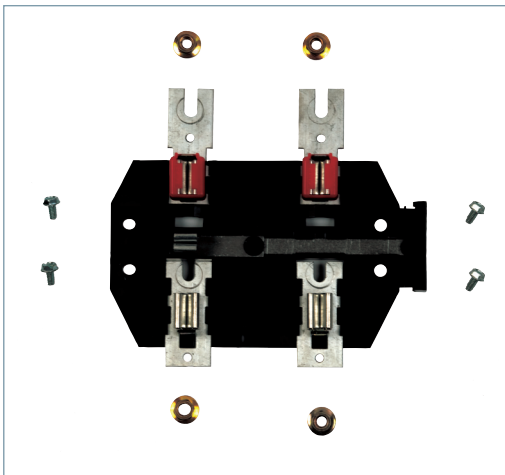

Power Mod

Lug Kits: Lug selector

Lugs are factory installed on WB main breaker modules 200A-1200A. Alternate lug kit options (including 750kcmil) are available.

A field installable compression lug landing pad is available as an accessory for standard breaker module 250A-1200A. Compression lug kits must be ordered in addition to the lug landing pad accessory. The lug landing pad accessory is not

compatible with WB skinny mains (200-1200A WB's with B, BU, T or TU suffixes).

Lug kits must be ordered separately for standard breaker modules 1400A-2000A.

All EUSERC breaker mains, standard switches, EUSERC switches, standard tap boxes, and EUSERC tap boxes require lugs to be ordered separately and field installed.

3
METER
CENTERS

Standard Breaker Main Types WB and WBM (Do not use this table for Skinny Mains)				
Amperage	No. Wires per Phase	Max Wire Size	1 Phase lug kit	3 Phase lug kit
200-400	1	750 kcmil	LK11750 ^①	LK31750 ^①
	2	500 kcmil	LK12500 ^{①②}	LK32500 ^{①②}
450-600	2	500 kcmil	LK12500 ^{①②}	LK32500 ^{①②}
700-800	3	500 kcmil	LK13500 ^{①②}	LK33500 ^{①②}
	3	750 kcmil	LK13750 ^①	LK33750 ^①
900-1200	3	750 kcmil	LK13750 ^①	LK33750 ^①
	4	500 kcmil	LK14500 ^{①②}	LK34500 ^{①②}
1400-1600	5	600 kcmil	LK15600N2	LK35600N2
	5	750 kcmil	LK15750N2	LK35750N2
	6	750 kcmil	LK16750N2	LK36750N2
1800-2000	6	750 kcmil	LK16750N2	LK36750N2

Standard Breaker Main with Lug Landing Pad Installed ^③ Types WB and WBM				
Amperage	No. Wires per Phase	Max Wire Size	1 Phase lug kit	3 Phase lug kit
200-400	1	600 kcmil	LK11600N2	LK31600N2
	2	350 kcmil	LK12350N2	LK32350N2
450-600	2	350 kcmil	LK12350N2	LK32350N2
700-800	2	600 kcmil	LK12600N2	LK32600N2
	2	750 kcmil	LK12750N2	LK32750N2
	3	500 kcmil	LK13500N2	LK33500N2
	3	750 kcmil	LK13750N2	LK33750N2
900-1200	4	500 kcmil	LK14500N2	LK34500N2
	3	750 kcmil	LK13750N2	LK33750N2
	4	500 kcmil	LK14500N2	LK34500N2

Skinny Breaker Main Types WB and WBM (Skinny Mains are 200-1200A WB/WBM units, with B, BU, T, or TU suffixes)				
Amperage	No. Wires per Phase	Max Wire Size	1 Phase lug kit	3 Phase lug kit
200-400	1	750 kcmil	LK11750 ^①	LK31750 ^①
	2	500 kcmil	LK12500 ^{①②}	LK32500 ^{①②}
450-600	2	500 kcmil	LK12500 ^{①②}	LK32500 ^{①②}
700-800	3	500 kcmil	LK13500 ^{①②}	LK33500 ^{①②}
	3	750 kcmil	LK13750 ^①	LK33750 ^①
	4	500 kcmil	LK14500 ^①	LK34500 ^①
900-1200	3	750 kcmil	LK13750 ^①	LK33750 ^①
	4	500 kcmil	LK14500 ^{①②}	LK34500 ^{①②}

Definition of suffixes:	
(no N2) =	square sentron breaker type lugs
N2(E) =	Nema 2-stud lug mounting pattern
N2C =	Same as N2 except designed for use with copper wire. Includes upward bus extension kit.
N2A =	Same as N2 except designed for use with aluminum wire. Includes upward bus extension kit.
N2CD=	Same as N2C except includes downward bus extension kit instead of upward extension.
N2AD=	Same as N2A except includes downward bus extension kit instead of upward extension.

EUSERC Breaker Main Types WEB and WEBM				
Amperage	No. Wires per Phase	Max Wire Size	1 Phase lug kit	3 Phase lug kit
200-400	1	750 kcmil	LK11750N2	LK31750N2
	2	500 kcmil	LK12500N2	LK32500N2
500-600	2	500 kcmil	LK12500N2E	LK32500N2E
	2	750 kcmil	LK12750N2	LK32750N2
	3	750 kcmil	LK13750N2	LK33750N2
	4	500 kcmil	LK14500N2	LK34500N2
700-800	2	600 kcmil	LK12600N2	LK32600N2
	2	750 kcmil	LK12750N2	LK32750N2
	3	500 kcmil	LK13500N2	LK33500N2
	3	750 kcmil	LK13750N2	LK33750N2
	3	750 kcmil	LK13750N2E	LK33750N2E
	4	500 kcmil	LK14500N2	LK34500N2
	4	500 kcmil	LK14500N2E	LK34500N2E
	5	600 kcmil	LK15600N2	LK35600N2
900-1200	3	750 kcmil	LK13750N2E	LK33750N2E
	4	500 kcmil	LK14500N2E	LK34500N2E
	5	600 kcmil	LK15600N2	LK35600N2

Feed-Thru Tap Box with Breaker Type WBT			
Amperage	No. Wires per Phase	Max Wire Size	3 Phase lug kit
1200	3	750 kcmil	LK33750N2
	4	500 kcmil	LK34500N2
2400	6	750 kcmil	LK36750N2
	8	500 kcmil	LK38500N2C
	8	750 kcmil	LK38750N2A

Feed-Thru Breaker Main Types BFT and BFTM				
Amperage	No. Wires per Phase	Max Wire Size	1 Phase lug kit	3 Phase lug kit
1200	3	750 kcmil	LK13750N2	LK33750N2
	4	500 kcmil	LK14500N2	LK34500N2
	5	600 kcmil	LK15600N2	LK35600N2
	5	750 kcmil	LK15750N2	LK35750N2
	6	750 kcmil	LK16750N2	LK36750N2
	8	500 kcmil	LK18500N2CD	LK38500N2CD
	8	750 kcmil	LK18750N2AD	LK38750N2AD
	8	750 kcmil	LK18750N2AD	LK38750N2AD
1400-1600	5	600 kcmil	LK15600N2	LK35600N2
	5	750 kcmil	LK15750N2	LK35750N2
	6	750 kcmil	LK16750N2	LK36750N2
	8	500 kcmil	LK18500N2CD	LK38500N2CD
1800-2000	8	750 kcmil	LK18750N2AD	LK38750N2AD
	6	750 kcmil	LK16750N2	LK36750N2
	8	500 kcmil	LK18500N2CD	LK38500N2CD
	8	750 kcmil	LK18750N2AD	LK38750N2AD

① Lug kits - Sentron mechanical breaker lugs
 ② Factory installed lugs
 ③ Lug landing pad must be ordered in addition to lug kit. Refer to 3-129 for lug landing pad options.
 ④ WT tap boxes require 2 lug kits when used on feed thru applications.

Power Mod

Lug Kits: Lug selector

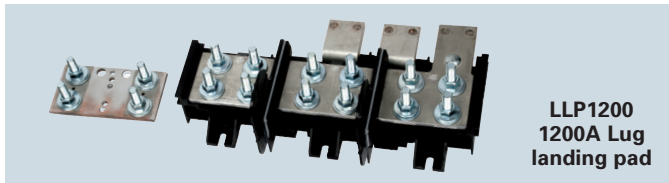

Note that while some connector kits may physically fit, the maximum wire range of the connector may not meet UL required bending space. If a lug kit other than what is on the wiring diagram is used, it is up to the installer to ensure the installation is acceptable.

Standard Switch Main Type WS				
Amperage	No. Wires per Phase	Max Wire Size	1 Phase lug kit	3 Phase lug kit
400	1	600 kcmil	LK11600N2	LK31600N2
	2	500 kcmil	LK12500N2	LK32500N2
	2	500 kcmil	LK12500N2E	LK32500N2E
600	2	750 kcmil	LK12750N2	LK32750N2
	2	500 kcmil	LK12500N2	LK32500N2
800	2	500 kcmil	LK12500N2E	LK32500N2E
	2	600 kcmil	LK12600N2	LK32600N2
	3	750 kcmil	LK12750N2	LK32750N2
1200	3	500 kcmil	LK13500N2	LK33500N2
	4	500 kcmil	LK14500 ^{①②}	LK34500 ^{①②}

EUSERC Switch Main Type WES				
Amperage	No. Wires per Phase	Max Wire Size	1 Phase lug kit	3 Phase lug kit
400	1	750 kcmil	LK11750N2	LK31750N2
	2	500 kcmil	LK12500N2	LK32500N2
600	2	500 kcmil	LK12500N2	LK32500N2
	2	750 kcmil	LK12750N2	LK32750N2
	3	750 kcmil	LK13750N2	LK33750N2
800	4	500 kcmil	LK14500N2	LK34500N2
	2	600 kcmil	LK12600N2	LK32600N2
	2	750 kcmil	LK12750N2	LK32750N2
	3	500 kcmil	LK13500N2	LK33500N2
1200	3	750 kcmil	LK13750N2	LK33750N2
	4	500 kcmil	LK14500N2	LK34500N2
	5	600 kcmil	LK15600N2	LK35600N2

Standard Tap Box Type WTB				
Amperage	No. Wires per Phase	Max Wire Size	1 Phase lug kit	3 Phase lug kit
400	1	600 kcmil	LK11600N2	LK31600N2
	1	750 kcmil	LK11750N2	LK31750N2
	2	500 kcmil	LK12500N2	LK32500N2
800	2	600 kcmil	LK12600N2	LK32600N2
	2	750 kcmil	LK12750N2	LK32750N2
	3	500 kcmil	LK13500N2	LK33500N2
1200	3	750 kcmil	LK13750N2	LK33750N2
	4	500 kcmil	LK14500N2	LK34500N2
1600	5	600 kcmil	LK15600N2	LK35600N2
	5	750 kcmil	LK15750N2	LK35750N2
	6	750 kcmil	LK16750N2	LK36750N2
2000	6	750 kcmil	LK16750N2	LK36750N2
	8	500 kcmil	LK18500N2C	LK38500N2C
	8	750 kcmil	LK18750N2A	LK38750N2A
2400	6	750 kcmil	LK16750N2	LK36750N2
	8	500 kcmil	LK18500N2C	LK38500N2C
	8	750 kcmil	LK18750N2A	LK38750N2A

EUSERC Tap Box Type WET				
Amperage	No. Wires per Phase	Max Wire Size	1 Phase lug kit	3 Phase lug kit
400	1	750 kcmil	LK11750N2	LK31750N2
	2	500 kcmil	LK12500N2	LK32500N2
800	2	600 kcmil	LK12600N2	LK32600N2
	2	750 kcmil	LK12750N2	LK32750N2
	3	500 kcmil	LK13500N2	LK33500N2
	3	750 kcmil	LK13750N2	LK33750N2
1200	4	500 kcmil	LK14500N2	LK34500N2
	3	750 kcmil	LK13750N2E	LK33750N2E
	4	500 kcmil	LK14500N2E	LK34500N2E
1200	5	600 kcmil	LK15600N2	LK35600N2

Feed-Thru Tap Box Type WT_PU ^④					
Amperage	No. Wires per Phase	Max Wire Size	1 Phase lug kit	3 Phase lug kit	
400	1	750 kcmil	LK11750N2	LK31750N2	
	2	500 kcmil	LK12500N2	LK32500N2	
800	2	600 kcmil	LK12600N2	LK32600N2	
	2	750 kcmil	LK12750N2	LK32750N2	
	3	500 kcmil	LK13500N2	LK33500N2	
	4	500 kcmil	LK14500N2	LK34500N2	
1200	3	750 kcmil	LK13750N2	LK33750N2	
	4	500 kcmil	LK14500N2E	LK34500N2E	
	5	600 kcmil	LK15600N2	LK35600N2	
1600	5	600 kcmil	LK15600N2	LK35600N2	
	5	750 kcmil	LK15750N2	LK35750N2	
	6	750 kcmil	LK16750N2	LK36750N2	
	8	500 kcmil	LK18500N2C	LK38500N2C	
	8	750 kcmil	LK18750N2A	LK38750N2A	
	2000	6	750 kcmil	LK16750N2	LK36750N2
	8	500 kcmil	LK18500N2C	LK38500N2C	
	8	750 kcmil	LK18750N2A	LK38750N2A	
2400	6	750 kcmil	LK16750N2	LK36750N2	
	8	500 kcmil	LK18500N2C	LK38500N2C	
	8	750 kcmil	LK18750N2A	LK38750N2A	

ConEd Tap Box Type WTBN			
Amperage	No. Wires per Phase	Max Wire Size	1 Phase lug kit
400	1	600 kcmil	LK31600N2
	1	750 kcmil	LK31750N2
	2	350 kcmil	LK32350N2
600	2	500 kcmil	LK32500N2
	2	350 kcmil	LK32350N2
800	2	500 kcmil	LK32500N2
	2	600 kcmil	LK32600N2
800	2	750 kcmil	LK32750N2
	3	500 kcmil	LK33500N2
	4	500 kcmil	LK34500N2
	1200	3	750 kcmil
1200	4	500 kcmil	LK34500N2

① Lug kits - Sentron mechanical breaker lugs
 ② Factory installed lugs
 ③ Lug landing pad must be ordered in addition to lug kit. Refer to 3-129 for lug landing pad options.
 ④ WT tap boxes require 2 lug kits when used on feed thru applications.

Power Mod

Modular Metering Lug Kits

Power Mod: Modular Metering Lug Kits

Lug Kits Quick Reference

- UL 486 A/B
- Tin-plated aluminium
- NEMA 2-stud lug mounting pattern

Lug Kit Contents

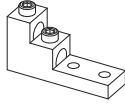
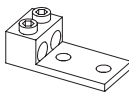
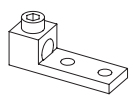
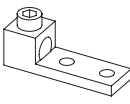
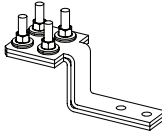
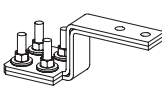
Wire Range: 1/0-750 kcmil	Wire Range: #6-350 kcmil	Wire Range: #2-600 kcmil	Wire Range: 300-800 kcmil	Upward Bus Extension	Downward Bus Extension
					
Wire Binding Screw Torque: 500 lb.-in.	Wire Binding Screw Torque: 275 lb.-in.	Wire Binding Screw Torque: 500 lb.-in.	Wire Binding Screw Torque: 500 lb.-in.	Wire Binding Screw Torque: 500 lb.-in.	Wire Binding Screw Torque: 500 lb.-in.

Lug Kit Catalog Number	Wire Range	Lug Quantity	Lug Quantity	Lug Quantity	Lug Quantity	Unit Quantity	Unit Quantity
LK12350N2	#6-350 kcmil		3				
LK32350N2	#6-350 kcmil		4				
LK12500N2	1/0-500 kcmil	3					
LK32500N2	1/0-500 kcmil	4					
LK12500N2E	#2-500 kcmil			6			
LK32500N2E	#2-500 kcmil			8			
LK13500N2	1/0-500 kcmil	3		3			
LK33500N2	1/0-500 kcmil	4		4			
LK14500N2	1/0-500 kcmil	6					
LK34500N2	1/0-500 kcmil	8					
LK14500N2E	1/0-500 kcmil	3		6			
LK34500N2E	1/0-500 kcmil	4		8			
LK15600N2	1/0-600 kcmil	6		3			
LK35600N2	1/0-600 kcmil	8		4			
LK11600N2	#2-600 kcmil			3			
LK31600N2	#2-600 kcmil			4			
LK12600N2	#2-600 kcmil			6			
LK32600N2	#2-600 kcmil			8			
LK11750N2	300-750 kcmil				3		
LK31750N2	300-750 kcmil				4		
LK12750N2	300-750 kcmil				6		
LK32750N2	300-750 kcmil				8		
LK13750N2	300-750 kcmil	3			3		
LK33750N2	300-750 kcmil	4			4		
LK13750N2E	300-750 kcmil				9		
LK33750N2E	300-750 kcmil				12		
LK15750N2	300-750 kcmil	6			3		
LK35750N2	300-750 kcmil	8			4		
LK16750N2	1/0-750 kcmil	9					
LK36750N2	1/0-750 kcmil	12					
LK18500N2C	1/0-500 kcmil CU	12				3	
LK38500N2C	1/0-500 kcmil CU	16				4	
LK18570N2A	1/0-750 kcmil AL	12				3	
LK38570N2A	1/0-750 kcmil AL	16				4	
LK18500N2CD	1/0-500 kcmil CU	12					3
LK38500N2CD	1/0-500 kcmil CU	16					4
LK18570N2AD	1/0-750 kcmil AL	12					3
LK38570N2AD	1/0-750 kcmil AL	16					4









Power Mod and Uni-PAK

Multifamily Metering Accessories and Replacement Parts

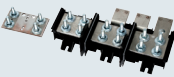
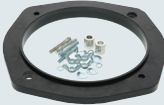
Conduit Hubs

Catalog Number	Description
Type RX	
EC38594	3/4" Conduit Hub
EC38596	1" Conduit Hub
EC38597	1 1/4" Conduit Hub
EC38598	1 1/2" Conduit Hub
EC9747-1113	Adapter plate for HD/RX

Type HD	
EC56854 ^②	2" Conduit Hub
EC56855 ^②	2 1/2" Conduit Hub
EC56856	3" Conduit Hub
EC56857	3 1/2" Conduit Hub
EC56858	4" Conduit Hub
EC56933S	Closure Plate

Accessory	Catalog number	Description
	QC1	QuickConnect 1-phase, 3-wire, 1200 Amp maximum.
	QC4	QuickConnect 3-phase, 4-wire, 1200 Amp maximum.
	LLP600 ^⑤	Lug Landing Pad for 200-600 Amp Standard Breaker modules (WB) only. Allows for use of compression lugs or NEMA 2-stud type lugs. Not compatible with Skinny mains.
	LLP1200 ^⑤	Lug Landing Pad for 800-1200 Amp Standard Breaker modules (WB) only. Allows for use of compression lugs or NEMA 2-stud type lugs. Not compatible with Skinny mains.
	WMMBK ^①	Pass-thru bushing - for use with pull box WMMB modules.
	WMEP	Plastic end enclosure plate to cover exposed horizontal bussing at the ends of the meter center lineup. Comes factory included with all mains and tapboxes. This kit comes with (1) plate, (1) gasket and (4) screws.
	SRSS	Sealing ring - snap-on, stainless steel.
	SRSW	Sealing ring - screw type, stainless steel.
	SRSTD	Sealing ring - snap on, aluminum (comes standard).
	ECJS ^③	Meter bypass jumper 4 AND 5 JAW. For temporary use ONLY. Only works with ECPP cover. 200A max. Comes with 2 jumpers. Not for use with WML sockets over 200A. Not compatible with utility anti-inversion clips.
	ECPP	Plastic Ring Style cover plate. May be used with ringless style cover in conjunction with ECJS.







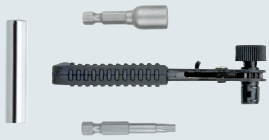

① As of 4/10/2019 this bushing is no longer supplied with WMMB devices. If needed it must be ordered separately.
 ② Item is a kit consisting of adapter plate and RX Type Hub

③ Required per 1-phase meter socket. Residential type ring and ringless - 200 Amp max. Meter cannot be installed while in use. Made for use with ECPP cover plate.

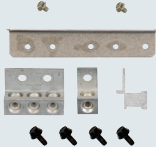
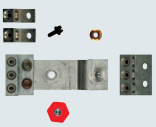
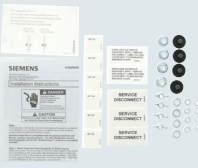
④ No kits are available for WEP2211.
 ⑤ Cannot be used for top-feed applications.

Power Mod and Uni-PAK

Multifamily Metering Accessories and Replacement Parts

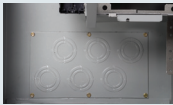
Accessory	Catalog number	Description
	ECCP3	Plastic Ringless Style cover plate.
	ECMMRS	Power Mod mini ratchet set Includes: <ul style="list-style-type: none"> ■ 2" T-25 Torx Bit - Eases removal and re-installing of cover screws ■ 5/16" Magnetic Nut Setter - Eases the installation of tap boxes when QuickBolt assembly is required to be removed from one side. In addition, could be used to quickly install or reposition the 5th jaw. ■ 3/8" x 1/4" drive deep well socket - Eases connection of adjacent module using hardware provided.
	ECMFTAB	Mounting tabs or "ears" for top of Power Mod devices. Comes with 2 tabs.
	ECMFGN125	Kit for replacement or additional ground and neutral lugs for 100-125 Amp (W)MM, (W)MN, (W)ML and (W)MLZ(F) stacks. Can also be used as the replacement or additional ground lug kit for 225 Amp (W)MM, (W)MN, (W)MT and (W)ML stacks.
	ECMFN225	Neutral lug kit for 225 Amp stacks (type (W)MM, (W)MN, (W)MT and (W)ML stacks only).
	ECMFPK	Power Mod loose parts replacement kit. Includes: instruction sheet, (6) apartment number labels, (6) service disconnect labels, (4) 1/4-20 hex nuts, (4) #10-32 hex nuts, (4) 1/4-20 x 1/2 screws, (4) wingnuts, (4) #10 flat washers, (4) #10 lock washers.
	ECMFCS	Cover screw replacement (quantity 10) for Power Mod and Uni-PAK devices.
	ECMMBC	Power Mod breaker cover replacement Type 3. Used only on 1200A WES mains, all WMK stacks, 100A 3-ph in/3-ph out (W)ML stacks and 400A (W)ML non-fused stacks.
	ECMMBCM	Power Mod replacement plastic breaker cover for type all current 200-1000A WB, WXB, WEB and WBT main breaker units. This is also the replacement cover for all 1200A-2000A main breaker devices manufactured prior to 4/16/2018. [Please note that WB skinny mains and WBT mains manufactured between the dates of 4/16/2018 and 6/14/2019 in the 900-1000Amp range temporarily used the ECMMBCL cover. After 6/14/2019 these 900-1000A WB skinny and WBT mains transitioned to use ECMMBCM.] This cover is also used for 225A 3-phase (W)ML stacks.
	ECBC	Breaker cover replacement for type (W)MM, (W)ML, WMT single phase meter stacks and series WP, WEP, WPL, and WPC Uni-PAK.
	ECMMBCL	Power Mod replacement plastic breaker cover for all 1200-2000A main breaker modules manufactured on or after 4/16/2018 (WB, WXB, WEB, WBT and BFT). [Please note that WB skinny mains and WBT mains manufactured between the dates of 4/16/2018 and 6/14/2019 in the 900-1000Amp range used this ECMMBCL cover as well.]
	ECMMKOP	Power Mod knock-out plate with knock-outs for type (W)MM Residential Stacks (not suitable for Uni-PAK). Attaches to back wall of unit.











Power Mod and Uni-PAK

Multifamily Metering Accessories and Replacement Parts

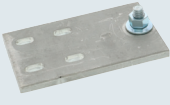
Accessory	Catalog number	Description
	ECMMNKOP	Power Mod knock-out plate without knock-outs for Type (W)MM Residential Stacks (not suitable for Uni-Pak). This is a blank plate, ideal for contractors who want to cut their own holes in the back plate.
	ECMLNKOP	Blank removable back plate for 100A (3-phase) and 225A (W)ML stacks as well as all 1-phase-out (W)MT stacks. (not suitable for Uni-PAK).
	ECMFWLCLIP	Replacement rail/clip located on back of unit with wheels (Power Mod only).
	MMCLIP	Replacement rail/clip that comes on back of unit, no wheels (for Power Mod modules manufactured prior to 2009).
	MMRAIL	12" Standard wall mounting rail (Power Mod or Uni-PAK).
	MMZR24	24" long mounting "Z" rail for wall mounting (Power Mod or Uni-PAK).
	MMZR36	36" long mounting "Z" rail for wall mounting (Power Mod or Uni-PAK).
	MMZR48	48" long mounting "Z" rail for wall mounting (Power Mod or Uni-PAK).
	MMZR60	60" long mounting "Z" rail for wall mounting (Power Mod or Uni-PAK).
	ECMFH	Horn bypass kit for field replacement or addition on ringless type (W)MM meter stacks and ringless series WP and WPC Uni-PAK.
	ECMF5	5th jaw replacement for Power Mod type (W)MM meter stacks and series WP, WEP, and WPC Uni-PAK.
	ECMT5	5th jaw Power Mod stack WMT. 1-ph in/1-ph out only.
	ECMF5i	Isolated 5th jaw. Allows for 5th jaw to be disconnected from the neutral while in place. For use on (W)MM and (W)MN stacks only.
	ECMFS	Meter socket replacement for Power Mod type (W)MM meter stacks and series WP, WEP, and WPC Uni-PAK.
	ECMFBM1	Breaker mounting replacement for 125 Amp Power Mod type (W)MM, (W)ML, WMT single phase meter stacks and series WP, WEP, WPL and WPC Uni-PAK.
	ECMFBM2	Breaker mounting replacement for 225 Amp Power Mod type (W)MM, (W)ML, WMT single phase meter stacks and series WP, WEP, WPL and WPC Uni-PAK.
	ECMFMC	Ringtype meter cover replacement for Power Mod type (W)MM Ringstyle residential meter stacks and WP, WEP, and WPC series ringstyle Uni-PAK. Do not confuse this kit with the Conversion kit. If going from ringless to ring type cover, a conversion kit is required, not a replacement kit.
	ECMFMCr	Ringless meter cover replacement for Power Mod type (W)MM ringless residential meter stacks and WP and WPC series ringless Uni-PAK. Do not confuse this kit with the Conversion kit. If going from ring to ringless type cover, a conversion kit is required, not a replacement kit.





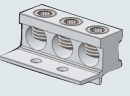
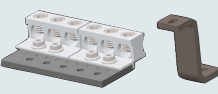

Power Mod and Uni-PAK

Multifamily Metering Accessories and Replacement Parts

Accessory	Catalog number	Description
	ECMMRLCK	Power Mod and Uni-PAK ring to ringless cover conversion kit for type (W)MM meter stacks and WP series Uni-PAK.
	ECMMRCK	Power Mod and Uni-PAK ringless to ring cover conversion kit for type (W)MM meter stacks and WP series Uni-PAK.
	ECMFC	Bottom pull cover. Blank cover below the socket positions. For (W)MM Power Mod and WP, WEP, and WPC Uni-PAK.
	ECMFPS	Quick phase "Z" strap replacement for Power Mod type (W)MM meter stacks and series WP, WEP, and WPC Uni-PAK.
	ECWMLPS	Phase Straps for Lever bypass stacks. For use on 3-PH-In/1-PH-out, 125A, (W)ML stacks only. Only applicable to field phaseable units. Includes (2) line straps, (2) phase straps and (6) 1/4-20 hex nuts.
	ECMMFSP400	400A Power Mod metering switch main fuse bus replacement kit. Includes: bus plates, screws, hex nuts, washers and bolts (used to mount fuse in the module). For use with WS, WES and WXS switches.
	ECMMFSP600	600A Power Mod metering switch main fuse bus replacement kit. Includes: bus plates, screws, hex nuts, washers and bolts (used to mount fuse in the module). For use with WS, WES and WXS switches.
	ECMMFSP800	800A Power Mod metering switch main fuse bus replacement kit. Includes: bus plates, screws, hex nuts, washers and bolts (used to mount fuse in the module). For use with WS, WES and WXS switches.
	ECAFL	(10) Arc flash labels.
	ECMMQRSCR	Power Mod QR and QJ 3-phase breaker mounting and strap screws. Kit contains (2) #10-32 x 2-7/16" screws and (3) 1/4-20 x 5/8" screws. For use on (W)ML and WMT Power Mod.
	ECMMGBE	Power Mod ground lug bar assembly kit. Can be used on the following modules: WT_PU (1600-2400A), WTB (2000-2400A), WBT324X_(all), BFT (all). Adds 4 rows of NEMA stud kits to the ground bar. Can be used in bottom or top position. Includes 1 extension assembly and screws. In feed-through devices, a second kit may be required for the outgoing grounds as well.
	ECGLK3300	300 kcmil ground lug extension kit. Includes (3) lugs for ground. May be used on WB (up to 1200A), WBT, WTB and WT_PU (1600-2400A).
	ECGLK6300	300 kcmil ground lug extension kit. Includes (6) lugs for ground. May be used on WB (up to 1200A), WBT, WTB, WET and WT_PU (400-2400A). Included bonding strap is only necessary for the WB series.

Power Mod and Uni-PAK

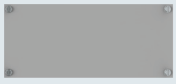
Multifamily Metering Accessories and Replacement Parts

Accessory	Catalog number	Description
	ECMFMC10	Ring-type meter cover for (W)MN stacks only.
	ECWML10	Replacement ringless meter socket cover for use on 125A (W)ML, (W)MLZ and (W)MLZF stacks that are single-phase out only.
	ECWMLC	Bottom pull cover. Replacement part only. Only to be used on 125A (W)ML.
	ECWMLZEP	Secondary cross bus side cover plate. Replacement part only. For use on fusible meter stacks (W)MLZ(F).
	ECWMLZBP	Bottom removable endwall plate for (W)MLZ(F) stacks. Replacement part only.
	ECWMLZFBUS	Secondary cross bus assembly for (W)MLZ(F) stacks. These 3 bus bars are installed toward the base of the (W)MLZ stack to create a secondary bus connection to an adjacent (W)MLZF or (W)MLZ stack. Includes (3) bus bars and (6) hex nuts. Replacement part only.

Replacement Breaker Covers

These replacement metal covers (breaker side) are for WML, WMT and other three-phase modules manufactured prior to February 5, 2016. Prior to this date, these stacks were made to be only compatible with the QJ breaker. The QR breaker replaced the QJ breaker, so for these modules to be compatible with the QR breaker they will need a cover conversion kit from the table below. Stacks manufactured after February 5, 2016 will accept both QJ and QR breakers without needing a cover kit.

Accessory	Catalog Number	Description
	ECWML3BC1	RX breaker side metal door cover for WML13225RJ accepts QR and QJ breaker.
	ECWML3BC2	RX breaker side metal door cover for WML23225RJ accepts QR and QJ breaker.
	ECWML3BC3	RX breaker side metal door cover for WML33225RJ accepts QR and QJ breaker.
	ECWML3BC4	RX breaker side metal door cover for WML43225RJ accepts QR and QJ breaker.
	ECML3BC1	RX breaker side metal door cover for ML13225RJ accepts QR and QJ breaker.
	ECML3BC2	RX breaker side metal door cover for ML23225RJ accepts QR and QJ breaker.
	ECML3BC3	RX breaker side metal door cover for ML33225RJ accepts QR and QJ breaker.
	ECML3BC4	RX breaker side metal door cover for ML43225RJ accepts QR and QJ breaker.
	ECW3MMUBC1	RX breaker side metal door cover for W3MM1200U accepts QR and QJ breaker.
	ECW3MMUBC2	RX breaker side metal door cover for W3MM2200U accepts QR and QJ breaker.
	ECW3MMUBC3	RX breaker side metal door cover for W3MM3200U accepts QR and QJ breaker.
	ECW3MMUBC4	RX breaker side metal door cover for W3MM4200U accepts QR and QJ breaker.
	ECW3MMBC1	RX breaker side metal door cover for W3MM1200 accepts QR and QJ breaker.
	ECW3MMBC2	RX breaker side metal door cover for W3MM2200 accepts QR and QJ breaker.
	ECW3MMBC3	RX breaker side metal door cover for W3MM3200 accepts QR and QJ breaker.
	ECW3MMBC4	RX breaker side metal door cover for W3MM4200 accepts QR and QJ breaker.
	ECWMT3BC1	RX breaker side metal door cover for WMT13225J accepts QR and QJ breaker.
	ECWMT3BC2	RX breaker side metal door cover for WMT23225J accepts QR and QJ breaker.
	ECWMT3BC3	RX breaker side metal door cover for WMT33225J accepts QR and QJ breaker.
	ECMT3BC1	RX breaker side metal door cover for MT13225J accepts QR and QJ breaker.
	ECMT3BC2	RX breaker side metal door cover for MT23225J accepts QR and QJ breaker.
	ECMT3BC3	RX breaker side metal door cover for MT33225J accepts QR and QJ breaker.
	ECW3USSBC1	RX breaker side metal door cover for W3MM1225USS accepts QR and QJ breaker.
	ECW3USSBC2	RX breaker side metal door cover for W3MM2225USS accepts QR and QJ breaker.
ECW3USSBC3	RX breaker side metal door cover for W3MM3225USS accepts QR and QJ breaker.	

Power Mod and Uni-PAK

Tenant Circuit Breakers



QS2100



QR23B225



Q260



Q360

Amperage	10K AIC	22K AIC	42K AIC	65K AIC	100K AIC
	Type QP	Type QPH	—	Type HQP	Type HQPH

For use in 125 Amp and 225^① Amp single phase output WMM, WML, WMT, WP, WPC, WEP, WPL metering^③

Amperage	Q260	Q260H	Q260HH	Q260HH	—
60	Q260	Q260H	Q260HH	Q260HH	—
70	Q270	Q270H	Q270HH	Q270HH	—
80	Q280	Q280H	Q280HH	Q280HH	—
90	Q290	Q290H	Q290HH	Q290HH	—
100	Q2100	Q2100H	Q2100HH	Q2100HH	HQ2100H
110	Q2110	Q2110H	Q2110HH	Q2110HH	—
125	Q2125	Q2125H	Q2125HH	Q2125HH	HQ2125H

For use in 100 Amp, 3- phase output WML meter stacks only

Amperage	Q360	Q360H	Q360HH	Q360HH	—
60	Q360	Q360H	Q360HH	Q360HH	—
70	Q370	Q370H	Q370HH	Q370HH	—
80	Q380	Q380H	Q380HH	Q380HH	—
90	Q390	Q390H	Q390HH	Q390HH	—
100	Q3100	Q3100H	Q3100HH	Q3100HH	—

For use in 225^① Amp single phase output WMM, WML, WMT, WP, WPC, WEP, WPL metering^③

Amperage	Type QS ^②	Type QSH ^②	Type QSHH	Type HQS ^②	Type HQSH ^②
100	QS2100	QS2100H	QSH2100	QSH2100H	HQS2100H
125	QS2125	QS2125H	QSH2125	QSH2125H	HQS2125H
150	QS2150	QS2150H	QSH2150	QSH2150H	HQS2150H
175	QS2175	QS2175H	QSH2175	QSH2175H	HQS2175H
200	QS2200	QS2200H	QSH2200	QSH2200H	HQS2200H
225	QS2225	QS2225H	QSH2225	QSH2225H	HQS2225H

For use in 225 Amp 3-phase output WML and WMT meter stacks only

Amperage	10K AIC	25K AIC	65K AIC	100K AIC
	Type QR2	Type QRH2	Type HQR2	Type HQR2H
100	QR23B100	QRH23B100	HQR23B100	HQR23B100H
125	QR23B125	QRH23B125	HQR23B125	HQR23B125H
150	QR23B150	QRH23B150	HQR23B150	HQR23B150H
175	QR23B175	QRH23B175	HQR23B175	HQR23B175H
200	QR23B200	QRH23B200	HQR23B200	HQR23B200H
225	QR23B225	QRH23B225	HQR23B225	HQR23B225H

① QP Breakers will fit in 225A WMM, WML, and WMT meter stacks.

② QS series rates with Murray circuit breakers.

③ Breaker selection (when applied to Uni-PAK) applies to WP, WPC, WEP, WPL, Uni-PAK metering only. QS breakers will not fit in SP or MP series.

Power Mod and Uni-PAK

Tenant Circuit Breakers

QS Breaker^①

Power Mod's core offering of residential Meter Stacks, type WMM, offers the widest product offering and flexibility in the industry. Each meter stack houses the QuickSystem features to maximize productivity and minimize labor costs. To further simplify installation, our 225 Amp meter stacks feature the QS breaker. The QS breaker adds to the Siemens exclusive feature set in our Power Mod product line. Benefits and part numbers include:

- An exclusive side wired design saves wiring space and eliminates difficult "S bends"
- No need for costly filler plates — QS 225 Amp breaker takes the same space as standard 100 Amp QPs
- Single right hand bend wiring - saves time and wire
- Provides 100K AIC flexibility from 100 up to 225 Amps
- 10K to 100K AIC Series Rating

QS Breaker^①

Breaker Type	QS	QSH	QSHH	HQS	HQSH
Amperage	10K AIC	22K AIC	42K AIC	65K AIC	100K AIC
100	QS2100	QS2100H	QSH2100	QS2100HH	HQS2100H
110	QS2110	QS2110H	QSH2110	QS2110HH	HQS2110H
125	QS2125	QS2125H	QSH2125	QS2125HH	HQS2125H
150	QS2150	QS2150H	QSH2150	QS2150HH	HQS2150H
175	QS2175	QS2175H	QSH2175	QS2175HH	HQS2175H
200	QS2200	QS2200H	QSH2200	QS2200HH	HQS2200H
225	QS2225	QS2225H	QSH2225	QS2225HH	HQS2225H



QS Breaker Dimension Drawing

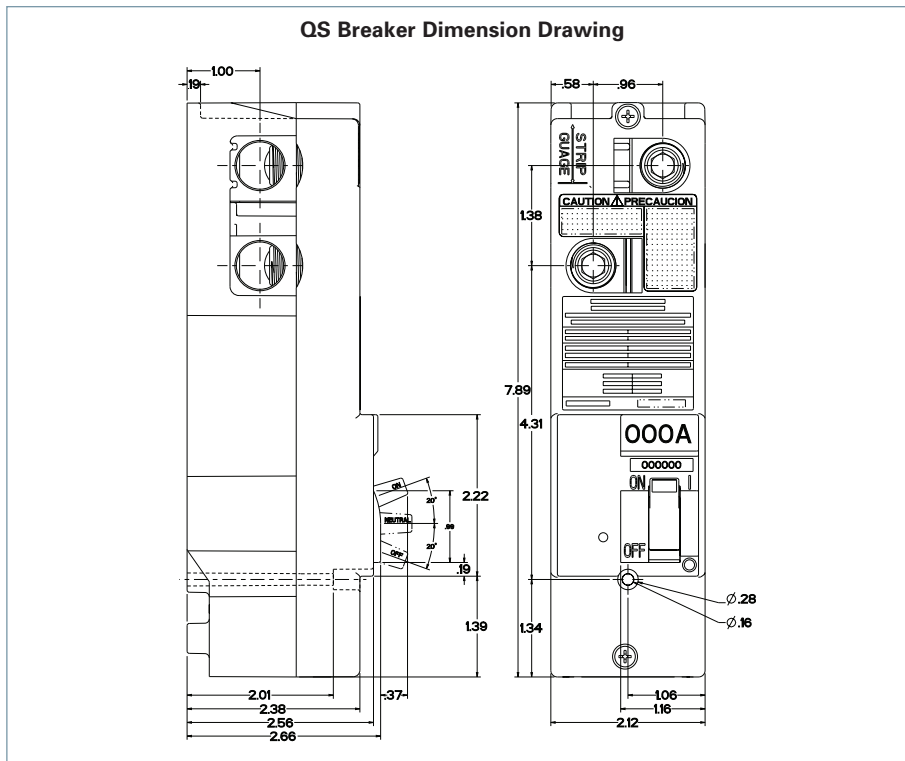

① QS breakers are not compatible with 125A rated stacks and also not compatible with PAK devices with 125A max tenant main ratings.

Uni-PAK Metering

Accessories

Selection

3
METER
CENTERS

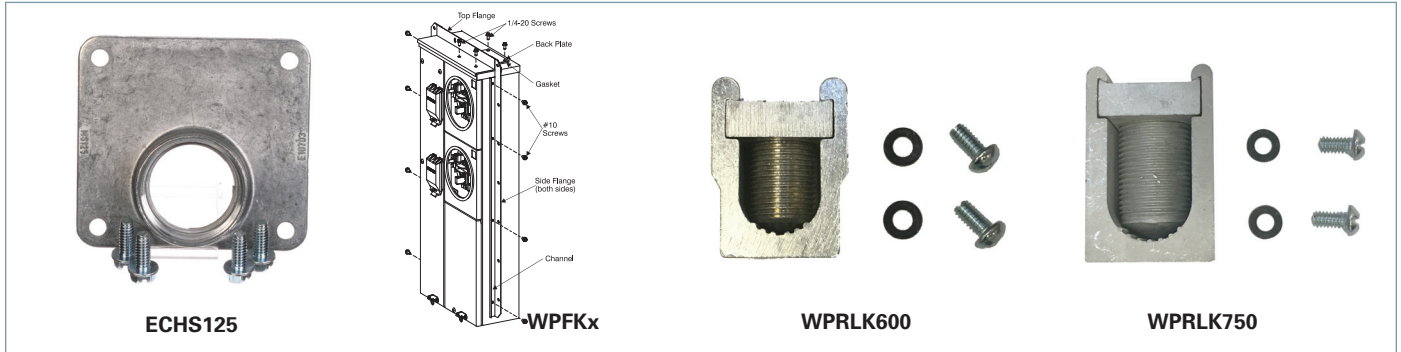

Uni-PAK Lug Kits

Catalog Number	Description
Replacement Factory Installed Lug Kits (WP & WEP Only)	
ECMLK3225	300 KCMIL - For use in devices with 200A rated bus (contains 1 lug assembly)
WPRLK600	600 KCMIL - For use in devices with 300A, 500A, 600A or 1000A rated bus (contains 1 lug assembly)
WPRLK750	750 KCMIL- For use in devices with 400A or 800A rated bus (contains 1 lug assembly)

Uni-PAK Alternate Lug Kits (WP ONLY)

WPLK2400	400A Bus Lug Kit (2) #4-250
WPLK2600	600A Bus Lug Kit (3) #6-250

Uni-PAK NEMA Stud Kits (WEP ONLY) ^⑥

WPSK400	Fits 300 - 400A
WPSK600	Fits 500 - 600A
WPSK800	800A
WPSK1000	1000A

Lug Kits (WPL ONLY) ^⑤

H56476	3/0-800 kcmil
H60162	(2) 1/0-250 kcmil OR (1) #4-600 kcmil
H68752-1	(3) #6-250 kcmil
H56732	(2) #4-350 kcmil
H56732-M	(2) #4-500 kcmil

Semi-flush Mounting Kits (WEP only)

Flange Kit Number	Designed for use with:
WPFK1	WEP2211, WTEG2211
WPFK2	WEP3311, WTEG2211
WPFK3	WEP4411, WTEG4411
WPFK4	WEP4511, WTEG4511, WEP4611, WTEG4611
WPFK5	WEP6511, WTEG6511, WEP6611, WTEG6611
WPFK6	WEP4212, WTEG4212
WPFK7	WEP4312, WTEG4312
WPFK8	WEP4412, WTEG4412
WPFK9	WEP6412, WTEG6412
WPFK10	WEP6512, WTEG6512, WEP6612, WTEG6612
WPFK11	WEP10612, WTEG10612
WPFK12	WEP5411, WTEG5411
WPFK13	WEP8612, WTEG8612

Uni-PAK Accessories

Catalog Number	Description
Type "HD" Conduit Hubs	
EC56854	2" Conduit Hub ^④
EC56855	2½" Conduit Hub ^④
EC56856	3" Conduit Hub
EC56857	3½" Conduit Hub
EC56858	4" Conduit Hub
EC56933S	Closure Plate
Type "RX" Conduit Hubs	
EC38594	¾" Conduit Hub
EC38596	1" Conduit Hub
EC38597	1¼" Conduit Hub
EC38598	1½" Conduit Hub
EC38599	2" Conduit Hub
EC38600	2½" Conduit Hub
EC38595	Closure Plate
EC9747-1113	Adapter plate for HD/RX ^③
Cover Plate	
ECPP	Plastic Ring Style ^①
ECCP3	Plastic Ringless Style

① Not for use on lever bypass units.
 ② Order NSK600 and PLK600 kits for use with 800 Amp PAK. CU Cable only approved with 800A device.
 ③ Use Adapter plate with RX hubs for PAK units.
 ④ These items made of Adapter plate and equivalent RX hub.

⑤ Lug kits should be chosen based on the wire size being run to the unit. Wire should be sized according to the National Electrical Code. Lugs are sold separately. On 400-600A applications, a total of 3 lugs are required to wire the line side of the device. Lugs sold in packs of 2 pieces.
 ⑥ To be used with compression or mechanical lugs. Power Mod type LK_N2(E) lug kits can be used. View cutsheet for specific lug kit options.

Meter Centers

OBSOLETE Modular Metering Replacement Parts Kits

Selection

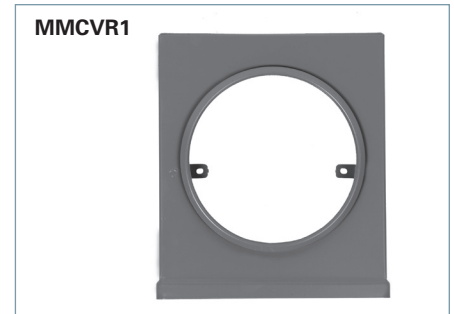
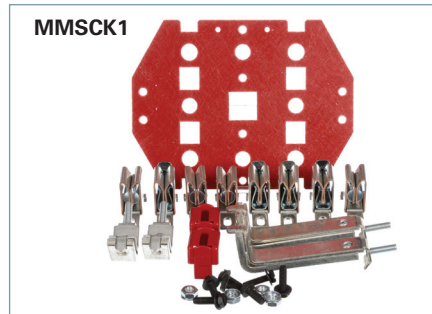
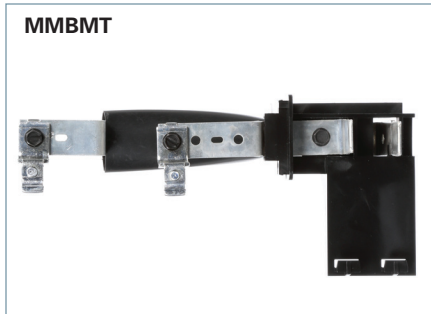

Part Number	Description	Contents
Breaker Covers		
GMBC1 ^{①②}	Group Metering Breaker Cover - 125Amp Positions	One Top and bottom black plastic breaker cover piece, 1 gasket, and a locking clip
GMBC2 ^{①②}	Group Metering Breaker Cover - 200Amp Positions	Top and bottom black plastic breaker cover pieces, gasket, and locking clip
Meter Covers		
MMCVR1 ^①	Modular Metering Covers 125A Ring Style	1 Ringstyle meter cover welded with support brackets and painted
MMCVR1R ^①	Modular Metering Covers 125A Ringless	1 Ringless style meter cover welded with support brackets and painted
MMCVR2 ^①	Modular Metering Covers 200A Ring Style	1 Ringstyle meter cover welded with support brackets and painted
MMCVR2R ^①	Modular Metering Covers 200A Ringless	1 Ringless style meter cover welded with support brackets and painted
MMCVRL0W ^①	Modular Metering Bottom Cover (neutral access cover)	Smallest (bottom) cover on meter stack and screw included
MMCVRSCR	Modular Metering Cover Screws	Bag of 10 screws
PAKMCVRR ^②	Tenant cover for Ring Style Uni-Pak Meter Center	1 Ringstyle meter cover welded with support brackets and painted
PAKMCVRL ^②	Tenant cover for RingLess Uni-Pak Meter Center	1 Ringless style meter cover welded with support brackets and painted



Meter Socket/Breaker Mounting		
MMBMT1 ^①	Modular Metering Breaker Mounting S/A 125A	Breaker mounting assembly for 125A stacks
MMBMT2 ^①	Modular Metering Breaker Mounting S/A 200A	Breaker mounting assembly for 200A stacks
MMSCK1 ^{①②}	Modular Metering Meter Socket Assembly 125A	Meter Socket assembly includes jaws, straps, and hardware – see picture above
MMSCK2 ^{①②}	Modular Metering Meter Socket Assembly 200A	
MMSRPK ^③	Replacement parts for 125A pre-1991 modular metering (see tip below)	Meter and breaker mounting assembly. Contains 1 red plastic meter base, 4 jaws and connecting line straps for the breaker mount.

Loose Parts Kits^①		
MMPK11	Modular Metering Loose Parts Kit 125A 1 PHASE	All loose screw bags, labels, instruction sheet and aluminum sealing ring (No SBJ)
MMPK13	Modular Metering Loose Parts Kit 125A 3 PHASE	
MMPK21	Modular Metering Loose Parts Kit 200A 1 PHASE	
MMPK23	Modular Metering Loose Parts Kit 200A 3 PHASE	

Miscellaneous Replacement Parts		
ECMM5J ^①	5th Jaw Kit	Contains 1 fifth jaw assembly, enough for one meter socket
ECHBK ^①	Horn Bypass Kit	Contains 4 horn bypasses, enough for one meter socket
ECCP3U ^{①④}	4" to 2" Filler Plate	Used beneath breaker cover to fill in the gaps on the sides of a 2-pole breaker used in a 4-inch slot

- ① Fits modular metering made from 1992-2009 and PAK devices from 1992-2003 (ie. 2nd Generation).
- ② Fits PAK devices from 2004-2011
- ③ Fits 125A modular metering and PAK made from 1980-1991 only. Not compatible with EUSERC style PAK (EUSERC versions contain suffix W/WF). No other replacement parts available (ie. 1st Generation).
- ④ Not for use on lever bypass units.

Brief history of residential Power Mod products

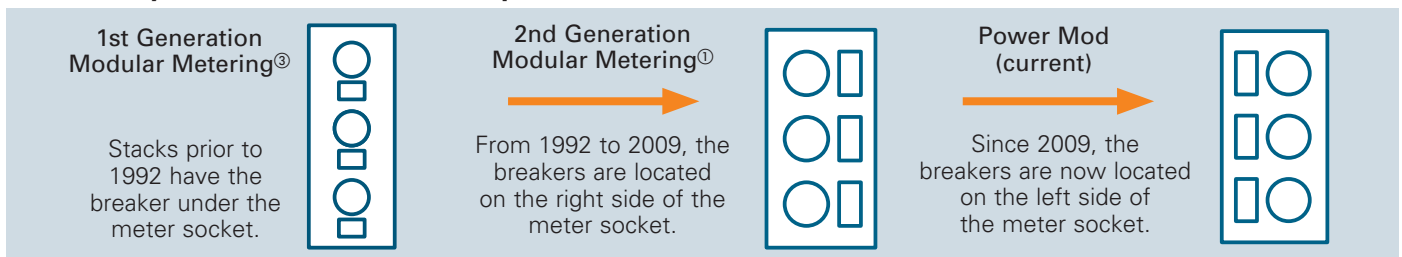

Power Mod

WMM Residential Meter Stacks Rating Charts

Use the tables below to determine the correct combination of equipment and circuit breakers for the available fault current. This chart provides series rating information for the most common applications. For a complete series rating chart please contact your local sales office.

Available fault current RMS symmetrical amps at 120/240 volts maximum	Main Modules [Ⓞ]	Meter module branch circuit breakers	Load center branch circuit breakers
to 10,000	Series WB, WB_U, WBM, WBM_U WEB, WEB_U, WEBM, WEBM_U WS_U, WES_U, WTB_U, WET_U, WXB, WXB_U WXBM, WXBM_U, WBTM, WBTM_U, BFTM and BFTM_U	QP, QPH, HQP, HQPH (2 pole, 15–125A)	QP, QPH, HQP, QT, QAF, QAFH, QPF, QPHF, QE, QEH
		QS, QSH, QSHH, HQS, HQSH (2 pole, 100–225A)	
to 22,000	Series WB, WB_U, WBM, WBM_U WEB, WEB_U, WEBM, WEBM_U WXB, WXB_U, WXBM, WXBM_U, WBTM, WBTM_U, BFTM and BFTM_U	QPH, HQP, HQPH (2 pole, 15–125A)	QP, QPH, HQP, QT, QAF, QAFH, QPF, QPHF, QE, QEH
		QS, QSH, QSHH, HQS, HQSH (2 pole, 100–225A)	
	Series WS_U, WES_U WXS	QPH, HQP, HQPH (2 pole, 15–125A)	
		QS, QSH, QSHH, HQS, HQSH (2 pole, 100–225A)	
	Series WTB_U, WET_U	QPH, HQP, HQPH (2 pole, 15–125A)	
		QSH, QSHH, HQS, HQSH (2 pole, 100–225A)	
to 42,000	Series WB, WB_U, WBM, WBM_U WEB, WEB_U, WEBM, WEBM_U WXB, WXB_U, WXBM, WXBM_U, WBTM, WBTM_U, BFTM and BFTM_U	QPH, HQP, HQPH (2 pole, 15–125A)	QP, QPH, HQP, QT, QAF, QAFH, QPF, QPHF, QE, QEH
		QS, QSH, QSHH, HQS, HQSH (2 pole, 100–225A)	
	Series WS_U, WES_U WXS	QPH, HQP, HQPH (2 pole, 15–125A)	
		QS, QSH, QSHH, HQS, HQSH (2 pole, 100–225A)	
	Series WTB_U, WET_U	HQP, HQPH (2 pole, 15–125A)	
		QSHH, HQS, HQSH (2 pole, 100–225A)	
to 65,000	Series WB, WB_U, WBM, WBM_U WEB, WEB_U, WEBM, WEBM_U WXB, WXB_U	QPH, HQP, HQPH (2 pole, 15–125A)	QP, QPH, HQP, QT, QAF, QAFH, QPF, QPHF, QE, QEH
		QS, QSH, QSHH, HQS, HQSH (2 pole, 100–225A)	
	Series WS_U, WES_U WXS	QPH, HQP, HQPH (2 pole, 15–125A)	
		QS, QSH, QSHH, HQS, HQSH (2 pole, 100–225A)	
	Series WTB_U, WET_U	HQP, HQPH (2 pole, 15–125A)	
		HQS, HQSH (100–225A)	
to 100,000	Series WB_U, WBM_U, WEB_U, WEBM_U, WS_U, WES_U, WXB_U, WXS, WXBM_U, WBTM_U and BFTM_U	HQPH (2 pole, 100–125A)	QP, QPH, HQP, QT, QAF, QAFH, QPF, QPHF, QE, QEH
		QS, QSH, QSHH, HQS, HQSH (2 pole, 100–225A)	
	Series WTB_U, WET_U	HQPH (2 pole, 100–125A)	
	HQSH (100–225A)		

[Ⓞ] Service Entrance Modules:

WB, WEB, WXB, WBT and BFT have 65k AIC breakers factory installed [(JXD2-A, JXD6-A) (LXD6-A) (MXD6) (NXD6) (PXD6) (RXD6)]
 WB_U, WEB_U, WXB_U, WBT_U and BFT_U have 100k AIC breakers factory installed [(HJXD6-A) (HLXD6-A) (HMXD6) (HNXD6) (HPXD6) (HRXD6)]
 WBM, WEBM, WXBM, WBTM and BFTM have 65k AIC DAS breakers factory installed [(SND6) (SPD6)]
 WBM_U, WEBM_U, WXBM_U, WBTM_U and BFTM_U have 100k AIC DAS breakers factory installed [(SHND6) (SHPD6)]
 WS_U and WES_U are fused switches (Class T – 300 volt)
 WTB_U and WET_U have NO overcurrent protection

Power Mod

WML and WMT Commercial Meter Stacks Rating Charts

Use the tables below to determine the correct combination of equipment and circuit breakers for the available fault current. This chart provides series rating information for the most common applications. For a complete series rating chart please contact your local sales office.

Available fault current RMS symmetrical amps at 120/240V max 1-phase, 240V max 3-Phase	Main Modules ^①	Meter module branch circuit breakers	Load center branch circuit breakers
to 10,000	Series WB, WB_U, WBM, WBM_U WEB, WEB_U, WEBM, WEBM_U WS_U, WES_U, WTB_U, WET_U, WXB, WXB_U, WXS, WXBM, WXBM_U, WBTM, WBTM_U, BFTM and BFTM_U	QP, QPH, HQP, HQPH (2 pole,15–125A) QS, QSH, QSHH, HQS, HQSH (2 pole,100-225A)	QP, QPH, HQP, QT, QAF, QAFH, QPF, QPHF, QE, QEH
		QP, QPH, HQP (3 pole,15–100A)	
		QR2, QRH2, HQR2, HQR2H (3 Pole, 100–225A)	
		JXD2-A, JD6-A, JXD6-A (2 and 3 pole, 200–400A)	
		LD6-A, LXD6-A (2 and 3 pole, 600A)	
to 22,000	Series WB, WB_U, WBM, WBM_U WEB, WEB_U, WEBM, WEBM_U, WXB, WXB_U, WXBM, WXBM_U, WBTM, WBTM_U, BFTM and BFTM_U	QPH, HQP, HQPH (2 pole,15–125A) QS, QSH, QSHH, HQS, HQSH (2 pole,100–225A)	QP, QPH, HQP, QT, QAF, QAFH, QPF, QPHF, QE, QEH
		QPH, HQP (3 pole,15–100A)	
		QR2, QRH2, HQR2, HQR2H (3 Pole, 100–225A)	
		QPH, HQP, HQPH (2 pole,15–125A) QS, QSH, QSHH, HQS, HQSH (2 pole,100–225A)	
	Series WS_U, WES_U WXS	QPH, HQP (3 pole,15–100A)	
		QR2, QRH2, HQR2, HQR2H (3 Pole, 100–225A)	
		Series WTB_U WET_U	
	QPH, HQP (3 pole,15–100A)		
	QRH2, HQR2, HQR2H (3 Pole, 100–225A)		
	to 25,000	Series WB, WB_U, WBM, WBM_U WEB, WEB_U, WEBM, WEBM_U WS_U, WES_U, WTB_U, WET_U, WXB, WXB_U, WXS, WXBM, WXBM_U, WBTM, WBTM_U, BFTM and BFTM_U	
LD6-A, LXD6-A (2 and 3 pole, 600A)			
to 42,000	Series WB, WB_U, WBM, WBM_U, WEB, WEB_U, WEBM, WEBM_U, WXB, WXB_U, WXBM, WXBM_U, WBTM, WBTM_U, BFTM and BFTM_U	QPH, HQP, HQPH (2 pole,15–125A) QS, QSH, QSHH, HQS, HQSH (2 pole,100–225A)	QP, QPH, HQP, QT, QAF, QAFH, QPF, QPHF, QE, QEH
		QPH, HQP (3 pole,15–100A)	
		QR2, QRH2, HQR2, HQR2H (3 Pole, 100–225A)	
		QPH, HQP, HQPH (2 pole,15–125A) QS, QSH, QSHH, HQS, HQSH (2 pole,100–225A)	
	Series WS_U, WES_U WXS	QPH, HQP (3 pole,15–100A)	
		QR2, QRH2, HQR2, HQR2H (3 Pole, 100–225A)	
		Series WTB_U WET_U	
	HQP (3 pole,15–100A)		
	HQR2, HQR2H (3 Pole, 100–225A)		

① Service Entrance Modules:

WB, WEB, WXB, WBT and BFT have 65k AIC breakers factory installed [(JXD2-A, JXD6-A) (LXD6-A) (MXD6) (NXD6) (PXD6) (RXD6)]
 WB_U, WEB_U, WXB_U, WBT_U and BFT_U have 100k AIC breakers factory installed [(HJXD6-A) (HLXD6-A) (HMXD6) (HNXD6) (HPXD6) (HRXD6)]
 WBM, WEBM, WXB, WBTM and BFTM have 65k AIC DAS breakers factory installed [(SND6) (SPD6)]
 WBM_U, WEBM_U, WXB_U, WBTM_U and BFTM_U have 100k AIC DAS breakers factory installed [(SHND6) (SHPD6)]
 WS_U and WES_U are fused switches (Class T – 300 volt)
 WTB_U and WET_U have NO overcurrent protection

Power Mod

WML and WMT Commercial Meter Stacks Rating Charts

Use the tables below to determine the correct combination of equipment and circuit breakers for the available fault current. This chart provides series rating information for the most common applications. For a complete series rating chart please contact your local sales office.

Available fault current RMS symmetrical amps at 120/240V max 1-phase, 240V max 3-Phase	Main Modules ^①	Meter module branch circuit breakers	Load center branch circuit breakers to 10,000
to 65,000	Series WB, WB_U, WBM, WBM_U, WEB, WEB_U, WEBM, WEBM_U, WXB, WXB_U, WXB_M, WXB_M_U, WBTM, WBTM_U, BFTM and BFTM_U	QPH, HQP, HQPH (2 pole, 15–125A) QS, QSH, QSHH, HQS, HQSH (2 pole, 100–225A)	QP, QPH, HQP, QT, QAF, QAFH, QPF, QPHF, QE, QEH
		QPH, HQP (3 pole, 15–100A)	
		QR2, QRH2, HQR2, HQR2H (3 Pole, 100–225A)	
	Series WS_U, WES_U WXS	QPH, HQP, HQPH (2 pole, 15–125A) QS, QSH, QSHH, HQS, HQSH (2 pole, 100–225A)	
		QPH, HQP (3 pole, 15–100A)	
		QR2, QRH2, HQR2, HQR2H (3 Pole, 100–225A)	
	Series WTB_U WET_U	HQP, HQPH (2 pole, 15–125A) HQS, HQSH (2 pole, 100–225A)	
		HQP (3 pole, 15–100A)	
		HQR2, HQR2H (3 Pole, 100–225A)	
to 100,000	Series WB_U, WBM_U, WEB_U, WEBM_U, WS_U, WES_U, WXB_M_U, WBTM_U and BFTM_U	HQPH (2 pole, 100–125A)	QP, QPH, HQP, QT, QAF, QAFH, QPF, QPHF, QE, QEH
		QS, QSH, QSHH, HQS, HQSH (2 pole, 100–225A)	
		QR2, QRH2, HQR2, HQR2H (3 Pole, 100–225A)	
	Series WTB_U, WET_U WXB_U, WXS	HQPH (2 pole, 100–125A)	
		HQSH (2 pole, 100–225A)	
		HQR2H (3 Pole, 100–225A)	

① Service Entrance Modules:
 WB, WEB, WXB, WBT and BFT have 65k AIC breakers factory installed [(JXD2-A, JXD6-A) (LXD6-A) (MXD6) (NXD6) (PXD6) (RXD6)]
 WB_U, WEB_U, WXB_U, WBT_U and BFT_U have 100k AIC breakers factory installed [(HJXD6-A) (HLXD6-A) (HMXD6) (HNXD6) (HPXD6) (HRXD6)]
 WBM, WEBM, WXB_M, WBTM and BFTM have 65k AIC DAS breakers factory installed [(SND6) (SPD6)]
 WBM_U, WEBM_U, WXB_M_U, WBTM_U and BFTM_U have 100k AIC DAS breakers factory installed [(SHND6) (SHPD6)]
 WS_U and WES_U are fused switches (Class T – 300 volt)
 WTB_U and WET_U have NO overcurrent protection